



INSTALL GUIDE

2014-2018 MAZDA 3 HATCHBACK PTS AT

DOCUMENT NUMBER

REVISION DATE

20180829

FIRMWARE

ADS-RSA-MA3-[HCX000A]

HARDWARE

HCX000A

ACCESSORIES

ATTENTION: TO COMPLETE THIS INSTALLATION SOME ACCESSORIES MAY BE REQUIRED. VISIT OUR WEBSITE TO SEE ALL THE REQUIRED ACCESSORIES FOR YOUR VEHICLE.

TERMS OF USE

Automotive Data Solutions Inc. ("ADS") products are strictly intended for installation by Certified Technicians who are employed by a registered business specialized in the installation of automotive aftermarket electronics products. Prior to beginning installation of an ADS product in a vehicle, it is the Certified Technician's responsibility to review the most current Product Guide, Install Guide and vehicle-specific notes available in Weblink®. ADS is not responsible for any damages whatsoever, including but not limited to any consequential damages, incidental damages, damages for loss of time, loss of earnings, loss of profit, commercial loss, loss of economic opportunity and the like that may or may not have resulted from the use, misuse, improper installation or operation of its products. ADS reserves itself the right to suspend any Weblink® account without notice and decline to offer technical support to non-Certified Technicians, non-compliant Certified Technicians or end users.



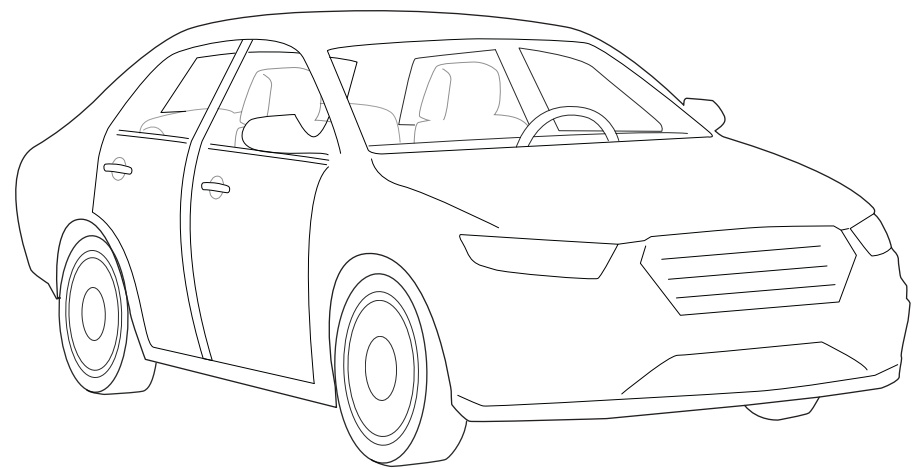
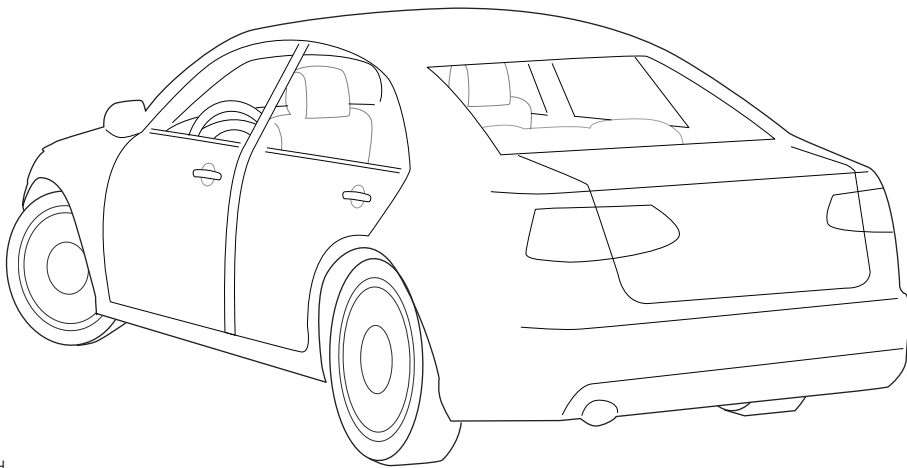
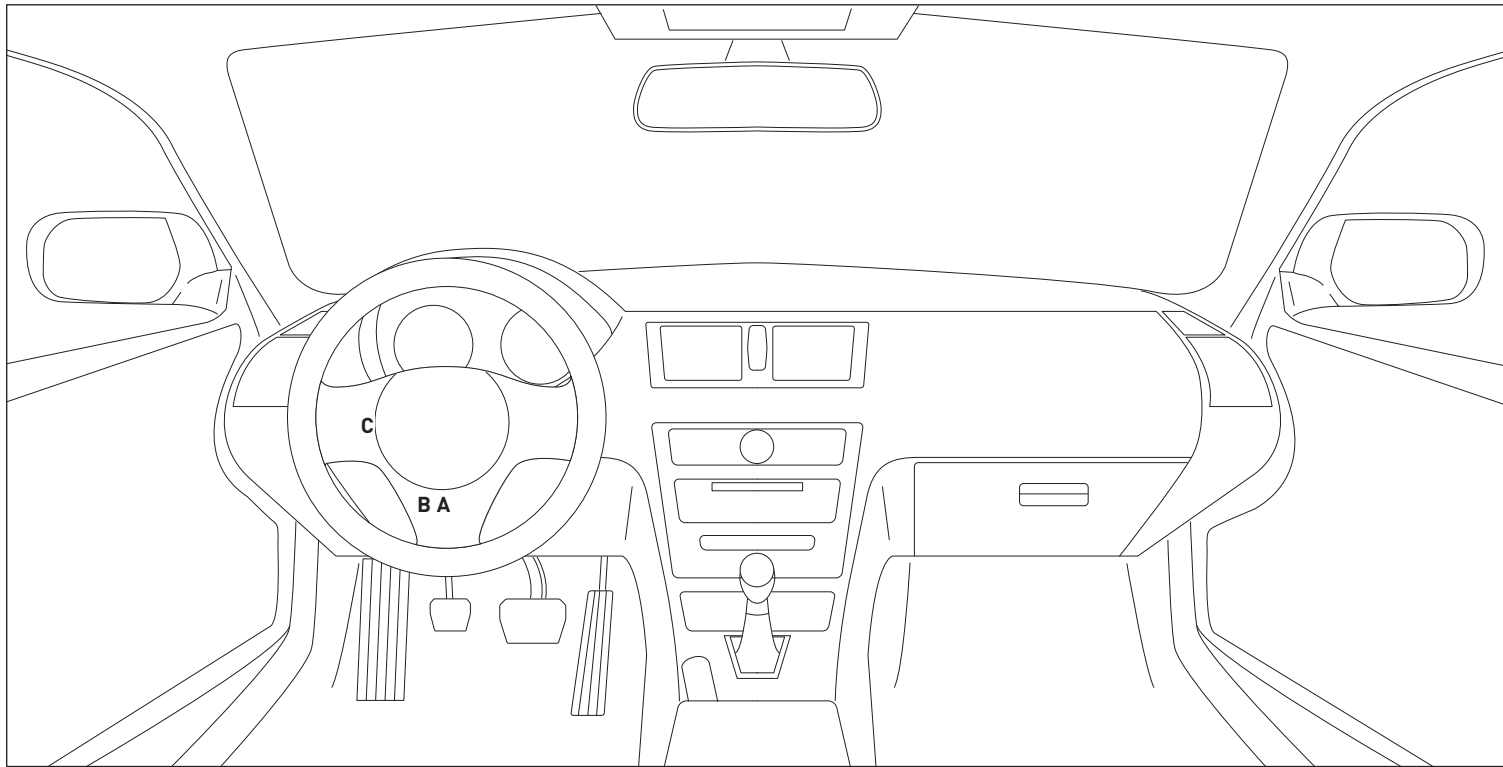

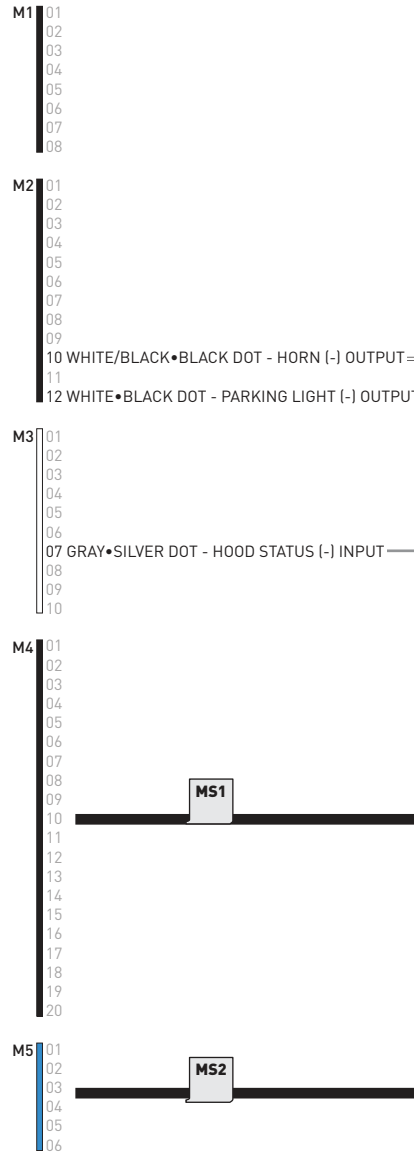
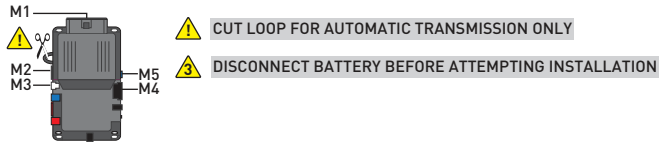

-GRAY•BLUE DOT
-GRAY/BLACK•BLUE DOT
-GRAY/RED•BLUE DOT

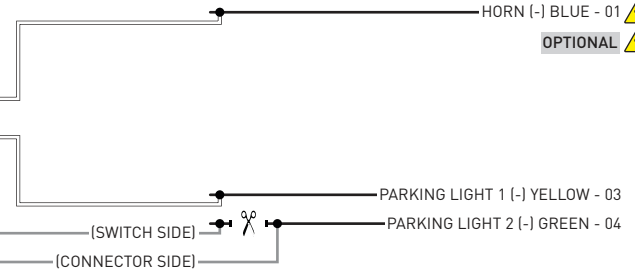
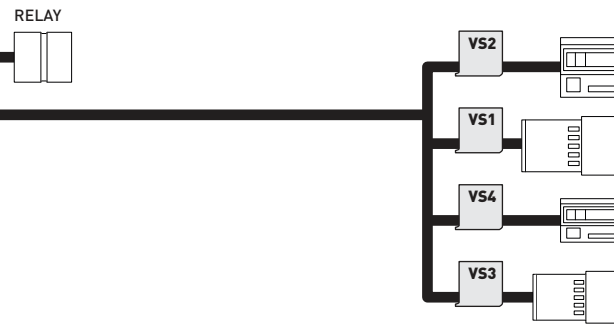

⚠ INSTALL THE SUPPLIED HOOD SWITCH IF THE VEHICLE IS NOT EQUIPPED WITH ONE
SET THE PROGRAMMING OPTION THROUGH WEBLINK AS FOLLOWS:
IN "MENU #7 INPUTS CONFIGURATION",
FOR "4-HOOD INPUT SOURCE" SELECT "1-ANALOG".

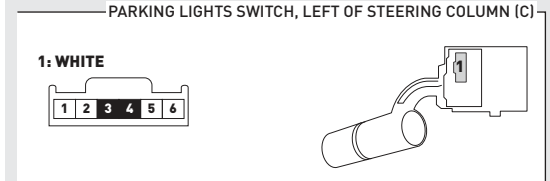
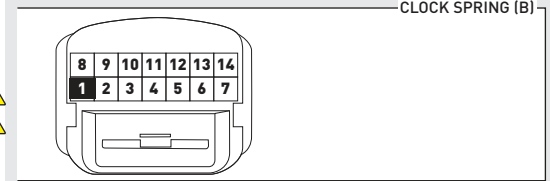
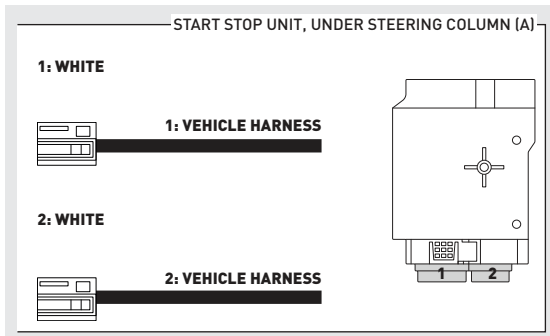

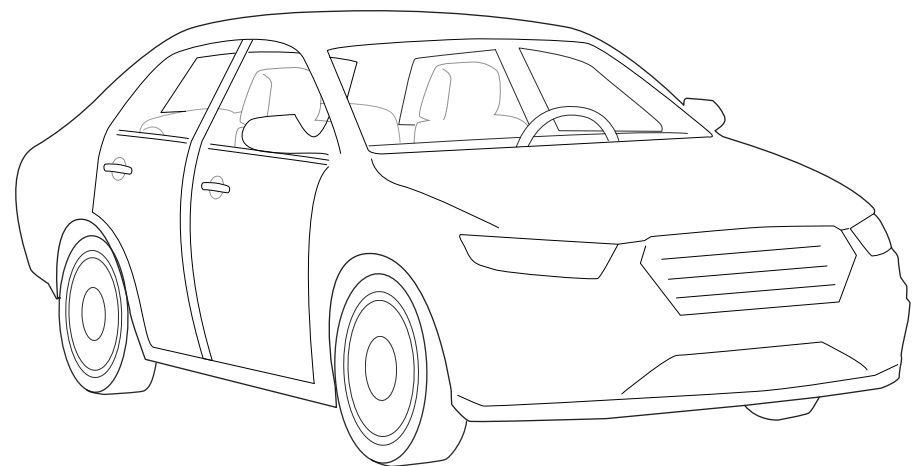
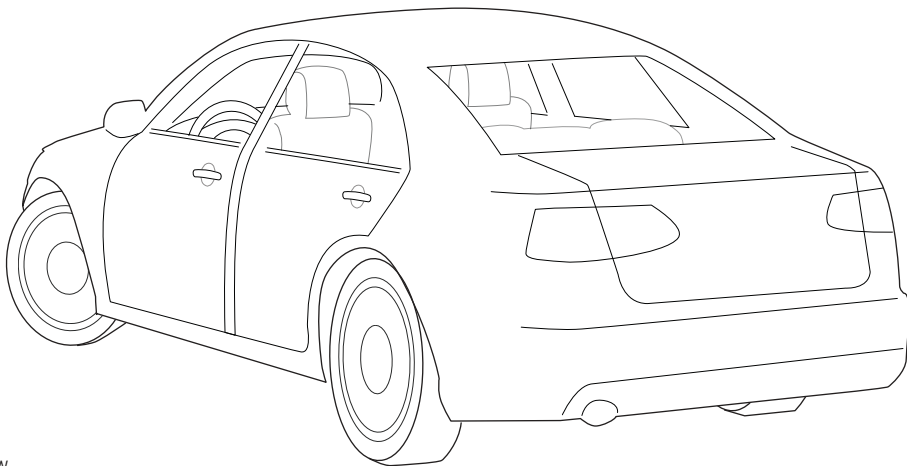
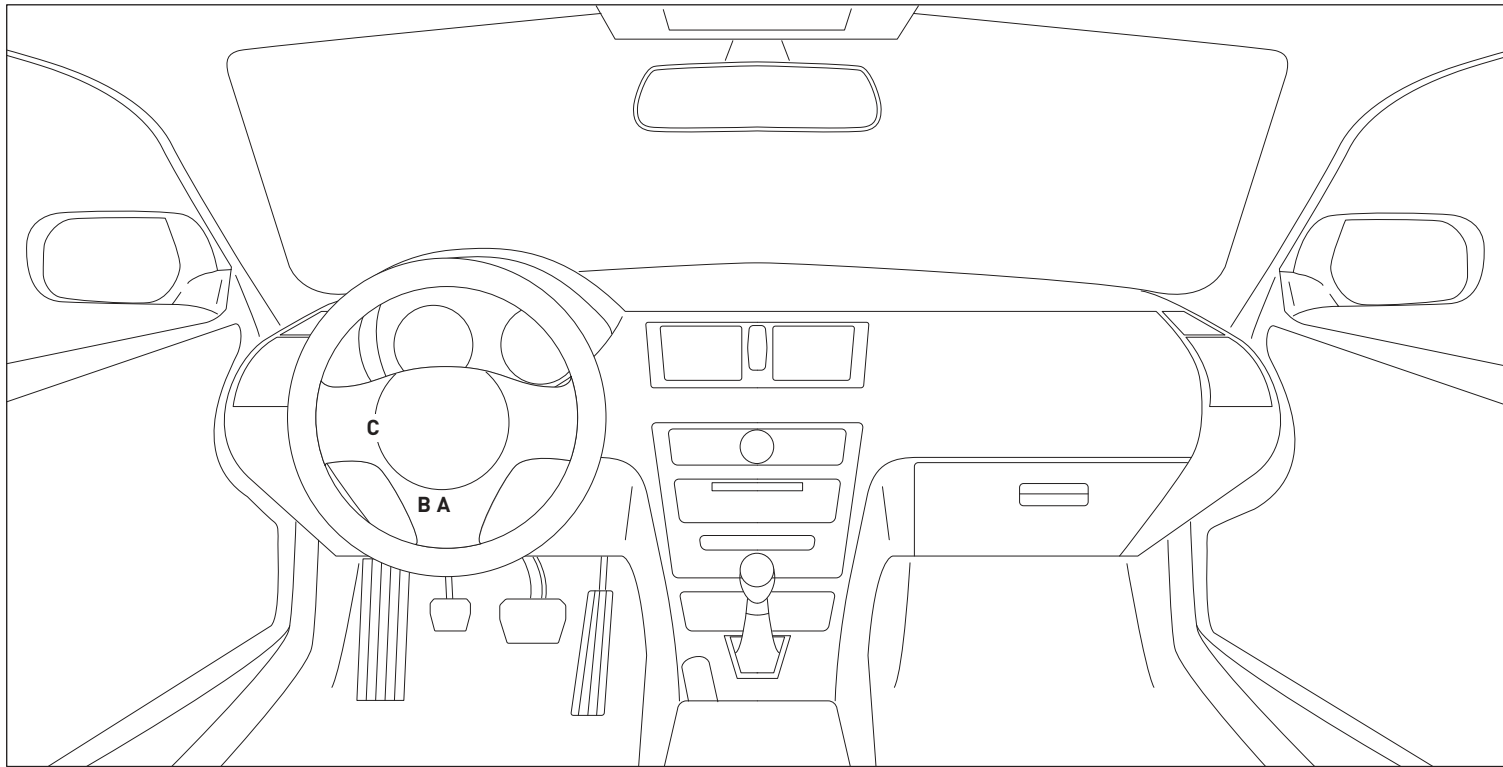

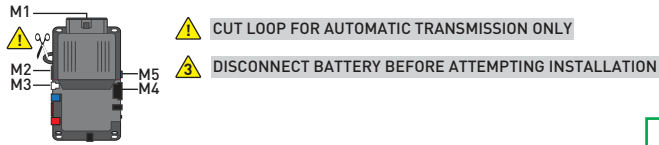

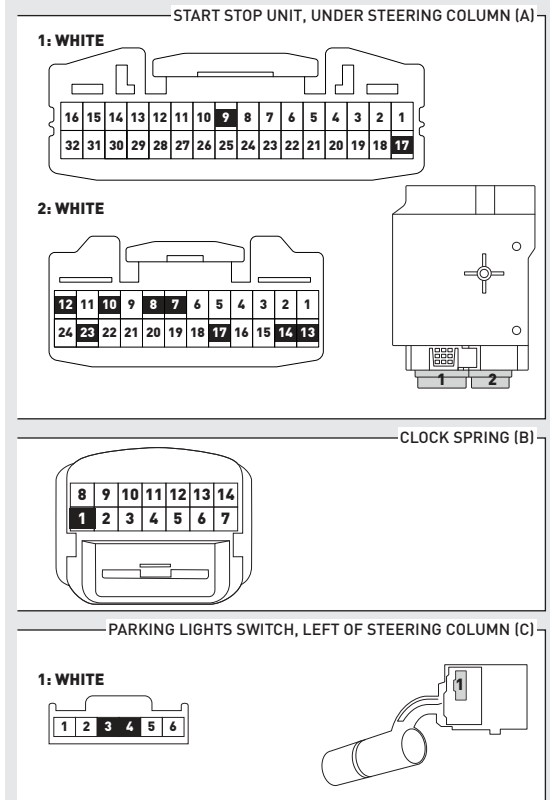
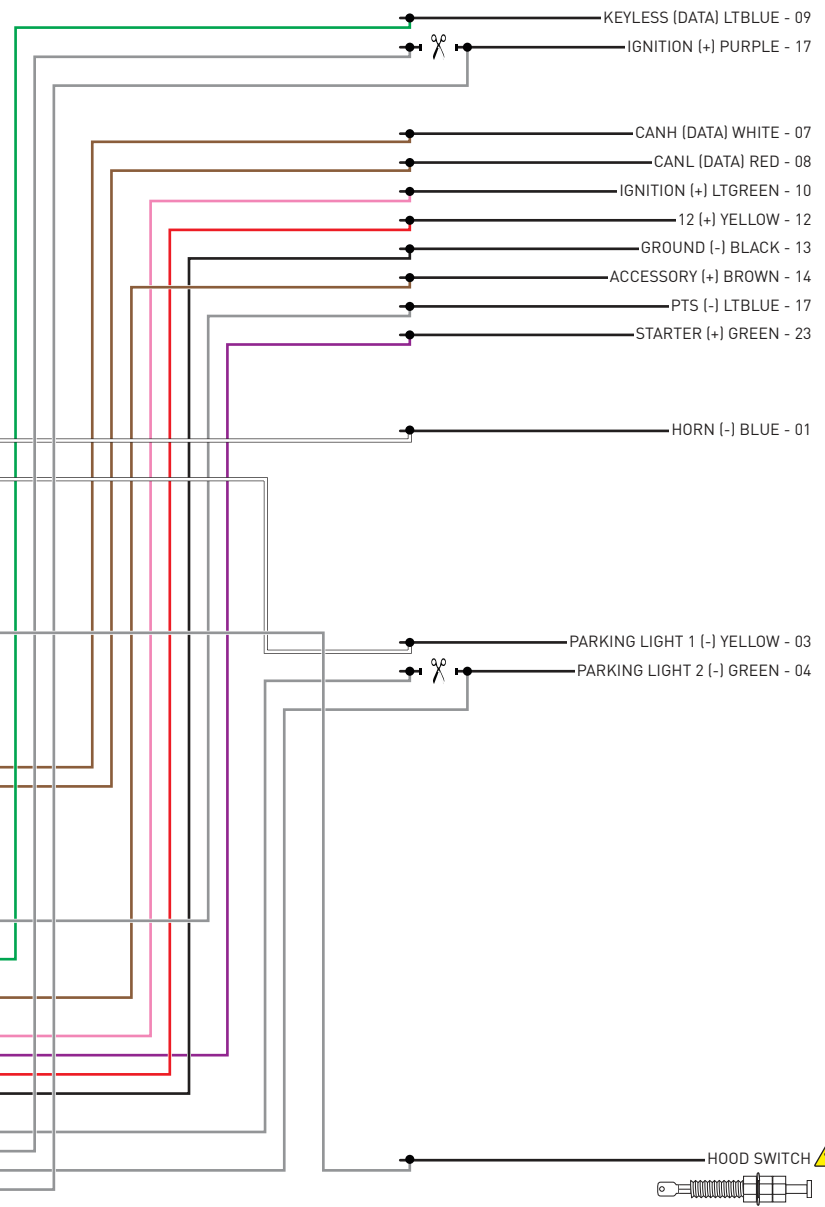

- M1**
 - 01 ORANGE
 - 02 RED
 - 03 PURPLE
 - 04 PINK/WHITE
 - 05 PINK
 - 06 WHITE
 - 07 RED
 - 08 BLACK
- M2**
 - 01 GREEN•BLACK DOT
 - 02 BLUE•BLACK DOT
 - 03 RED/WHITE•BLACK DOT
 - 04 GREEN/WHITE•BLACK DOT
 - 05 GREEN/BLACK•BLACK DOT
 - 06 BLUE/WHITE•BLACK DOT
 - 07 EMPTY
 - 08 WHITE/PURPLE•BLACK DOT
 - 09 PURPLE/BLACK•BLACK DOT
 - 10 WHITE/BLACK•BLACK DOT - HORN (-) OUTPUT
 - 11 BROWN/BLACK•BLACK DOT
 - 12 WHITE•BLACK DOT - PARKING LIGHT 1 (-) OUTPUT
- M3**
 - 01 BROWN•SILVER DOT
 - 02 BLACK/WHITE•SILVER DOT
 - 03 PURPLE•SILVER DOT
 - 04 GREEN•SILVER DOT
 - 05 PURPLE/WHITE•SILVER DOT
 - 06 WHITE/BLUE•SILVER DOT
 - 07 GRAY•SILVER DOT - HOOD STATUS (-) INPUT
 - 08 BLUE•SILVER DOT
 - 09 GRAY/BLACK•SILVER DOT
 - 10 EMPTY
- M4**
 - 01 EMPTY
 - 02 EMPTY
 - 03 BROWN/RED - CANH 1
 - 04 BROWN/YELLOW - CANL 1
 - 05 BLUE/RED
 - 06 BLUE/YELLOW
 - 07 EMPTY
 - 08 ORANGE
 - 09 YELLOW
 - 10 EMPTY
 - 11 GRAY/RED - PTS (-) OUTPUT
 - 12 GRAY/YELLOW
 - 13 GREEN/RED - KEYLESS (DATA)
 - 14 ORANGE/WHITE
 - 15 BROWN - ACCESSORY (+) IN/OUT
 - 16 ORANGE/BLACK
 - 17 PINK - IGNITION (+) IN/OUT
 - 18 PURPLE - STARTER (+) OUTPUT
 - 19 RED - 12V (+) INPUT
 - 20 BLACK - GROUND (-)
- M5**
 - 01 GRAY/BLACK•BLUE DOT - PARKING LIGHT 2 (-) SWITCH SIDE
 - 02 WHITE/BLACK•BLUE DOT - IGNITION (+)
 - 03 GRAY/RED•BLUE DOT - PARKING LIGHT 2 (-) CONNECTOR SIDE
 - 04 WHITE/RED•BLUE DOT - IGNITION (+)
 - 05 GRAY•BLUE DOT
 - 06 WHITE•BLUE DOT



⚠ INSTALL THE SUPPLIED HOOD SWITCH IF THE VEHICLE IS NOT EQUIPPED WITH ONE SET THE PROGRAMMING OPTION THROUGH WEBLINK AS FOLLOWS: IN "MENU #7 INPUTS CONFIGURATION", FOR "4-HOOD INPUT SOURCE" SELECT "1-ANALOG".

>>  WARNING: All vehicle doors must be closed and locked prior to remote start sequence.

01  Set ignition to ON position.

02  Wait, LED 1 will turn solid RED to confirm that the ignition is ON.

03  Wait 10 seconds, LED 1 will flash GREEN rapidly.

04  Set ignition to OFF position.

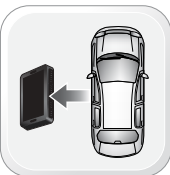
05  WARNING: Disconnect power last. Disconnect module from vehicle.

06  Connect module to computer and proceed with extended programming.

07  Connect power first. Connect module to vehicle.

08  Set ignition to ON position.

09  Wait, LED 1 will turn solid RED to confirm that the ignition is ON.

10  Wait, LED 1 will turn solid GREEN for 2 seconds.

11  Set ignition to OFF position.

>>  If vehicle is equipped with power liftgate: open and close the power liftgate with OEM keyfob.

12  START vehicle for 15 seconds.

13  Press and hold the brake pedal.

14  Press and release the module's programming button.

15  Release the brake pedal.

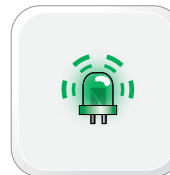
16  Wait, LED 2 will flash GREEN. Module Programming Procedure completed.

>>



All vehicle doors must be closed and locked prior to remote start sequence.

01



Time restriction. Complete steps 2 to 5 within 45 seconds.

02



Press unlock on OEM or aftermarket remote or request switch.

03



Open driver door and enter vehicle.

04



Close driver door.

05



Press and release BRAKE pedal.

06



Take over procedure completed.

>>



Failure to follow procedure will result in vehicle engine shutdown.

CHECKLIST - WITH AFTERMARKET KEYFOB

1	WARNING: Vehicle engine will start many times. Test in a well ventilated area.
2	Close all vehicle doors, hood and trunk.
3	Press the LOCK button once [1x] on the aftermarket keyfob.
	Question 1: Do the doors lock?
<input type="checkbox"/>	YES: Go to next step.
<input type="checkbox"/>	NO: Verify the remote programming, the RF connections and the wired door lock/unlock connections as illustrated in the wiring diagram, if applicable. Repeat the test and call technical support, if the problem persists.
4	Press the UNLOCK button once [1x] on the aftermarket keyfob.
	Question 2: Do the doors unlock?
<input type="checkbox"/>	YES: Go to next step.
<input type="checkbox"/>	NO: Verify the remote programming, the RF connections and the wired door lock/unlock connections as illustrated in the wiring diagram, if applicable. Repeat the test and call technical support, if the problem persists.
5	Press the TRUNK release button once [1x] on the aftermarket keyfob if supported.
	Question 3: Does the trunk or hatch open/unlock?
<input type="checkbox"/>	YES: Close trunk or hatch and go to next step.
<input type="checkbox"/>	NO: Verify the remote programming, the RF connections and the wired trunk/hatch connections as illustrated in the wiring diagram, if applicable. Repeat the test and call technical support, if the problem persists.
6	Press the AUX 1 button once [1x] on the aftermarket keyfob if supported.
	Question 4: Does the driver side sliding door open?
<input type="checkbox"/>	YES: Press the AUX 1 button once [1x] to close the driver sliding door and go to next step.
<input type="checkbox"/>	NO: Verify the remote programming and the RF connections. Repeat the test and call technical support, if the problem persists.
7	Press the AUX 2 button once [1x] on the aftermarket keyfob if supported.
	Question 5: Does the passenger side sliding door open?
<input type="checkbox"/>	YES: Press the AUX 2 button once [1x] to close the passenger sliding door and go to next step.
<input type="checkbox"/>	NO: Verify the remote programming and the RF connections. Repeat the test and call technical support, if the problem persists.
8	Press the START/STOP button once [1x] on the aftermarket keyfob to remote start vehicle.
	Question 6: Does the vehicle remote start?
<input type="checkbox"/>	YES: Go to next step.
<input type="checkbox"/>	NO: Verify the remote programming, the RF connections and check the remote start error codes. Repeat the test and call technical support, if the problem persists.

9	Press the START/STOP button once [1x] on the aftermarket keyfob to shut down vehicle.
	Question 7: Does the vehicle shut down?
<input type="checkbox"/>	YES: Go to next step.
<input type="checkbox"/>	NO: Repeat step. If problem persists, press the brake pedal once [1x] to shut down the vehicle and call technical support.
10	RAP and auto light shutdown test
	Question 8: Did the radio, interior controls and headlights turn off within 60 seconds after remote start shutdown?
<input type="checkbox"/>	YES: Go to next step.
<input type="checkbox"/>	NO: Verify the RAP SHUTDOWN connections as illustrated in the wiring diagram. Repeat the test and call technical support if the problem persists.
11	Open hood.
12	If not already installed, affix the mandatory orange warning sticker under the hood and proceed to next step.
13	Press the START/STOP button once [1x] on the aftermarket keyfob to remote start vehicle.
	Question 9: Does the vehicle remote start?
<input type="checkbox"/>	YES: The vehicle is not equipped with a factory hood pin. Install a mandatory aftermarket hood switch, then repeat the test.
<input type="checkbox"/>	NO: Go to next step.
14	Close hood.
15	Enter vehicle and close the doors.
16	Press the START/STOP button once [1x] on the aftermarket keyfob to remote start vehicle.
17	Wait for the vehicle to start.
18	Press brake pedal.
	Question 10: Does the vehicle shut down?
<input type="checkbox"/>	YES: Go to next step.
<input type="checkbox"/>	NO: The module does NOT detect the brake pedal signal. Press the START/STOP button once [1x] on the aftermarket keyfob to shut down vehicle, check connection as illustrated in the wiring diagram, if applicable, and call technical support.
19	Exit vehicle.
20	Installation checklist completed.

CHECKLIST - WITH OEM KEYFOB

1	WARNING: Vehicle engine will start many times. Test in a well ventilated area.
2	Close all vehicle doors, hood and trunk.
3	Press LOCK button three times [3x] rapidly on the OEM keyfob to remote start vehicle.
	Question 1: Does the vehicle remote start?
<input type="checkbox"/>	YES: Go to next step.
<input type="checkbox"/>	NO: The module doesn't detect OEM remote lock button from the vehicle communication network. Check all connections, repeat the test and call technical support, if the problem persists.
4	Press LOCK button three times [3x] rapidly on the OEM keyfob to shut down vehicle.
	Question 2: Does the vehicle shut down?
<input type="checkbox"/>	YES: Go to next step.
<input type="checkbox"/>	NO: Repeat step. If the problem persists, press on the brake pedal once [1x] to shut down the vehicle and call technical support.
5	RAP Shutdown test
	Question 3: Did the radio, interior controls, and headlights turn off within 60 seconds after remote start shutdown?
<input type="checkbox"/>	YES: Go to next step.
<input type="checkbox"/>	NO: Verify the RAP SHUTDOWN connections as illustrated in the wiring diagram. Repeat the test and call technical support, if the problem persists.
6	Open hood.
7	If not already installed, affix the mandatory orange warning sticker under the hood and proceed to next step.
8	Press LOCK button three times [3x] rapidly on the OEM keyfob to remote start vehicle.
	Question 4: Does the vehicle remote start?
<input type="checkbox"/>	YES: The vehicle is not equipped with a factory hood pin. Install a mandatory aftermarket hood switch, then repeat the test.
<input type="checkbox"/>	NO: Go to next step.
9	Close hood.
10	Enter vehicle and close the doors.
11	Press LOCK button three times [3x] rapidly on the OEM keyfob to remote start vehicle.
12	Wait for the vehicle to start.
13	Press brake pedal.
	Question 5: Does the vehicle shut down?
<input type="checkbox"/>	YES: Go to next step.
<input type="checkbox"/>	NO: The module does NOT detect the brake pedal signal. Press LOCK button three times [3x] rapidly on the OEM keyfob to shut down, check the brake connection as illustrated in the wiring diagram, if applicable, and call technical support.
14	Exit vehicle.
15	Installation checklist completed.



INSTALL GUIDE

2014-2018 MAZDA 3 SEDAN PTS AT

DOCUMENT NUMBER

REVISION DATE

20180829

FIRMWARE

ADS-RSA-MA3-[HCX000A]

HARDWARE

HCX000A

ACCESSORIES

ATTENTION: TO COMPLETE THIS INSTALLATION SOME ACCESSORIES MAY BE REQUIRED. VISIT OUR WEBSITE TO SEE ALL THE REQUIRED ACCESSORIES FOR YOUR VEHICLE.

TERMS OF USE

Automotive Data Solutions Inc. ("ADS") products are strictly intended for installation by Certified Technicians who are employed by a registered business specialized in the installation of automotive aftermarket electronics products. Prior to beginning installation of an ADS product in a vehicle, it is the Certified Technician's responsibility to review the most current Product Guide, Install Guide and vehicle-specific notes available in Weblink®. ADS is not responsible for any damages whatsoever, including but not limited to any consequential damages, incidental damages, damages for loss of time, loss of earnings, loss of profit, commercial loss, loss of economic opportunity and the like that may or may not have resulted from the use, misuse, improper installation or operation of its products. ADS reserves itself the right to suspend any Weblink® account without notice and decline to offer technical support to non-Certified Technicians, non-compliant Certified Technicians or end users.



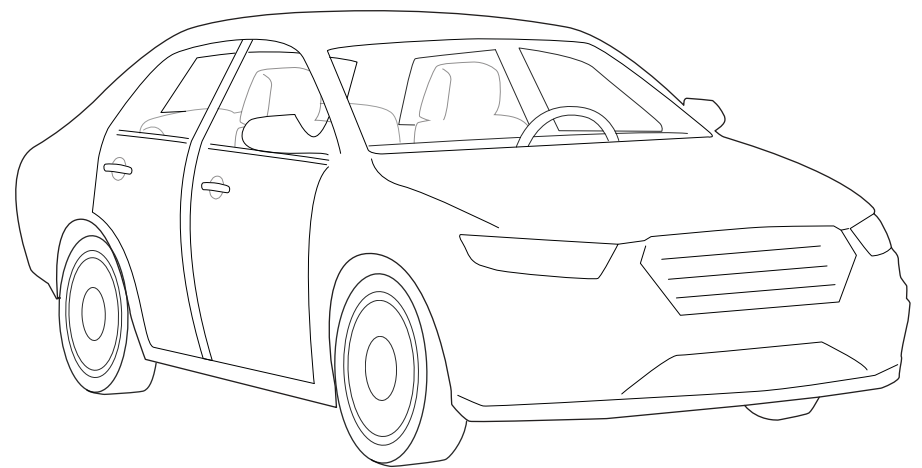
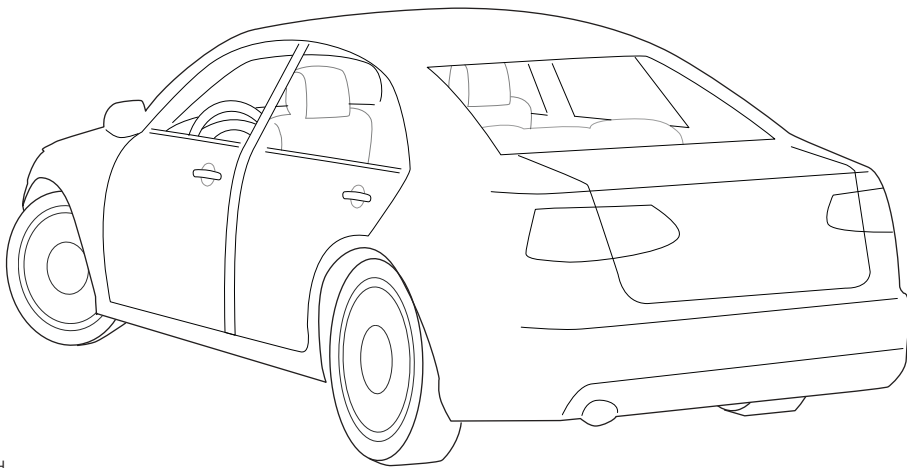
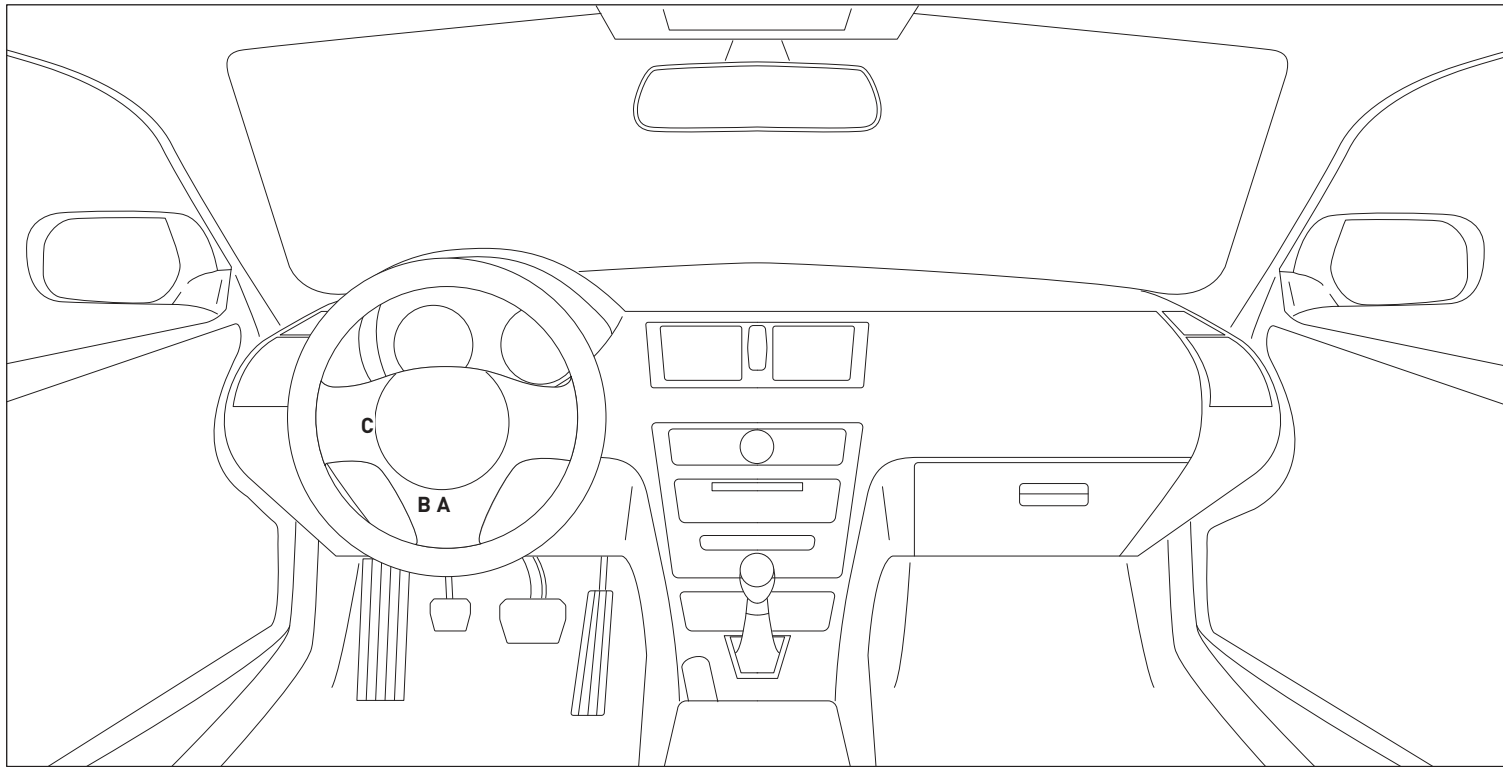

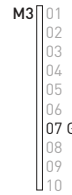
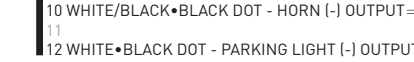
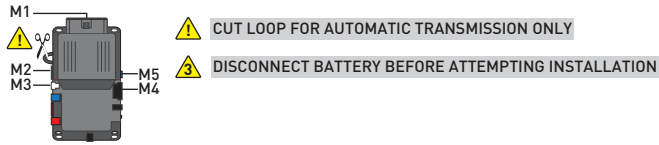

MS1



MS2

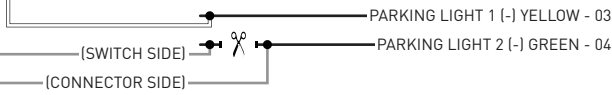
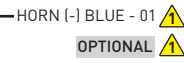
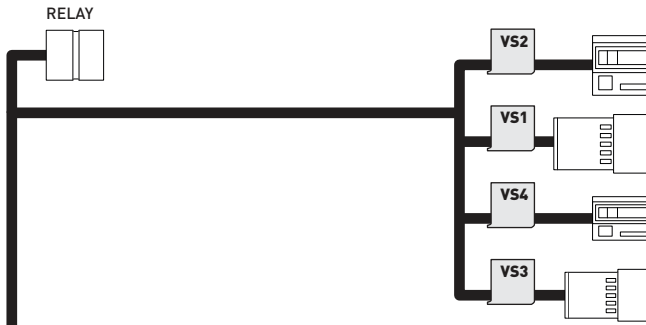

⚠ INSTALL THE SUPPLIED HOOD SWITCH IF THE VEHICLE IS NOT EQUIPPED WITH ONE
⚠ SET THE PROGRAMMING OPTION THROUGH WEBLINK AS FOLLOWS:
 IN "MENU #7 INPUTS CONFIGURATION",
 FOR "4-HOOD INPUT SOURCE" SELECT "1-ANALOG".

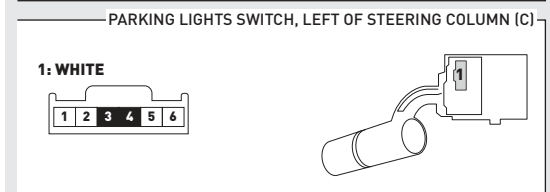
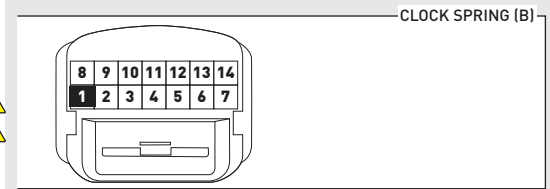
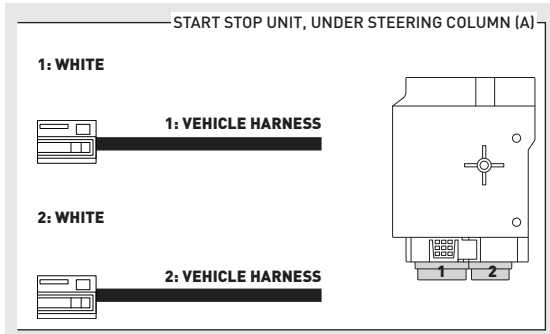

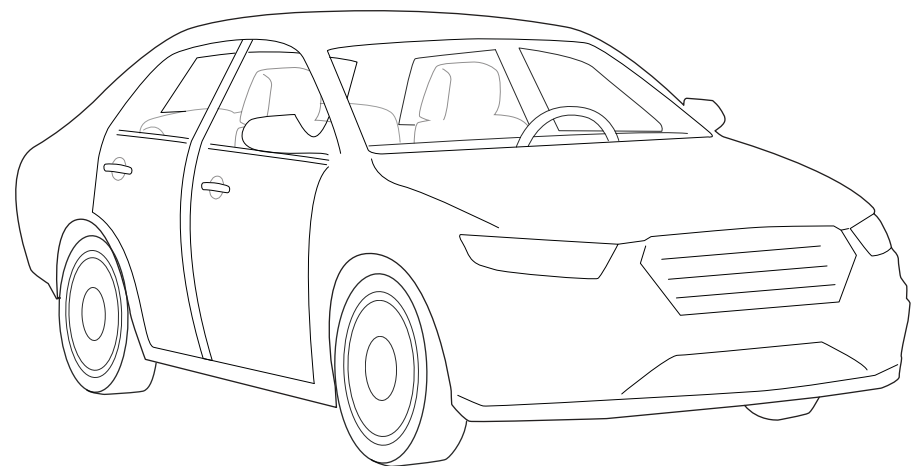
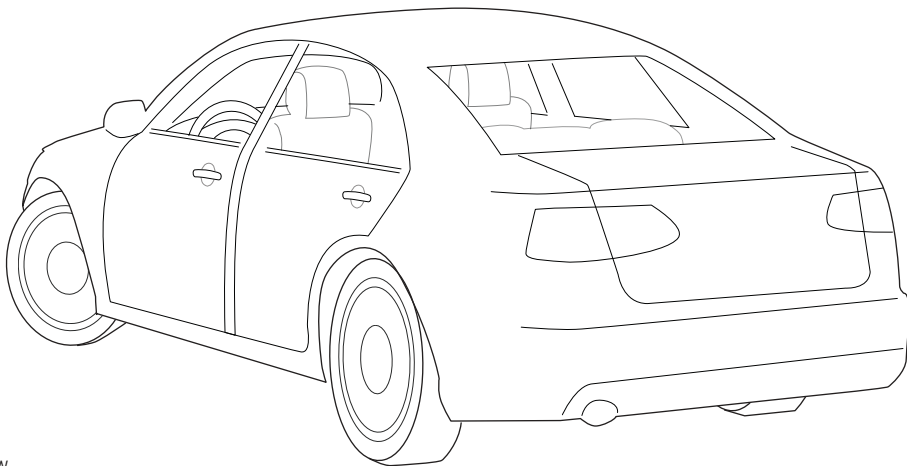
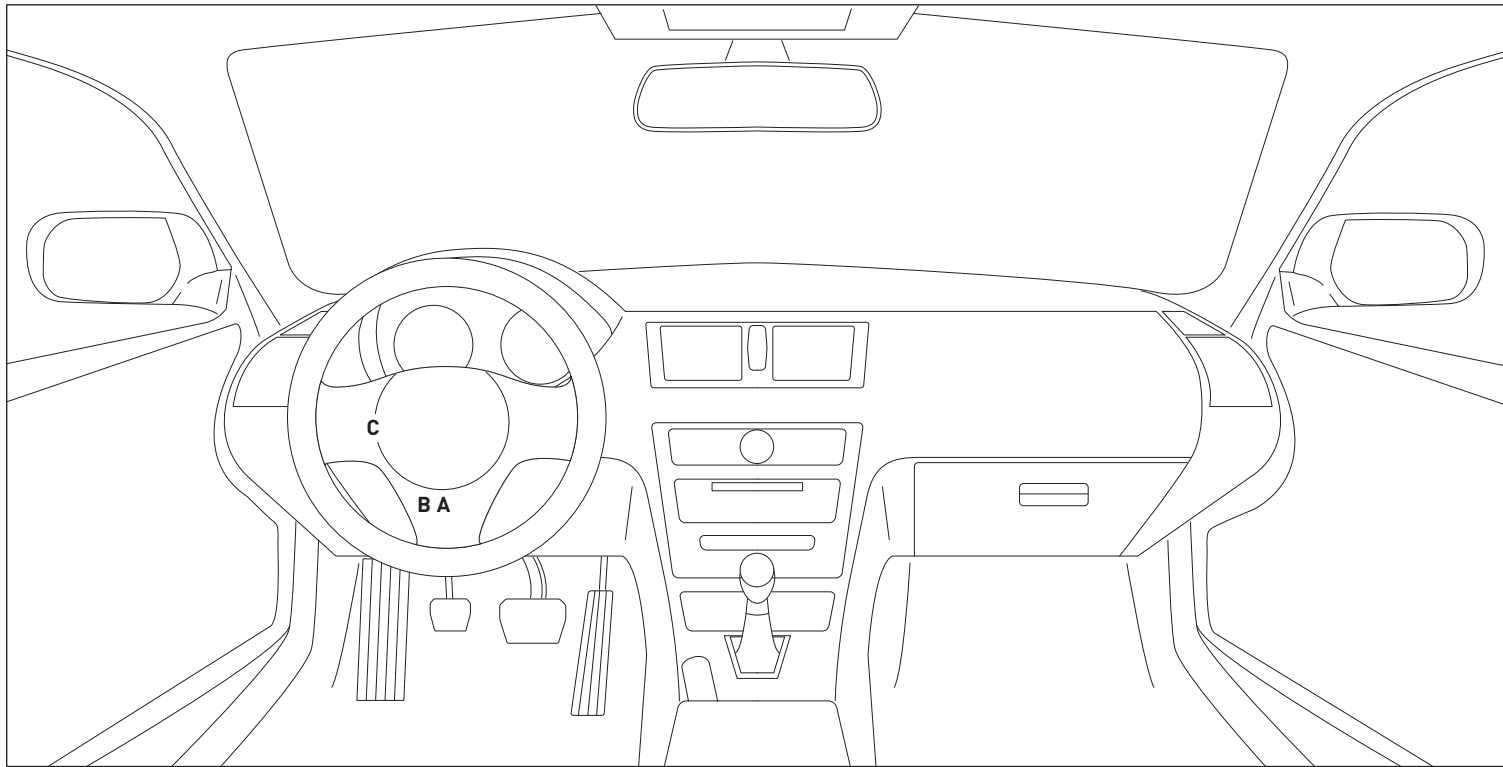

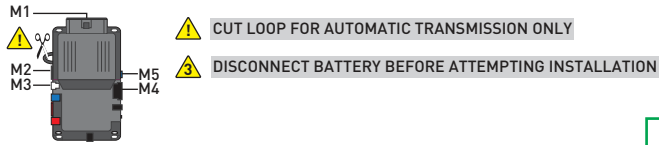

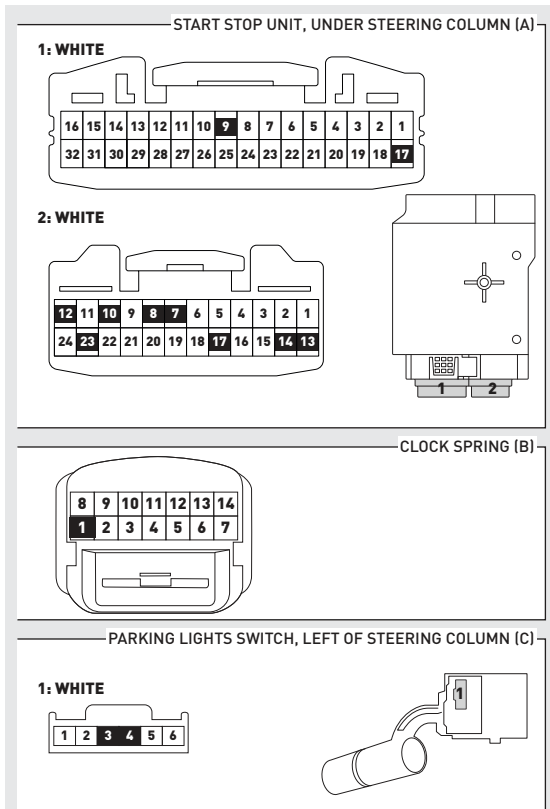
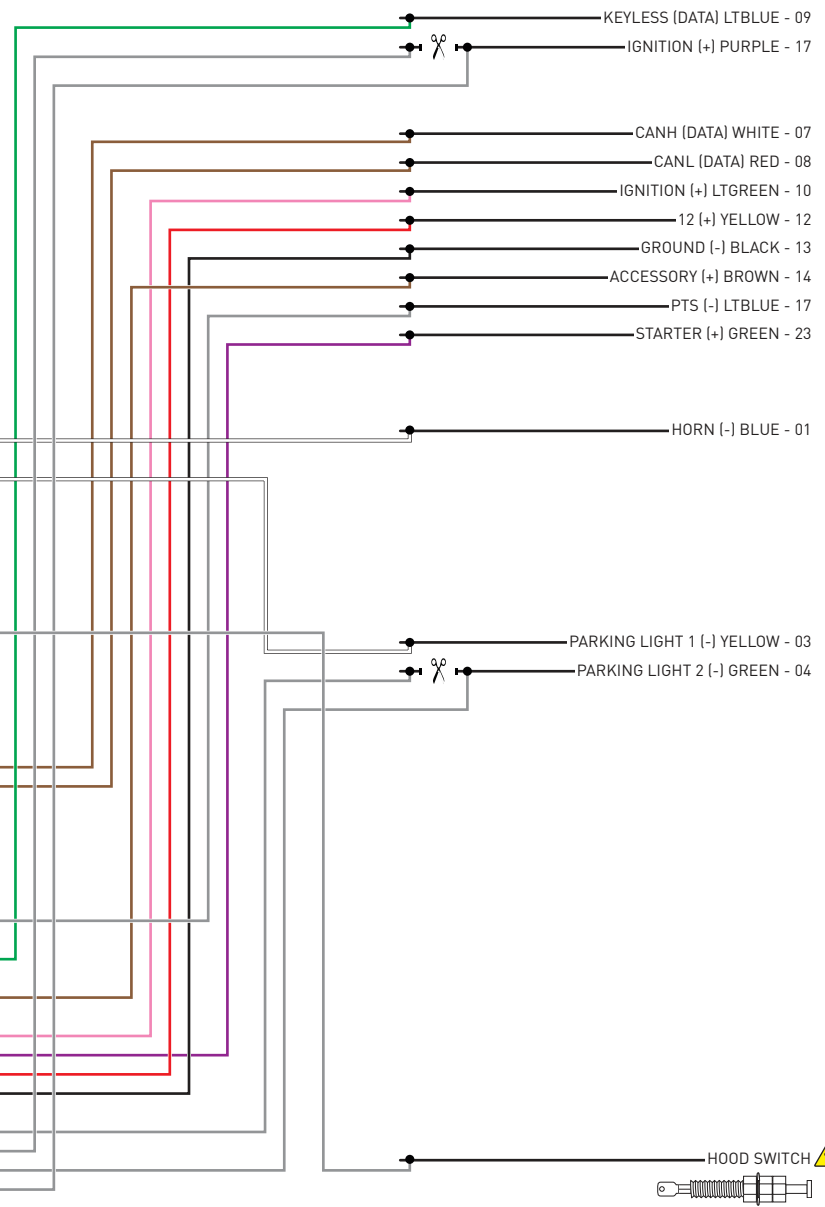

⚠ CUT LOOP FOR AUTOMATIC TRANSMISSION ONLY
⚠ DISCONNECT BATTERY BEFORE ATTEMPTING INSTALLATION

- M1**
 - 01 ORANGE
 - 02 RED
 - 03 PURPLE
 - 04 PINK/WHITE
 - 05 PINK
 - 06 WHITE
 - 07 RED
 - 08 BLACK
- M2**
 - 01 GREEN•BLACK DOT
 - 02 BLUE•BLACK DOT
 - 03 RED/WHITE•BLACK DOT
 - 04 GREEN/WHITE•BLACK DOT
 - 05 GREEN/BLACK•BLACK DOT
 - 06 BLUE/WHITE•BLACK DOT
 - 07 EMPTY
 - 08 WHITE/PURPLE•BLACK DOT
 - 09 PURPLE/BLACK•BLACK DOT
 - 10 WHITE/BLACK•BLACK DOT - HORN (-) OUTPUT
 - 11 BROWN/BLACK•BLACK DOT
 - 12 WHITE•BLACK DOT - PARKING LIGHT 1 (-) OUTPUT
- M3**
 - 01 BROWN•SILVER DOT
 - 02 BLACK/WHITE•SILVER DOT
 - 03 PURPLE•SILVER DOT
 - 04 GREEN•SILVER DOT
 - 05 PURPLE/WHITE•SILVER DOT
 - 06 WHITE/BLUE•SILVER DOT
 - 07 GRAY•SILVER DOT - HOOD STATUS (-) INPUT
 - 08 BLUE•SILVER DOT
 - 09 GRAY/BLACK•SILVER DOT
 - 10 EMPTY
- M4**
 - 01 EMPTY
 - 02 EMPTY
 - 03 BROWN/RED - CANH 1
 - 04 BROWN/YELLOW - CANL 1
 - 05 BLUE/RED
 - 06 BLUE/YELLOW
 - 07 EMPTY
 - 08 ORANGE
 - 09 YELLOW
 - 10 EMPTY
 - 11 GRAY/RED - PTS (-) OUTPUT
 - 12 GRAY/YELLOW
 - 13 GREEN/RED - KEYLESS (DATA)
 - 14 ORANGE/WHITE
 - 15 BROWN - ACCESSORY (+) IN/OUT
 - 16 ORANGE/BLACK
 - 17 PINK - IGNITION (+) IN/OUT
 - 18 PURPLE - STARTER (+) OUTPUT
 - 19 RED - 12V (+) INPUT
 - 20 BLACK - GROUND (-)
- M5**
 - 01 GRAY/BLACK•BLUE DOT - PARKING LIGHT 2 (-) SWITCH SIDE
 - 02 WHITE/BLACK•BLUE DOT - IGNITION (+)
 - 03 GRAY/RED•BLUE DOT - PARKING LIGHT 2 (-) CONNECTOR SIDE
 - 04 WHITE/RED•BLUE DOT - IGNITION (+)
 - 05 GRAY•BLUE DOT
 - 06 WHITE•BLUE DOT





⚠ INSTALL THE SUPPLIED HOOD SWITCH IF THE VEHICLE IS NOT EQUIPPED WITH ONE SET THE PROGRAMMING OPTION THROUGH WEBLINK AS FOLLOWS: IN "MENU #7 INPUTS CONFIGURATION", FOR "4-HOOD INPUT SOURCE" SELECT "1-ANALOG".

>>  WARNING: All vehicle doors must be closed and locked prior to remote start sequence.

01  Set ignition to ON position.

02  Wait, LED 1 will turn solid RED to confirm that the ignition is ON.

03  Wait 10 seconds, LED 1 will flash GREEN rapidly.

04  Set ignition to OFF position.

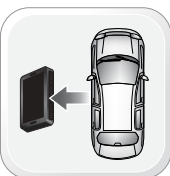
05  WARNING: Disconnect power last. Disconnect module from vehicle.

06  Connect module to computer and proceed with extended programming.

07  Connect power first. Connect module to vehicle.

08  Set ignition to ON position.

09  Wait, LED 1 will turn solid RED to confirm that the ignition is ON.

10  Wait, LED 1 will turn solid GREEN for 2 seconds.

11  Set ignition to OFF position.

>>  If vehicle is equipped with power liftgate: open and close the power liftgate with OEM keyfob.

12  START vehicle for 15 seconds.

13  Press and hold the brake pedal.

14  Press and release the module's programming button.

15  Release the brake pedal.

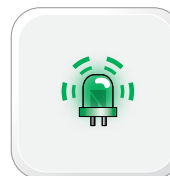
16  Wait, LED 2 will flash GREEN. Module Programming Procedure completed.

>>



All vehicle doors must be closed and locked prior to remote start sequence.

01



Time restriction. Complete steps 2 to 5 within 45 seconds.

02



Press unlock on OEM or aftermarket remote or request switch.

03



Open driver door and enter vehicle.

04



Close driver door.

05



Press and release BRAKE pedal.

06



Take over procedure completed.

>>



Failure to follow procedure will result in vehicle engine shutdown.

CHECKLIST - WITH AFTERMARKET KEYFOB

1	WARNING: Vehicle engine will start many times. Test in a well ventilated area.	9	Press the START/STOP button once [1x] on the aftermarket keyfob to shut down vehicle.
2	Close all vehicle doors, hood and trunk.		Question 7: Does the vehicle shut down?
3	Press the LOCK button once [1x] on the aftermarket keyfob.	<input type="checkbox"/>	YES: Go to next step.
	Question 1: Do the doors lock?	<input type="checkbox"/>	NO: Repeat step. If problem persists, press the brake pedal once [1x] to shut down the vehicle and call technical support.
<input type="checkbox"/>	YES: Go to next step.	10	RAP and auto light shutdown test
<input type="checkbox"/>	NO: Verify the remote programming, the RF connections and the wired door lock/unlock connections as illustrated in the wiring diagram, if applicable. Repeat the test and call technical support, if the problem persists.		Question 8: Did the radio, interior controls and headlights turn off within 60 seconds after remote start shutdown?
4	Press the UNLOCK button once [1x] on the aftermarket keyfob.	<input type="checkbox"/>	YES: Go to next step.
	Question 2: Do the doors unlock?	<input type="checkbox"/>	NO: Verify the RAP SHUTDOWN connections as illustrated in the wiring diagram. Repeat the test and call technical support if the problem persists.
<input type="checkbox"/>	YES: Go to next step.	11	Open hood.
<input type="checkbox"/>	NO: Verify the remote programming, the RF connections and the wired door lock/unlock connections as illustrated in the wiring diagram, if applicable. Repeat the test and call technical support, if the problem persists.	12	If not already installed, affix the mandatory orange warning sticker under the hood and proceed to next step.
5	Press the TRUNK release button once [1x] on the aftermarket keyfob if supported.	13	Press the START/STOP button once [1x] on the aftermarket keyfob to remote start vehicle.
	Question 3: Does the trunk or hatch open/unlock?		Question 9: Does the vehicle remote start?
<input type="checkbox"/>	YES: Close trunk or hatch and go to next step.	<input type="checkbox"/>	YES: The vehicle is not equipped with a factory hood pin. Install a mandatory aftermarket hood switch, then repeat the test.
<input type="checkbox"/>	NO: Verify the remote programming, the RF connections and the wired trunk/hatch connections as illustrated in the wiring diagram, if applicable. Repeat the test and call technical support, if the problem persists.	<input type="checkbox"/>	NO: Go to next step.
6	Press the AUX 1 button once [1x] on the aftermarket keyfob if supported.	14	Close hood.
	Question 4: Does the driver side sliding door open?	15	Enter vehicle and close the doors.
<input type="checkbox"/>	YES: Press the AUX 1 button once [1x] to close the driver sliding door and go to next step.	16	Press the START/STOP button once [1x] on the aftermarket keyfob to remote start vehicle.
<input type="checkbox"/>	NO: Verify the remote programming and the RF connections. Repeat the test and call technical support, if the problem persists.	17	Wait for the vehicle to start.
7	Press the AUX 2 button once [1x] on the aftermarket keyfob if supported.	18	Press brake pedal.
	Question 5: Does the passenger side sliding door open?		Question 10: Does the vehicle shut down?
<input type="checkbox"/>	YES: Press the AUX 2 button once [1x] to close the passenger sliding door and go to next step.	<input type="checkbox"/>	YES: Go to next step.
<input type="checkbox"/>	NO: Verify the remote programming and the RF connections. Repeat the test and call technical support, if the problem persists.	<input type="checkbox"/>	NO: The module does NOT detect the brake pedal signal. Press the START/STOP button once [1x] on the aftermarket keyfob to shut down vehicle, check connection as illustrated in the wiring diagram, if applicable, and call technical support.
8	Press the START/STOP button once [1x] on the aftermarket keyfob to remote start vehicle.	19	Exit vehicle.
	Question 6: Does the vehicle remote start?	20	Installation checklist completed.
<input type="checkbox"/>	YES: Go to next step.		
<input type="checkbox"/>	NO: Verify the remote programming, the RF connections and check the remote start error codes. Repeat the test and call technical support, if the problem persists.		

CHECKLIST - WITH OEM KEYFOB

1	WARNING: Vehicle engine will start many times. Test in a well ventilated area.
2	Close all vehicle doors, hood and trunk.
3	Press LOCK button three times [3x] rapidly on the OEM keyfob to remote start vehicle.
	Question 1: Does the vehicle remote start?
<input type="checkbox"/>	YES: Go to next step.
<input type="checkbox"/>	NO: The module doesn't detect OEM remote lock button from the vehicle communication network. Check all connections, repeat the test and call technical support, if the problem persists.
4	Press LOCK button three times [3x] rapidly on the OEM keyfob to shut down vehicle.
	Question 2: Does the vehicle shut down?
<input type="checkbox"/>	YES: Go to next step.
<input type="checkbox"/>	NO: Repeat step. If the problem persists, press on the brake pedal once [1x] to shut down the vehicle and call technical support.
5	RAP Shutdown test
	Question 3: Did the radio, interior controls, and headlights turn off within 60 seconds after remote start shutdown?
<input type="checkbox"/>	YES: Go to next step.
<input type="checkbox"/>	NO: Verify the RAP SHUTDOWN connections as illustrated in the wiring diagram. Repeat the test and call technical support, if the problem persists.
6	Open hood.
7	If not already installed, affix the mandatory orange warning sticker under the hood and proceed to next step.
8	Press LOCK button three times [3x] rapidly on the OEM keyfob to remote start vehicle.
	Question 4: Does the vehicle remote start?
<input type="checkbox"/>	YES: The vehicle is not equipped with a factory hood pin. Install a mandatory aftermarket hood switch, then repeat the test.
<input type="checkbox"/>	NO: Go to next step.
9	Close hood.
10	Enter vehicle and close the doors.
11	Press LOCK button three times [3x] rapidly on the OEM keyfob to remote start vehicle.
12	Wait for the vehicle to start.
13	Press brake pedal.
	Question 5: Does the vehicle shut down?
<input type="checkbox"/>	YES: Go to next step.
<input type="checkbox"/>	NO: The module does NOT detect the brake pedal signal. Press LOCK button three times [3x] rapidly on the OEM keyfob to shut down, check the brake connection as illustrated in the wiring diagram, if applicable, and call technical support.
14	Exit vehicle.
15	Installation checklist completed.



INSTALL GUIDE

2014-2018 MAZDA 3 HATCHBACK PTS MT

DOCUMENT NUMBER

REVISION DATE

20180829

FIRMWARE

ADS-RSA-MA3-[HCX000A]

HARDWARE

HCX000A

ACCESSORIES

ATTENTION: TO COMPLETE THIS INSTALLATION SOME ACCESSORIES MAY BE REQUIRED. VISIT OUR WEBSITE TO SEE ALL THE REQUIRED ACCESSORIES FOR YOUR VEHICLE.

TERMS OF USE

Automotive Data Solutions Inc. ("ADS") products are strictly intended for installation by Certified Technicians who are employed by a registered business specialized in the installation of automotive aftermarket electronics products. Prior to beginning installation of an ADS product in a vehicle, it is the Certified Technician's responsibility to review the most current Product Guide, Install Guide and vehicle-specific notes available in Weblink®. ADS is not responsible for any damages whatsoever, including but not limited to any consequential damages, incidental damages, damages for loss of time, loss of earnings, loss of profit, commercial loss, loss of economic opportunity and the like that may or may not have resulted from the use, misuse, improper installation or operation of its products. ADS reserves itself the right to suspend any Weblink® account without notice and decline to offer technical support to non-Certified Technicians, non-compliant Certified Technicians or end users.



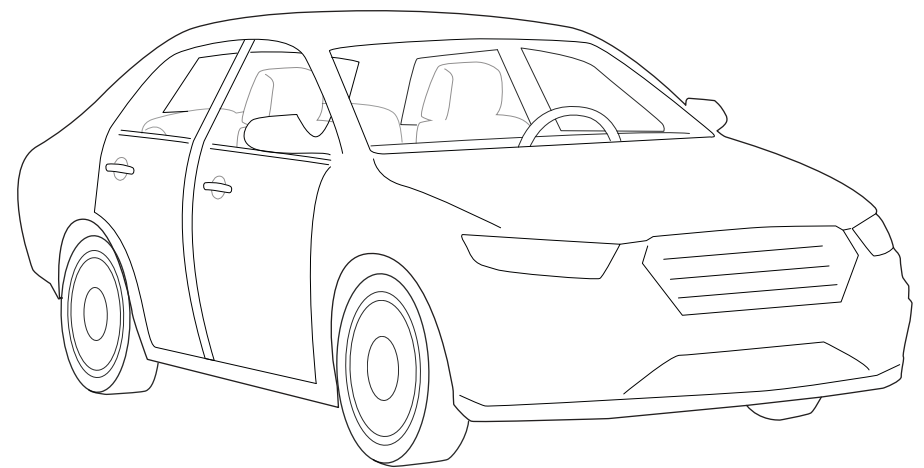
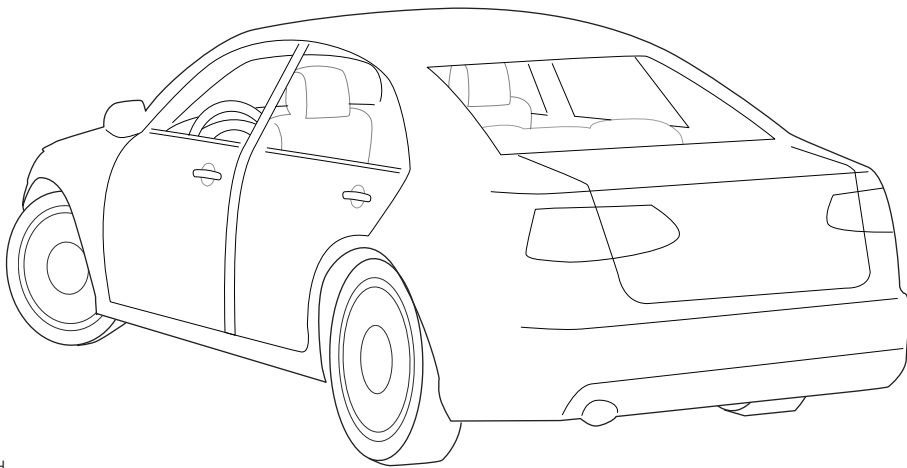
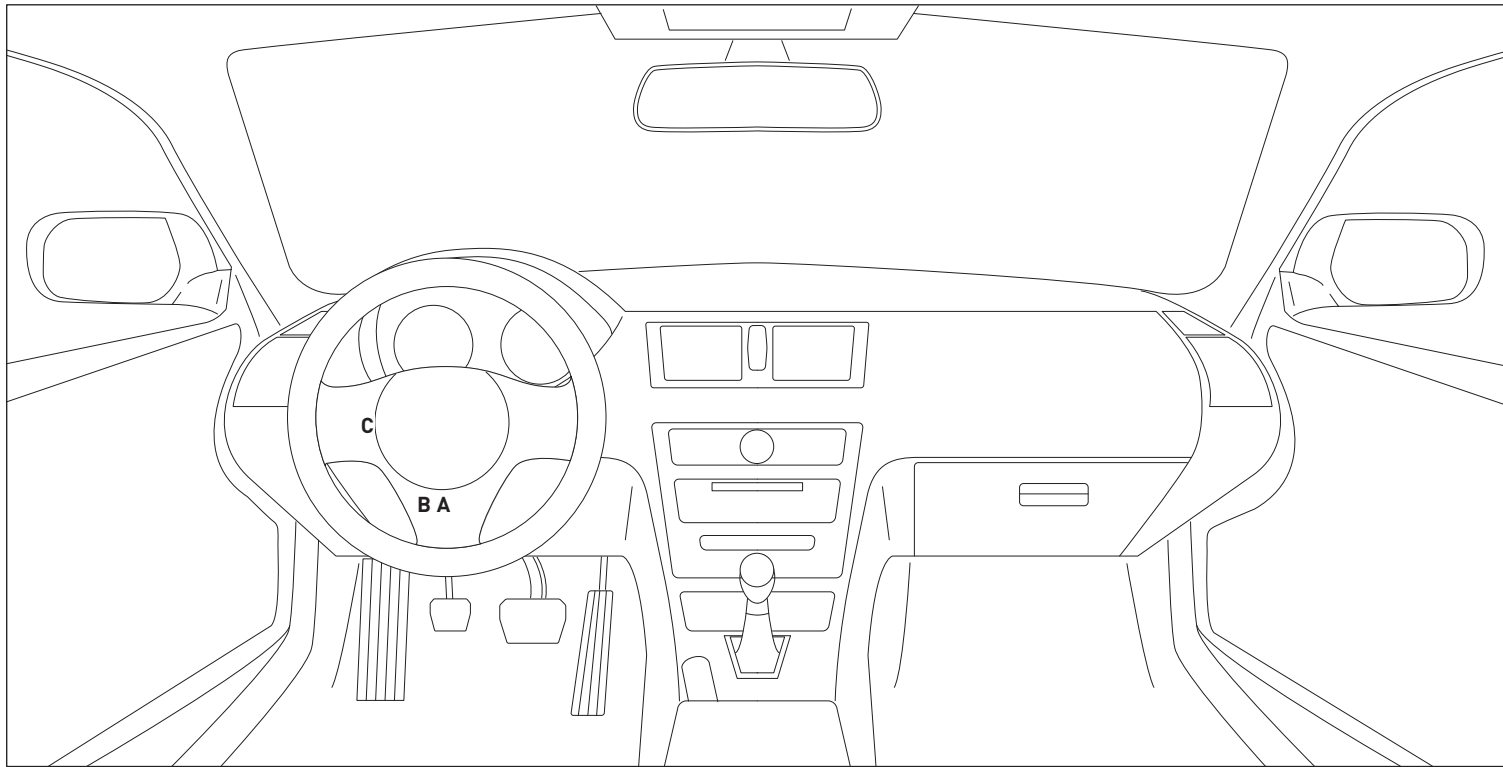

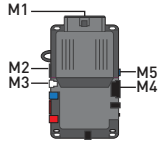

MANDATORY STEPS FOR MANUAL TRANSMISSION:
 1- DO NOT CUT THE LOOP.
 2- CONNECT THE MANUAL TRANSMISSION DIGITAL SENSOR.
 3- SEE THE PRODUCT GUIDE FOR MORE INFORMATION.

DISCONNECT BATTERY BEFORE ATTEMPTING INSTALLATION

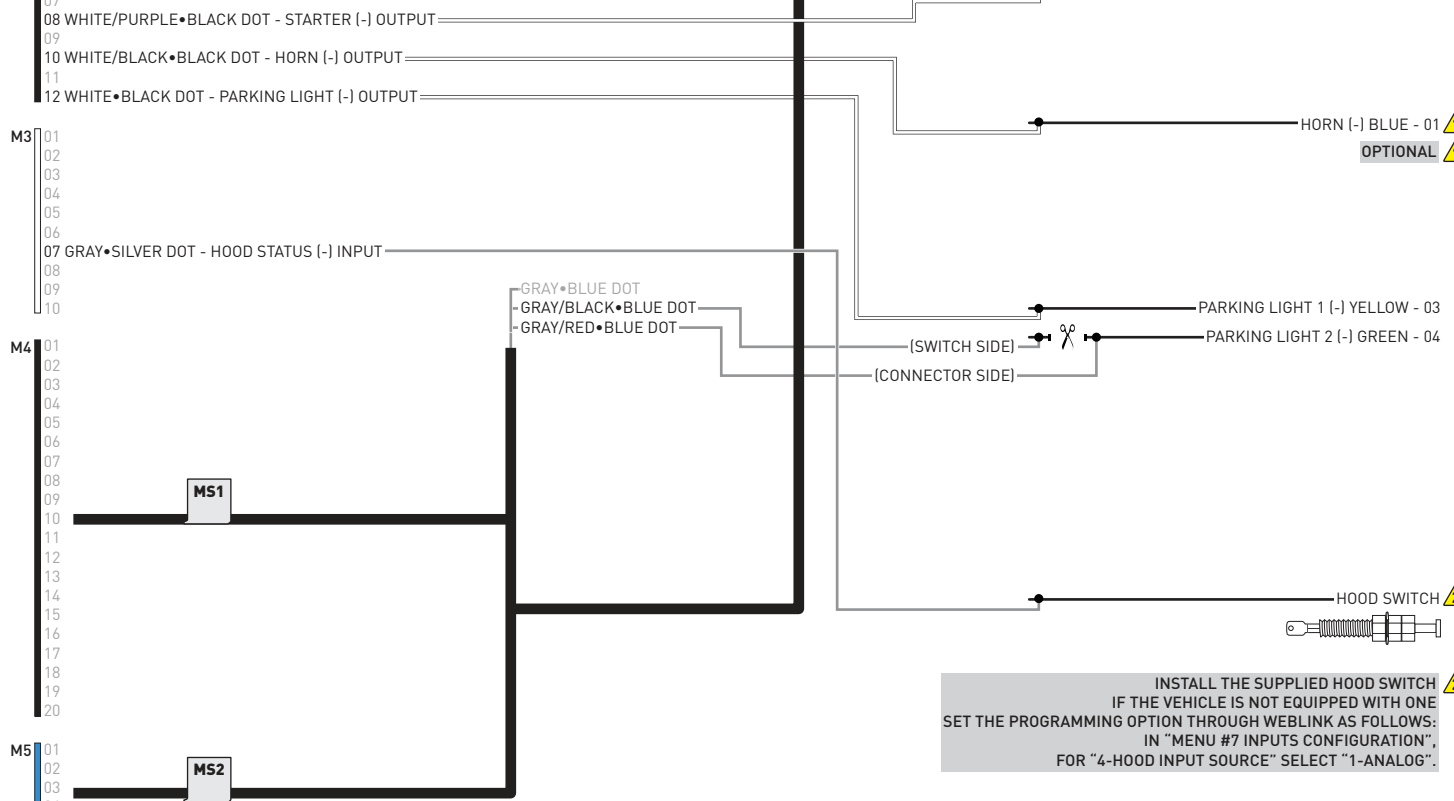
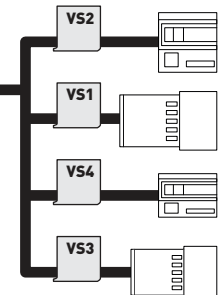
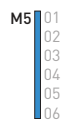
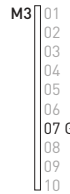

INSTALL THE SUPPLIED HOOD SWITCH IF THE VEHICLE IS NOT EQUIPPED WITH ONE SET THE PROGRAMMING OPTION THROUGH WEBLINK AS FOLLOWS: IN "MENU #7 INPUTS CONFIGURATION", FOR "4-HOOD INPUT SOURCE" SELECT "1-ANALOG".

START STOP UNIT, UNDER STEERING COLUMN (A)

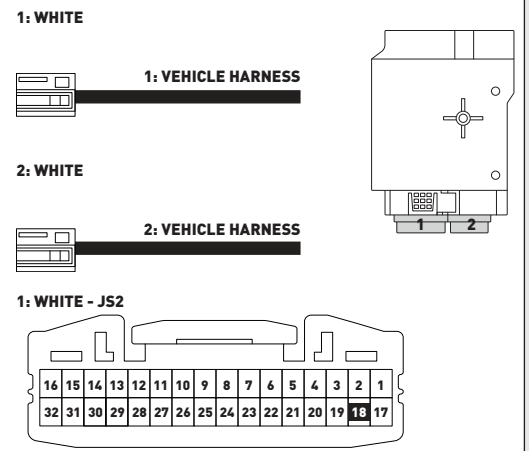

CLOCK SPRING (B)

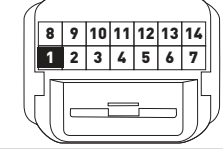

PARKING LIGHTS SWITCH, LEFT OF STEERING COLUMN (C)

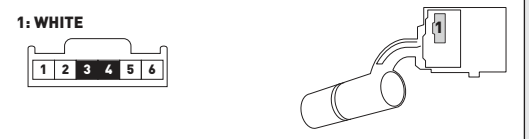

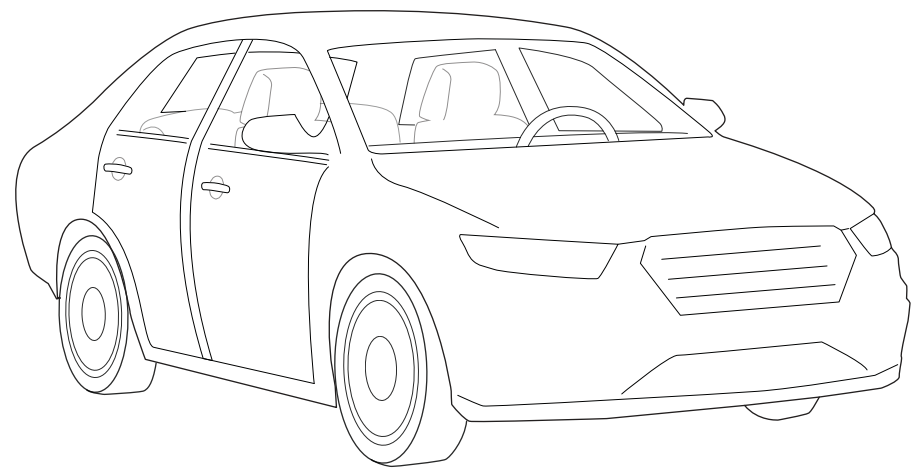
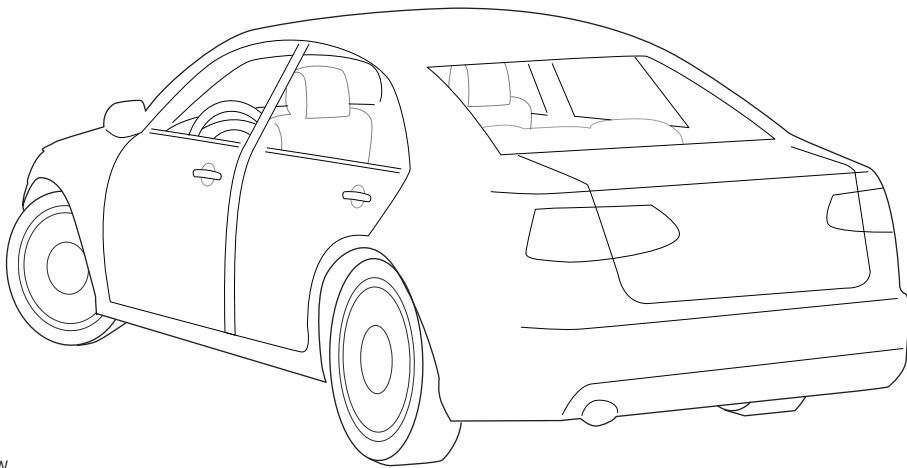
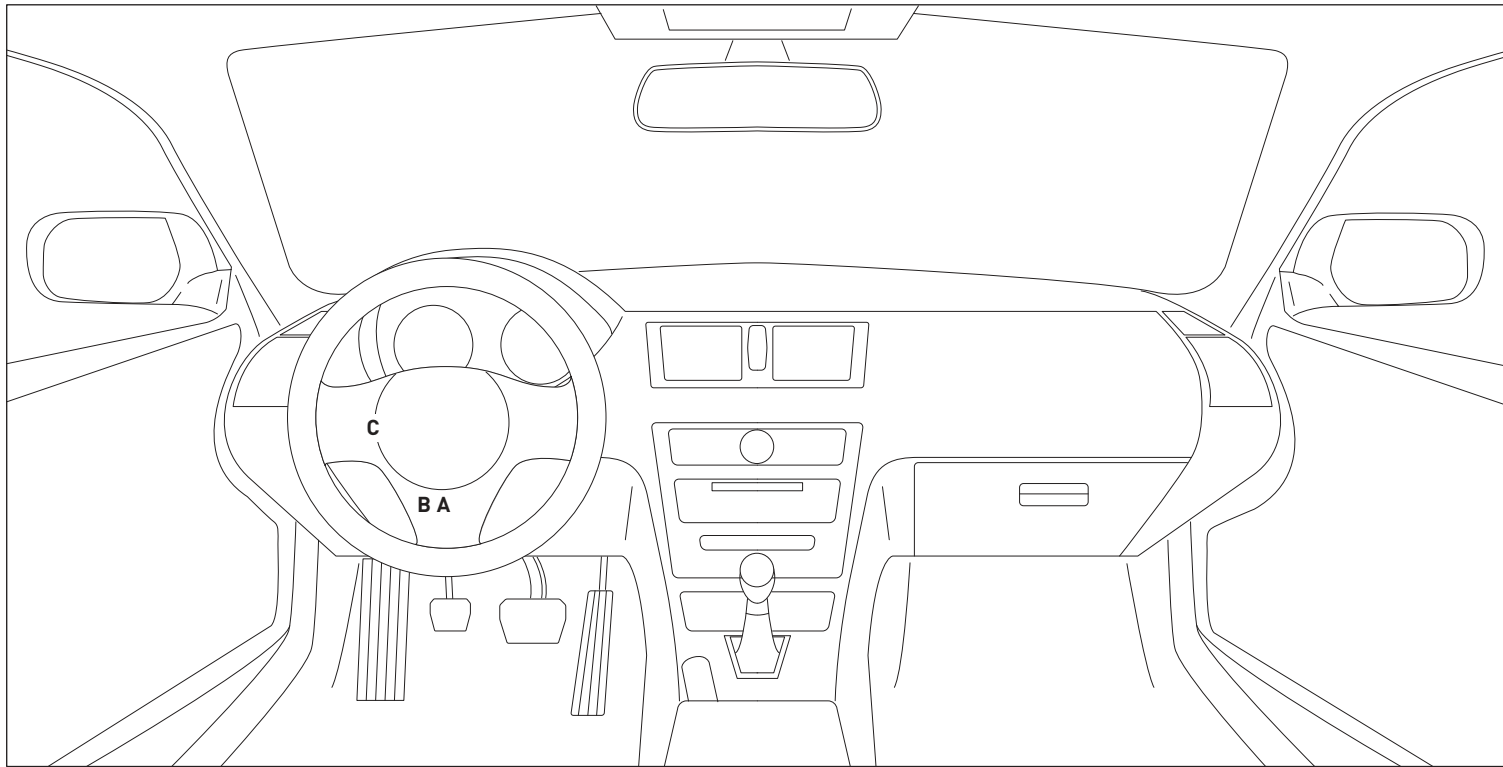

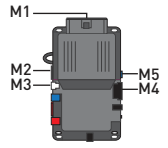

MANDATORY STEPS FOR MANUAL TRANSMISSION:
 1- DO NOT CUT THE LOOP.
 2- CONNECT THE MANUAL TRANSMISSION DIGITAL SENSOR.
 3- SEE THE PRODUCT GUIDE FOR MORE INFORMATION.

DISCONNECT BATTERY BEFORE ATTEMPTING INSTALLATION

- M1**
 - 01 ORANGE
 - 02 RED
 - 03 PURPLE
 - 04 PINK/WHITE
 - 05 PINK
 - 06 WHITE
 - 07 RED
 - 08 BLACK
- M2**
 - 01 GREEN•BLACK DOT
 - 02 BLUE•BLACK DOT
 - 03 RED/WHITE•BLACK DOT
 - 04 GREEN/WHITE•BLACK DOT
 - 05 GREEN/BLACK•BLACK DOT
 - 06 BLUE/WHITE•BLACK DOT
 - 07 EMPTY
 - 08 WHITE/PURPLE•BLACK DOT - STARTER (-) OUTPUT
 - 09 PURPLE/BLACK•BLACK DOT
 - 10 WHITE/BLACK•BLACK DOT - HORN (-) OUTPUT
 - 11 BROWN/BLACK•BLACK DOT
 - 12 WHITE•BLACK DOT - PARKING LIGHT 1 (-) OUTPUT
- M3**
 - 01 BROWN•SILVER DOT
 - 02 BLACK/WHITE•SILVER DOT
 - 03 PURPLE•SILVER DOT
 - 04 GREEN•SILVER DOT
 - 05 PURPLE/WHITE•SILVER DOT
 - 06 WHITE/BLUE•SILVER DOT
 - 07 GRAY•SILVER DOT - HOOD STATUS (-) INPUT
 - 08 BLUE•SILVER DOT
 - 09 GRAY/BLACK•SILVER DOT
 - 10 EMPTY
- M4**
 - 01 EMPTY
 - 02 EMPTY
 - 03 BROWN/RED - CANH 1
 - 04 BROWN/YELLOW - CANL 1
 - 05 BLUE/RED
 - 06 BLUE/YELLOW
 - 07 EMPTY
 - 08 ORANGE
 - 09 YELLOW
 - 10 EMPTY
 - 11 GRAY/RED - PTS (-) OUTPUT
 - 12 GRAY/YELLOW
 - 13 GREEN/RED - KEYLESS (DATA)
 - 14 ORANGE/WHITE
 - 15 BROWN - ACCESSORY (+) IN/OUT
 - 16 ORANGE/BLACK
 - 17 PINK - IGNITION (+) IN/OUT
 - 18 PURPLE - STARTER (+) OUTPUT
 - 19 RED - 12V (+) INPUT
 - 20 BLACK - GROUND (-)
- M5**
 - 01 GRAY/BLACK•BLUE DOT - PARKING LIGHT 2 (-) SWITCH SIDE
 - 02 WHITE/BLACK•BLUE DOT - IGNITION (+) VEHICLE SIDE
 - 03 GRAY/RED•BLUE DOT - PARKING LIGHT 2 (-) CONNECTOR SIDE
 - 04 WHITE/RED•BLUE DOT - IGNITION (+) CONNECTOR SIDE
 - 05 GRAY•BLUE DOT
 - 06 WHITE•BLUE DOT

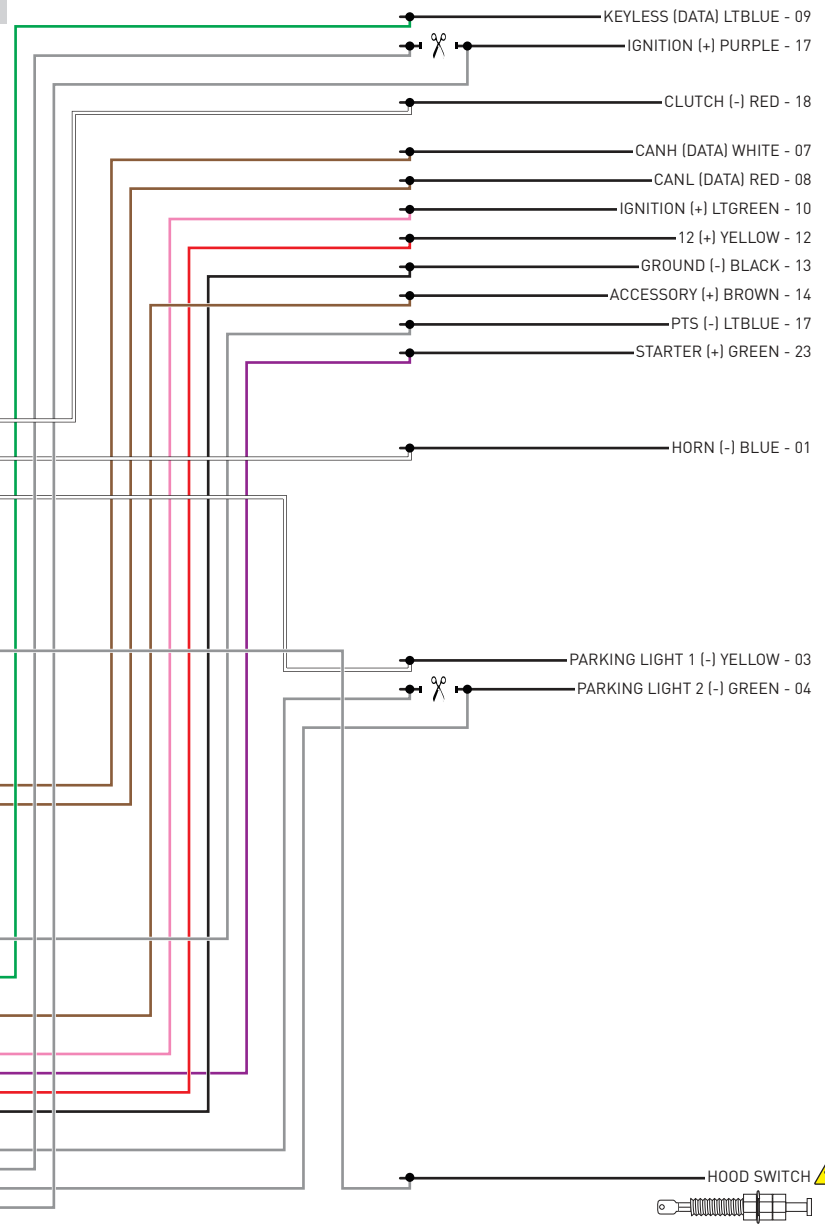

START STOP UNIT, UNDER STEERING COLUMN (A)

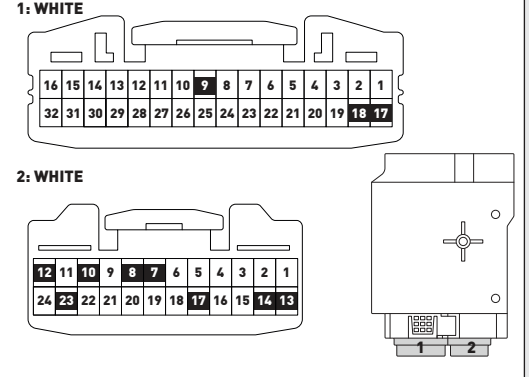

CLOCK SPRING (B)

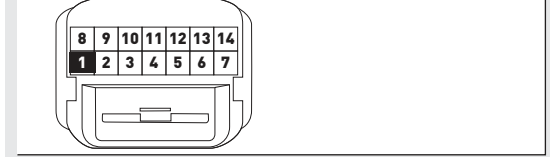

PARKING LIGHTS SWITCH, LEFT OF STEERING COLUMN (C)





INSTALL THE SUPPLIED HOOD SWITCH IF THE VEHICLE IS NOT EQUIPPED WITH ONE SET THE PROGRAMMING OPTION THROUGH WEBLINK AS FOLLOWS: IN "MENU #7 INPUTS CONFIGURATION", FOR "4-HOOD INPUT SOURCE" SELECT "1-ANALOG".

>>  WARNING: All vehicle doors must be closed and locked prior to remote start sequence.

01  Set ignition to ON position.

02  Wait, LED 1 will turn solid RED to confirm that the ignition is ON.

03  Wait 10 seconds, LED 1 will flash GREEN rapidly.

04  Set ignition to OFF position.

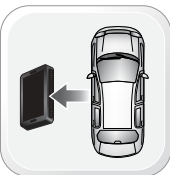
05  WARNING: Disconnect power last. Disconnect module from vehicle.

06  Connect module to computer and proceed with extended programming.

07  Connect power first. Connect module to vehicle.

08  Set ignition to ON position.

09  Wait, LED 1 will turn solid RED to confirm that the ignition is ON.

10  Wait, LED 1 will turn solid GREEN for 2 seconds.

11  Set ignition to OFF position.

>>  If vehicle is equipped with power liftgate: open and close the power liftgate with OEM keyfob.

12  START vehicle for 15 seconds.

13  Press and hold the brake pedal.

14  Press and release the module's programming button.

15  Release the brake pedal.

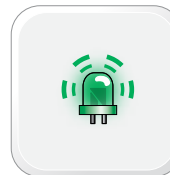
16  Wait, LED 2 will flash GREEN. Module Programming Procedure completed.

>>



All vehicle doors must be closed and locked prior to remote start sequence.

01



Time restriction. Complete steps 2 to 5 within 45 seconds.

02



Press unlock on OEM or aftermarket remote or request switch.

03



Open driver door and enter vehicle.

04



Close driver door.

05



Press and release BRAKE pedal.

06



Take over procedure completed.

>>



Failure to follow procedure will result in vehicle engine shutdown.

CHECKLIST - WITH AFTERMARKET KEYFOB

1	WARNING: Vehicle engine will start many times. Test in a well ventilated area.
2	Close all vehicle doors, hood and trunk.
3	Press the LOCK button once [1x] on the aftermarket keyfob.
	Question 1: Do the doors lock?
<input type="checkbox"/>	YES: Go to next step.
<input type="checkbox"/>	NO: Verify the remote programming, the RF connections and the wired door lock/unlock connections as illustrated in the wiring diagram, if applicable. Repeat the test and call technical support, if the problem persists.
4	Press the UNLOCK button once [1x] on the aftermarket keyfob.
	Question 2: Do the doors unlock?
<input type="checkbox"/>	YES: Go to next step.
<input type="checkbox"/>	NO: Verify the remote programming, the RF connections and the wired door lock/unlock connections as illustrated in the wiring diagram, if applicable. Repeat the test and call technical support, if the problem persists.
5	Press the TRUNK release button once [1x] on the aftermarket keyfob if supported.
	Question 3: Does the trunk or hatch open/unlock?
<input type="checkbox"/>	YES: Close trunk or hatch and go to next step.
<input type="checkbox"/>	NO: Verify the remote programming, the RF connections and the wired trunk/hatch connections as illustrated in the wiring diagram, if applicable. Repeat the test and call technical support, if the problem persists.
6	Press the AUX 1 button once [1x] on the aftermarket keyfob if supported.
	Question 4: Does the driver side sliding door open?
<input type="checkbox"/>	YES: Press the AUX 1 button once [1x] to close the driver sliding door and go to next step.
<input type="checkbox"/>	NO: Verify the remote programming and the RF connections. Repeat the test and call technical support, if the problem persists.
7	Press the AUX 2 button once [1x] on the aftermarket keyfob if supported.
	Question 5: Does the passenger side sliding door open?
<input type="checkbox"/>	YES: Press the AUX 2 button once [1x] to close the passenger sliding door and go to next step.
<input type="checkbox"/>	NO: Verify the remote programming and the RF connections. Repeat the test and call technical support, if the problem persists.
8	Press the START/STOP button once [1x] on the aftermarket keyfob to remote start vehicle.
	Question 6: Does the vehicle remote start?
<input type="checkbox"/>	YES: Go to next step.
<input type="checkbox"/>	NO: Verify the remote programming, the RF connections and check the remote start error codes. Repeat the test and call technical support, if the problem persists.

9	Press the START/STOP button once [1x] on the aftermarket keyfob to shut down vehicle.
	Question 7: Does the vehicle shut down?
<input type="checkbox"/>	YES: Go to next step.
<input type="checkbox"/>	NO: Repeat step. If problem persists, press the brake pedal once [1x] to shut down the vehicle and call technical support.
10	RAP and auto light shutdown test
	Question 8: Did the radio, interior controls and headlights turn off within 60 seconds after remote start shutdown?
<input type="checkbox"/>	YES: Go to next step.
<input type="checkbox"/>	NO: Verify the RAP SHUTDOWN connections as illustrated in the wiring diagram. Repeat the test and call technical support if the problem persists.
11	Open hood.
12	If not already installed, affix the mandatory orange warning sticker under the hood and proceed to next step.
13	Press the START/STOP button once [1x] on the aftermarket keyfob to remote start vehicle.
	Question 9: Does the vehicle remote start?
<input type="checkbox"/>	YES: The vehicle is not equipped with a factory hood pin. Install a mandatory aftermarket hood switch, then repeat the test.
<input type="checkbox"/>	NO: Go to next step.
14	Close hood.
15	Enter vehicle and close the doors.
16	Press the START/STOP button once [1x] on the aftermarket keyfob to remote start vehicle.
17	Wait for the vehicle to start.
18	Press brake pedal.
	Question 10: Does the vehicle shut down?
<input type="checkbox"/>	YES: Go to next step.
<input type="checkbox"/>	NO: The module does NOT detect the brake pedal signal. Press the START/STOP button once [1x] on the aftermarket keyfob to shut down vehicle, check connection as illustrated in the wiring diagram, if applicable, and call technical support.
19	Exit vehicle.
20	Installation checklist completed.

CHECKLIST - WITH OEM KEYFOB

1	WARNING: Vehicle engine will start many times. Test in a well ventilated area.
2	Close all vehicle doors, hood and trunk.
3	Press LOCK button three times [3x] rapidly on the OEM keyfob to remote start vehicle.
	Question 1: Does the vehicle remote start?
<input type="checkbox"/>	YES: Go to next step.
<input type="checkbox"/>	NO: The module doesn't detect OEM remote lock button from the vehicle communication network. Check all connections, repeat the test and call technical support, if the problem persists.
4	Press LOCK button three times [3x] rapidly on the OEM keyfob to shut down vehicle.
	Question 2: Does the vehicle shut down?
<input type="checkbox"/>	YES: Go to next step.
<input type="checkbox"/>	NO: Repeat step. If the problem persists, press on the brake pedal once [1x] to shut down the vehicle and call technical support.
5	RAP Shutdown test
	Question 3: Did the radio, interior controls, and headlights turn off within 60 seconds after remote start shutdown?
<input type="checkbox"/>	YES: Go to next step.
<input type="checkbox"/>	NO: Verify the RAP SHUTDOWN connections as illustrated in the wiring diagram. Repeat the test and call technical support, if the problem persists.
6	Open hood.
7	If not already installed, affix the mandatory orange warning sticker under the hood and proceed to next step.
8	Press LOCK button three times [3x] rapidly on the OEM keyfob to remote start vehicle.
	Question 4: Does the vehicle remote start?
<input type="checkbox"/>	YES: The vehicle is not equipped with a factory hood pin. Install a mandatory aftermarket hood switch, then repeat the test.
<input type="checkbox"/>	NO: Go to next step.
9	Close hood.
10	Enter vehicle and close the doors.
11	Press LOCK button three times [3x] rapidly on the OEM keyfob to remote start vehicle.
12	Wait for the vehicle to start.
13	Press brake pedal.
	Question 5: Does the vehicle shut down?
<input type="checkbox"/>	YES: Go to next step.
<input type="checkbox"/>	NO: The module does NOT detect the brake pedal signal. Press LOCK button three times [3x] rapidly on the OEM keyfob to shut down, check the brake connection as illustrated in the wiring diagram, if applicable, and call technical support.
14	Exit vehicle.
15	Installation checklist completed.



INSTALL GUIDE

2014-2018 MAZDA 3 SEDAN PTS MT

DOCUMENT NUMBER

REVISION DATE

20180829

FIRMWARE

ADS-RSA-MA3-[HCX000A]

HARDWARE

HCX000A

ACCESSORIES

ATTENTION: TO COMPLETE THIS INSTALLATION SOME ACCESSORIES MAY BE REQUIRED. VISIT OUR WEBSITE TO SEE ALL THE REQUIRED ACCESSORIES FOR YOUR VEHICLE.

TERMS OF USE

Automotive Data Solutions Inc. ("ADS") products are strictly intended for installation by Certified Technicians who are employed by a registered business specialized in the installation of automotive aftermarket electronics products. Prior to beginning installation of an ADS product in a vehicle, it is the Certified Technician's responsibility to review the most current Product Guide, Install Guide and vehicle-specific notes available in Weblink®. ADS is not responsible for any damages whatsoever, including but not limited to any consequential damages, incidental damages, damages for loss of time, loss of earnings, loss of profit, commercial loss, loss of economic opportunity and the like that may or may not have resulted from the use, misuse, improper installation or operation of its products. ADS reserves itself the right to suspend any Weblink® account without notice and decline to offer technical support to non-Certified Technicians, non-compliant Certified Technicians or end users.



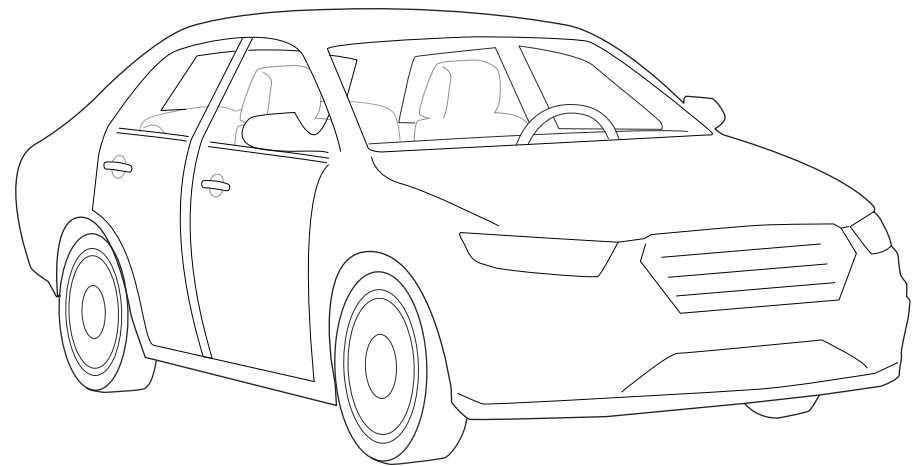
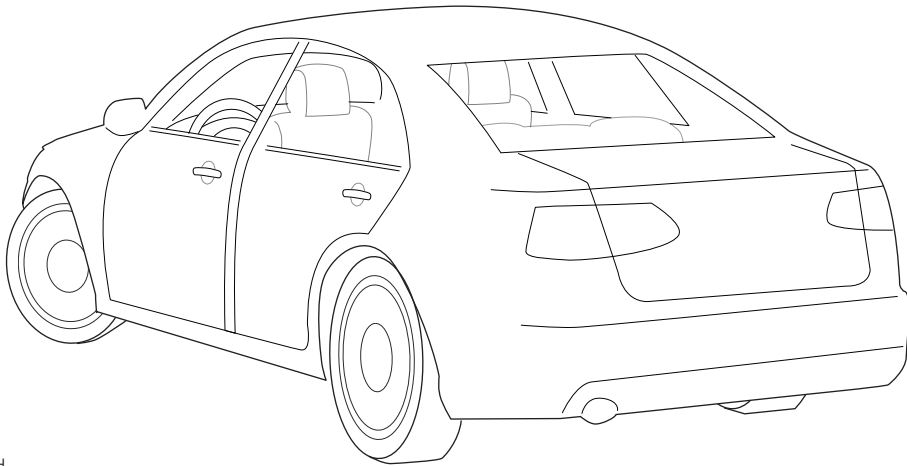
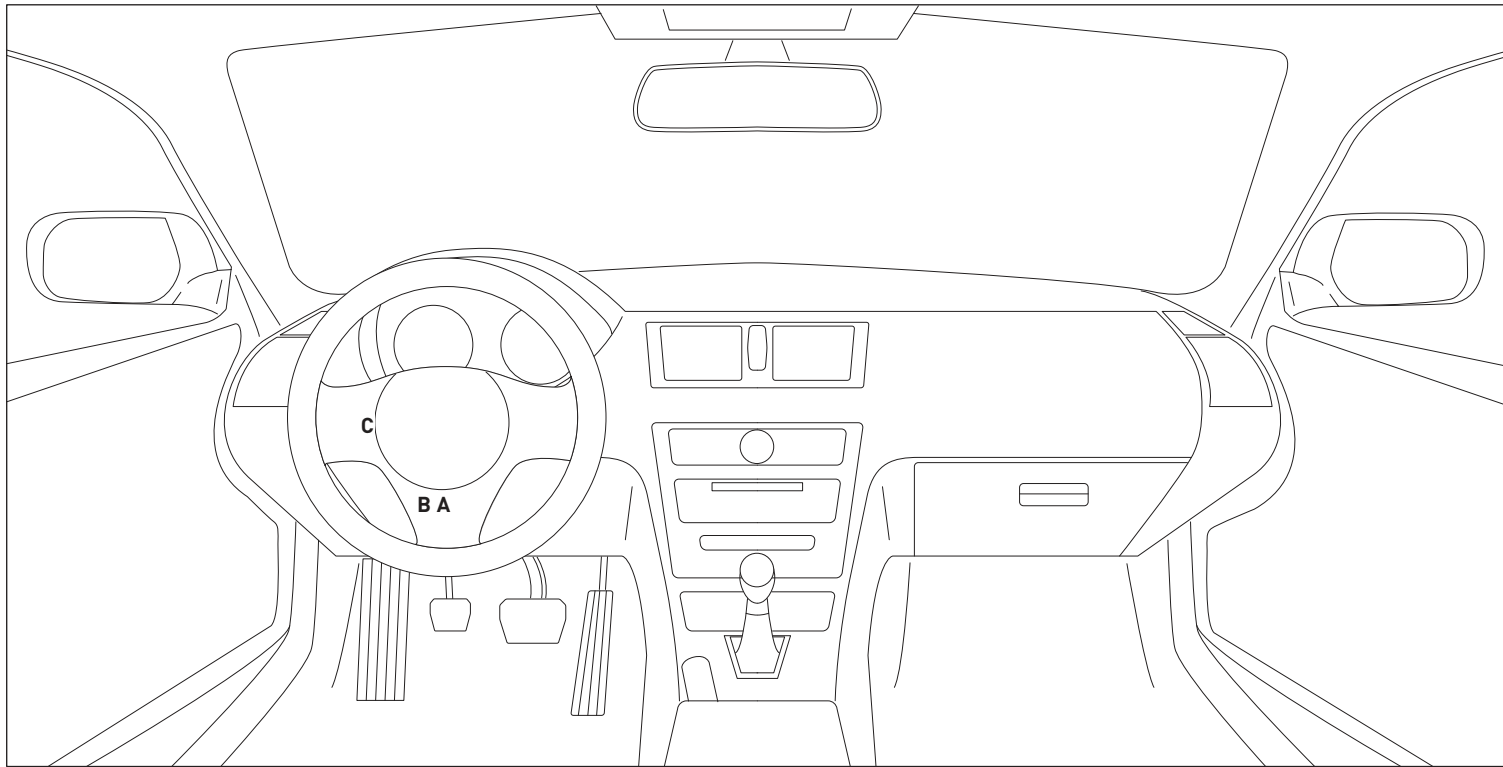

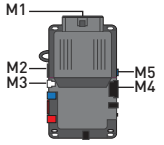

MANDATORY STEPS FOR MANUAL TRANSMISSION:
 1- DO NOT CUT THE LOOP.
 2- CONNECT THE MANUAL TRANSMISSION DIGITAL SENSOR.
 3- SEE THE PRODUCT GUIDE FOR MORE INFORMATION.

DISCONNECT BATTERY BEFORE ATTEMPTING INSTALLATION

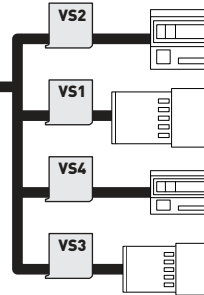
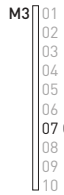

08 WHITE/PURPLE•BLACK DOT - STARTER (-) OUTPUT
 10 WHITE/BLACK•BLACK DOT - HORN (-) OUTPUT
 12 WHITE•BLACK DOT - PARKING LIGHT (-) OUTPUT

GRAY•BLUE DOT
 -GRAY/BLACK•BLUE DOT
 -GRAY/RED•BLUE DOT

(SWITCH SIDE)
 (CONNECTOR SIDE)

CLUTCH (-) RED - 18

HORN (-) BLUE - 01

OPTIONAL

PARKING LIGHT 1 (-) YELLOW - 03

PARKING LIGHT 2 (-) GREEN - 04

HOOD SWITCH

INSTALL THE SUPPLIED HOOD SWITCH IF THE VEHICLE IS NOT EQUIPPED WITH ONE
 SET THE PROGRAMMING OPTION THROUGH WEBLINK AS FOLLOWS:
 IN "MENU #7 INPUTS CONFIGURATION",
 FOR "4-HOOD INPUT SOURCE" SELECT "1-ANALOG".

START STOP UNIT, UNDER STEERING COLUMN (A)

1: WHITE

1: VEHICLE HARNESS

2: WHITE

2: VEHICLE HARNESS

1: WHITE - JS2

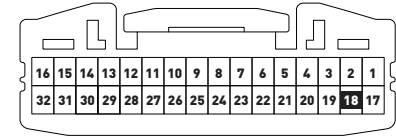

CLOCK SPRING (B)

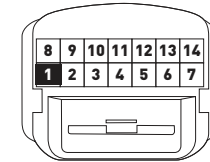

PARKING LIGHTS SWITCH, LEFT OF STEERING COLUMN (C)

1: WHITE

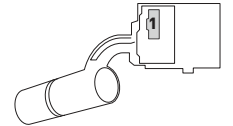
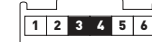

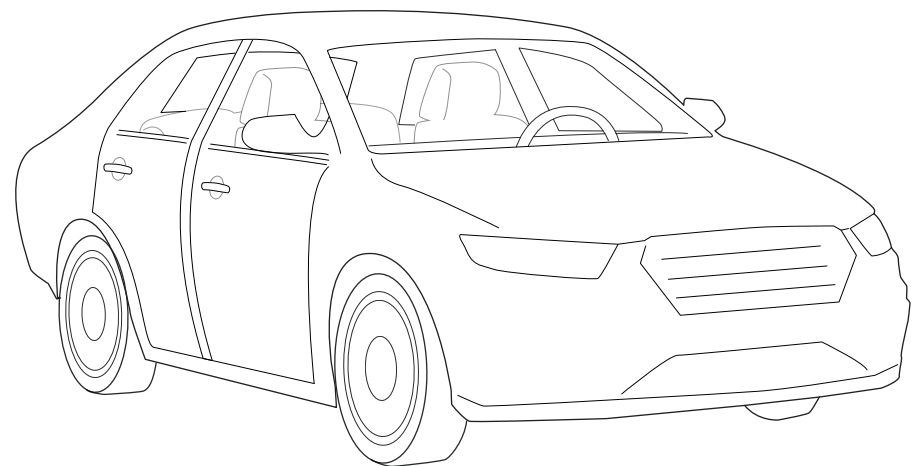
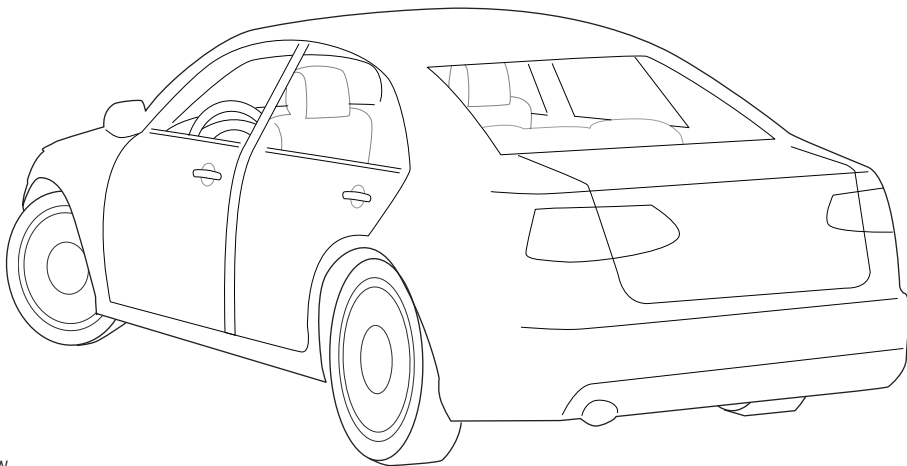
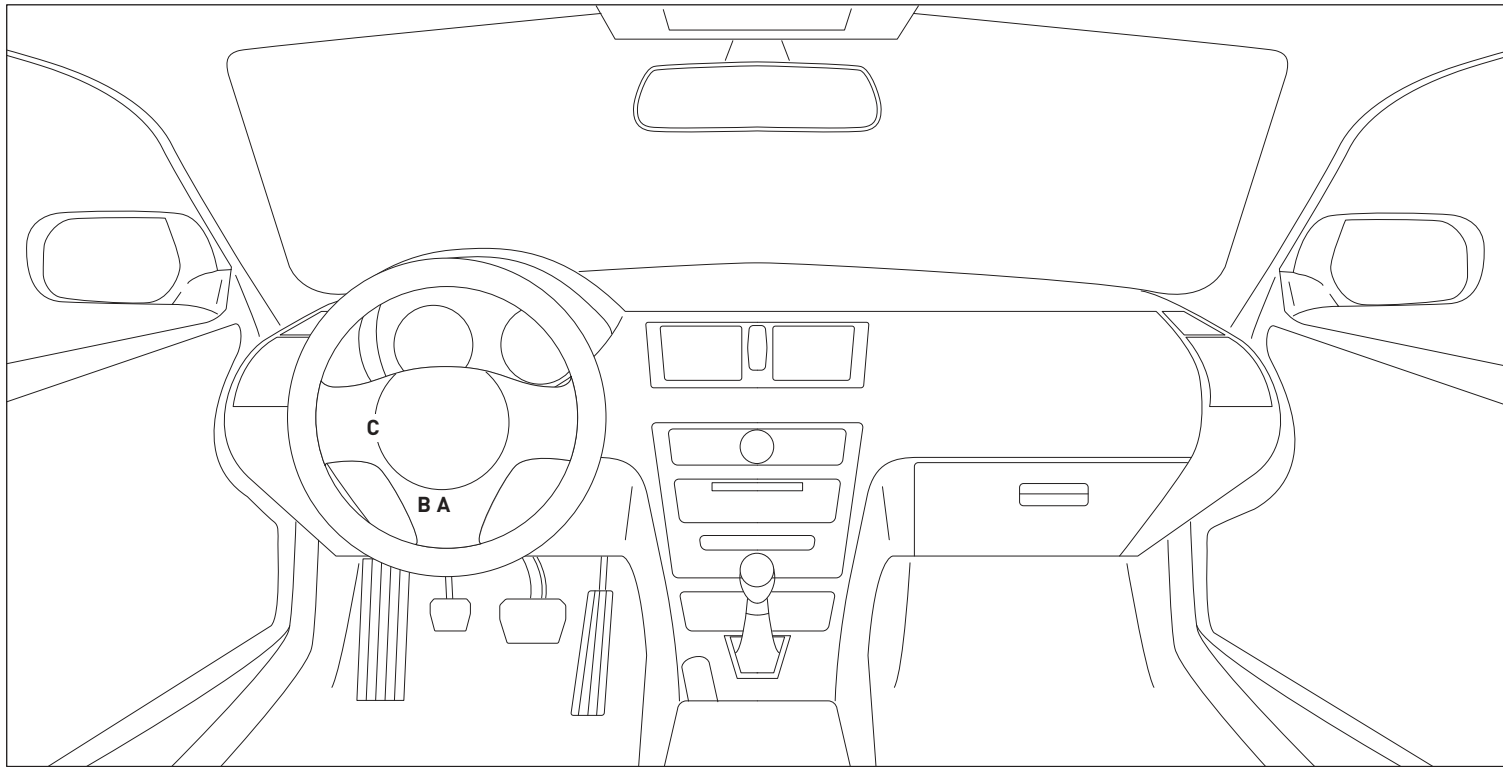

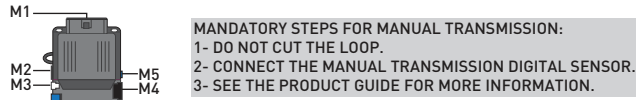

DISCONNECT BATTERY BEFORE ATTEMPTING INSTALLATION

- M1** 01 ORANGE
- 02 RED
- 03 PURPLE
- 04 PINK/WHITE
- 05 PINK
- 06 WHITE
- 07 RED
- 08 BLACK

- M2** 01 GREEN•BLACK DOT
- 02 BLUE•BLACK DOT
- 03 RED/WHITE•BLACK DOT
- 04 GREEN/WHITE•BLACK DOT
- 05 GREEN/BLACK•BLACK DOT
- 06 BLUE/WHITE•BLACK DOT
- 07 EMPTY
- 08 WHITE/PURPLE•BLACK DOT - STARTER (-) OUTPUT
- 09 PURPLE/BLACK•BLACK DOT
- 10 WHITE/BLACK•BLACK DOT - HORN (-) OUTPUT
- 11 BROWN/BLACK•BLACK DOT
- 12 WHITE•BLACK DOT - PARKING LIGHT 1 (-) OUTPUT

- M3** 01 BROWN•SILVER DOT
- 02 BLACK/WHITE•SILVER DOT
- 03 PURPLE•SILVER DOT
- 04 GREEN•SILVER DOT
- 05 PURPLE/WHITE•SILVER DOT
- 06 WHITE/BLUE•SILVER DOT
- 07 GRAY•SILVER DOT - HOOD STATUS (-) INPUT
- 08 BLUE•SILVER DOT
- 09 GRAY/BLACK•SILVER DOT
- 10 EMPTY

- M4** 01 EMPTY
- 02 EMPTY
- 03 BROWN/RED - CANH 1
- 04 BROWN/YELLOW - CANL 1
- 05 BLUE/RED
- 06 BLUE/YELLOW
- 07 EMPTY
- 08 ORANGE
- 09 YELLOW
- 10 EMPTY
- 11 GRAY/RED - PTS (-) OUTPUT
- 12 GRAY/YELLOW
- 13 GREEN/RED - KEYLESS (DATA)
- 14 ORANGE/WHITE
- 15 BROWN - ACCESSORY (+) IN/OUT
- 16 ORANGE/BLACK
- 17 PINK - IGNITION (+) IN/OUT
- 18 PURPLE - STARTER (+) OUTPUT
- 19 RED - 12V (+) INPUT
- 20 BLACK - GROUND (-)

- M5** 01 GRAY/BLACK•BLUE DOT - PARKING LIGHT 2 (-) SWITCH SIDE
- 02 WHITE/BLACK•BLUE DOT - IGNITION (+) VEHICLE SIDE
- 03 GRAY/RED•BLUE DOT - PARKING LIGHT 2 (-) CONNECTOR SIDE
- 04 WHITE/RED•BLUE DOT - IGNITION (+) CONNECTOR SIDE
- 05 GRAY•BLUE DOT
- 06 WHITE•BLUE DOT

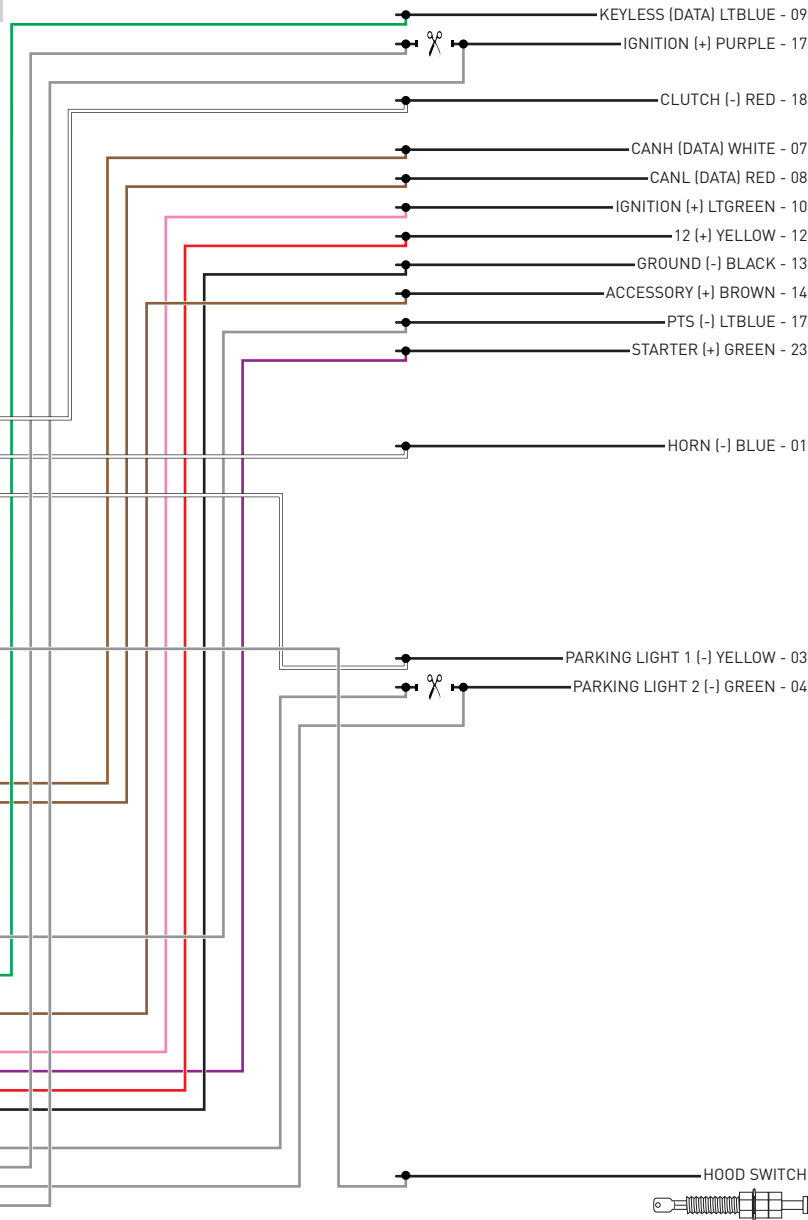

START STOP UNIT, UNDER STEERING COLUMN (A)

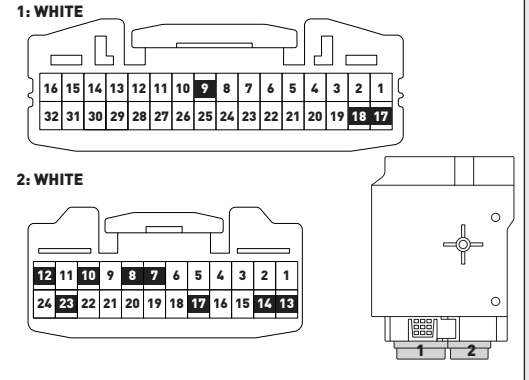

CLOCK SPRING (B)

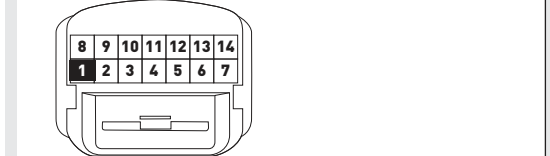

PARKING LIGHTS SWITCH, LEFT OF STEERING COLUMN (C)

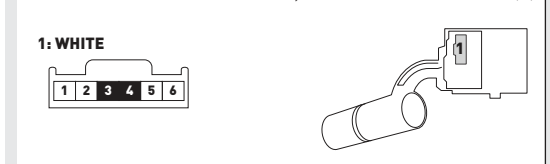

INSTALL THE SUPPLIED HOOD SWITCH IF THE VEHICLE IS NOT EQUIPPED WITH ONE SET THE PROGRAMMING OPTION THROUGH WEBLINK AS FOLLOWS: IN "MENU #7 INPUTS CONFIGURATION", FOR "4-HOOD INPUT SOURCE" SELECT "1-ANALOG".

>>  WARNING: All vehicle doors must be closed and locked prior to remote start sequence.

01  Set ignition to ON position.

02  Wait, LED 1 will turn solid RED to confirm that the ignition is ON.

03  Wait 10 seconds, LED 1 will flash GREEN rapidly.

04  Set ignition to OFF position.

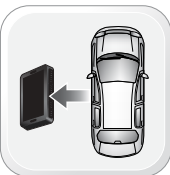
05  WARNING: Disconnect power last. Disconnect module from vehicle.

06  Connect module to computer and proceed with extended programming.

07  Connect power first. Connect module to vehicle.

08  Set ignition to ON position.

09  Wait, LED 1 will turn solid RED to confirm that the ignition is ON.

10  Wait, LED 1 will turn solid GREEN for 2 seconds.

11  Set ignition to OFF position.

>>  If vehicle is equipped with power liftgate: open and close the power liftgate with OEM keyfob.

12  START vehicle for 15 seconds.

13  Press and hold the brake pedal.

14  Press and release the module's programming button.

15  Release the brake pedal.

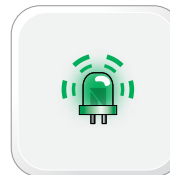
16  Wait, LED 2 will flash GREEN. Module Programming Procedure completed.

>>



All vehicle doors must be closed and locked prior to remote start sequence.

01



Time restriction. Complete steps 2 to 5 within 45 seconds.

02



Press unlock on OEM or aftermarket remote or request switch.

03



Open driver door and enter vehicle.

04



Close driver door.

05



Press and release BRAKE pedal.

06



Take over procedure completed.

>>



Failure to follow procedure will result in vehicle engine shutdown.

CHECKLIST - WITH AFTERMARKET KEYFOB

1	WARNING: Vehicle engine will start many times. Test in a well ventilated area.	9	Press the START/STOP button once [1x] on the aftermarket keyfob to shut down vehicle.
2	Close all vehicle doors, hood and trunk.		Question 7: Does the vehicle shut down?
3	Press the LOCK button once [1x] on the aftermarket keyfob.	<input type="checkbox"/>	YES: Go to next step.
	Question 1: Do the doors lock?	<input type="checkbox"/>	NO: Repeat step. If problem persists, press the brake pedal once [1x] to shut down the vehicle and call technical support.
<input type="checkbox"/>	YES: Go to next step.	10	RAP and auto light shutdown test
<input type="checkbox"/>	NO: Verify the remote programming, the RF connections and the wired door lock/unlock connections as illustrated in the wiring diagram, if applicable. Repeat the test and call technical support, if the problem persists.		Question 8: Did the radio, interior controls and headlights turn off within 60 seconds after remote start shutdown?
4	Press the UNLOCK button once [1x] on the aftermarket keyfob.	<input type="checkbox"/>	YES: Go to next step.
	Question 2: Do the doors unlock?	<input type="checkbox"/>	NO: Verify the RAP SHUTDOWN connections as illustrated in the wiring diagram. Repeat the test and call technical support if the problem persists.
<input type="checkbox"/>	YES: Go to next step.	11	Open hood.
<input type="checkbox"/>	NO: Verify the remote programming, the RF connections and the wired door lock/unlock connections as illustrated in the wiring diagram, if applicable. Repeat the test and call technical support, if the problem persists.	12	If not already installed, affix the mandatory orange warning sticker under the hood and proceed to next step.
5	Press the TRUNK release button once [1x] on the aftermarket keyfob if supported.	13	Press the START/STOP button once [1x] on the aftermarket keyfob to remote start vehicle.
	Question 3: Does the trunk or hatch open/unlock?		Question 9: Does the vehicle remote start?
<input type="checkbox"/>	YES: Close trunk or hatch and go to next step.	<input type="checkbox"/>	YES: The vehicle is not equipped with a factory hood pin. Install a mandatory aftermarket hood switch, then repeat the test.
<input type="checkbox"/>	NO: Verify the remote programming, the RF connections and the wired trunk/hatch connections as illustrated in the wiring diagram, if applicable. Repeat the test and call technical support, if the problem persists.	<input type="checkbox"/>	NO: Go to next step.
6	Press the AUX 1 button once [1x] on the aftermarket keyfob if supported.	14	Close hood.
	Question 4: Does the driver side sliding door open?	15	Enter vehicle and close the doors.
<input type="checkbox"/>	YES: Press the AUX 1 button once [1x] to close the driver sliding door and go to next step.	16	Press the START/STOP button once [1x] on the aftermarket keyfob to remote start vehicle.
<input type="checkbox"/>	NO: Verify the remote programming and the RF connections. Repeat the test and call technical support, if the problem persists.	17	Wait for the vehicle to start.
7	Press the AUX 2 button once [1x] on the aftermarket keyfob if supported.	18	Press brake pedal.
	Question 5: Does the passenger side sliding door open?		Question 10: Does the vehicle shut down?
<input type="checkbox"/>	YES: Press the AUX 2 button once [1x] to close the passenger sliding door and go to next step.	<input type="checkbox"/>	YES: Go to next step.
<input type="checkbox"/>	NO: Verify the remote programming and the RF connections. Repeat the test and call technical support, if the problem persists.	<input type="checkbox"/>	NO: The module does NOT detect the brake pedal signal. Press the START/STOP button once [1x] on the aftermarket keyfob to shut down vehicle, check connection as illustrated in the wiring diagram, if applicable, and call technical support.
8	Press the START/STOP button once [1x] on the aftermarket keyfob to remote start vehicle.	19	Exit vehicle.
	Question 6: Does the vehicle remote start?	20	Installation checklist completed.
<input type="checkbox"/>	YES: Go to next step.		
<input type="checkbox"/>	NO: Verify the remote programming, the RF connections and check the remote start error codes. Repeat the test and call technical support, if the problem persists.		

CHECKLIST - WITH OEM KEYFOB

1	WARNING: Vehicle engine will start many times. Test in a well ventilated area.
2	Close all vehicle doors, hood and trunk.
3	Press LOCK button three times [3x] rapidly on the OEM keyfob to remote start vehicle.
	Question 1: Does the vehicle remote start?
<input type="checkbox"/>	YES: Go to next step.
<input type="checkbox"/>	NO: The module doesn't detect OEM remote lock button from the vehicle communication network. Check all connections, repeat the test and call technical support, if the problem persists.
4	Press LOCK button three times [3x] rapidly on the OEM keyfob to shut down vehicle.
	Question 2: Does the vehicle shut down?
<input type="checkbox"/>	YES: Go to next step.
<input type="checkbox"/>	NO: Repeat step. If the problem persists, press on the brake pedal once [1x] to shut down the vehicle and call technical support.
5	RAP Shutdown test
	Question 3: Did the radio, interior controls, and headlights turn off within 60 seconds after remote start shutdown?
<input type="checkbox"/>	YES: Go to next step.
<input type="checkbox"/>	NO: Verify the RAP SHUTDOWN connections as illustrated in the wiring diagram. Repeat the test and call technical support, if the problem persists.
6	Open hood.
7	If not already installed, affix the mandatory orange warning sticker under the hood and proceed to next step.
8	Press LOCK button three times [3x] rapidly on the OEM keyfob to remote start vehicle.
	Question 4: Does the vehicle remote start?
<input type="checkbox"/>	YES: The vehicle is not equipped with a factory hood pin. Install a mandatory aftermarket hood switch, then repeat the test.
<input type="checkbox"/>	NO: Go to next step.
9	Close hood.
10	Enter vehicle and close the doors.
11	Press LOCK button three times [3x] rapidly on the OEM keyfob to remote start vehicle.
12	Wait for the vehicle to start.
13	Press brake pedal.
	Question 5: Does the vehicle shut down?
<input type="checkbox"/>	YES: Go to next step.
<input type="checkbox"/>	NO: The module does NOT detect the brake pedal signal. Press LOCK button three times [3x] rapidly on the OEM keyfob to shut down, check the brake connection as illustrated in the wiring diagram, if applicable, and call technical support.
14	Exit vehicle.
15	Installation checklist completed.



INSTALL GUIDE

2014-2018 MAZDA 6 PTS AT

DOCUMENT NUMBER

REVISION DATE
20180829

FIRMWARE
ADS-RSA-MA3-[HCX000A]

HARDWARE
HCX000A

ACCESSORIES

ATTENTION: TO COMPLETE THIS INSTALLATION SOME ACCESSORIES MAY BE REQUIRED. VISIT OUR WEBSITE TO SEE ALL THE REQUIRED ACCESSORIES FOR YOUR VEHICLE.

TERMS OF USE

Automotive Data Solutions Inc. ("ADS") products are strictly intended for installation by Certified Technicians who are employed by a registered business specialized in the installation of automotive aftermarket electronics products. Prior to beginning installation of an ADS product in a vehicle, it is the Certified Technician's responsibility to review the most current Product Guide, Install Guide and vehicle-specific notes available in Weblink®. ADS is not responsible for any damages whatsoever, including but not limited to any consequential damages, incidental damages, damages for loss of time, loss of earnings, loss of profit, commercial loss, loss of economic opportunity and the like that may or may not have resulted from the use, misuse, improper installation or operation of its products. ADS reserves itself the right to suspend any Weblink® account without notice and decline to offer technical support to non-Certified Technicians, non-compliant Certified Technicians or end users.



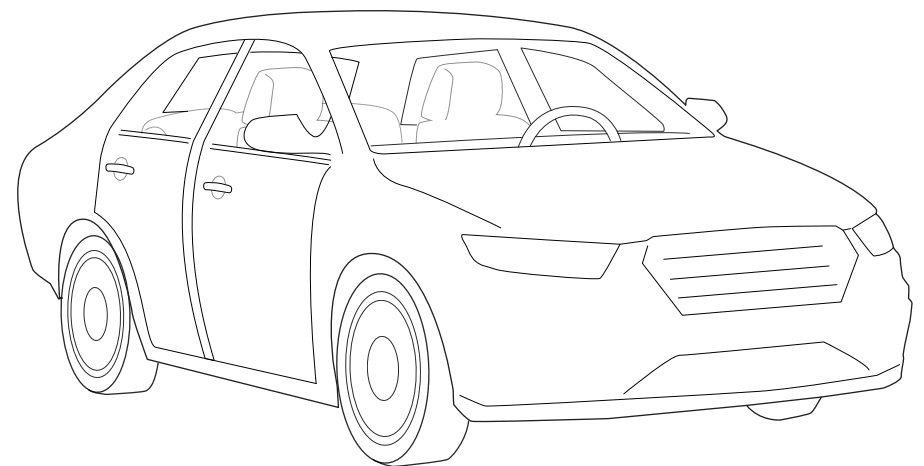
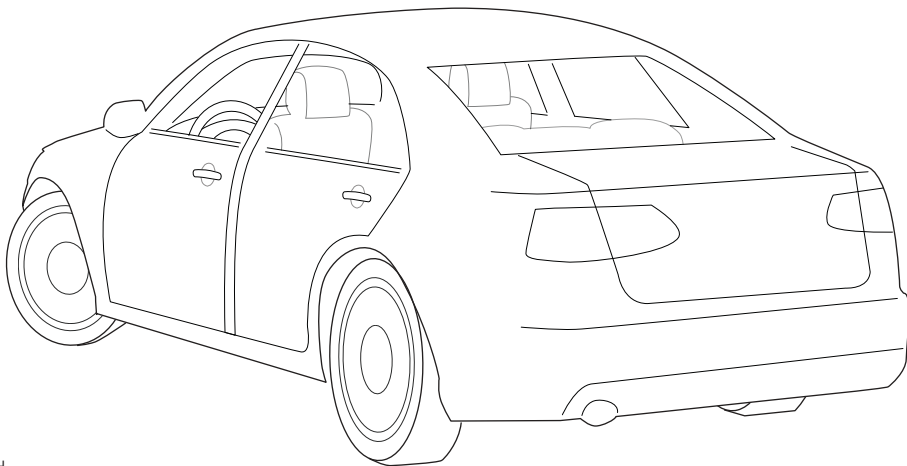
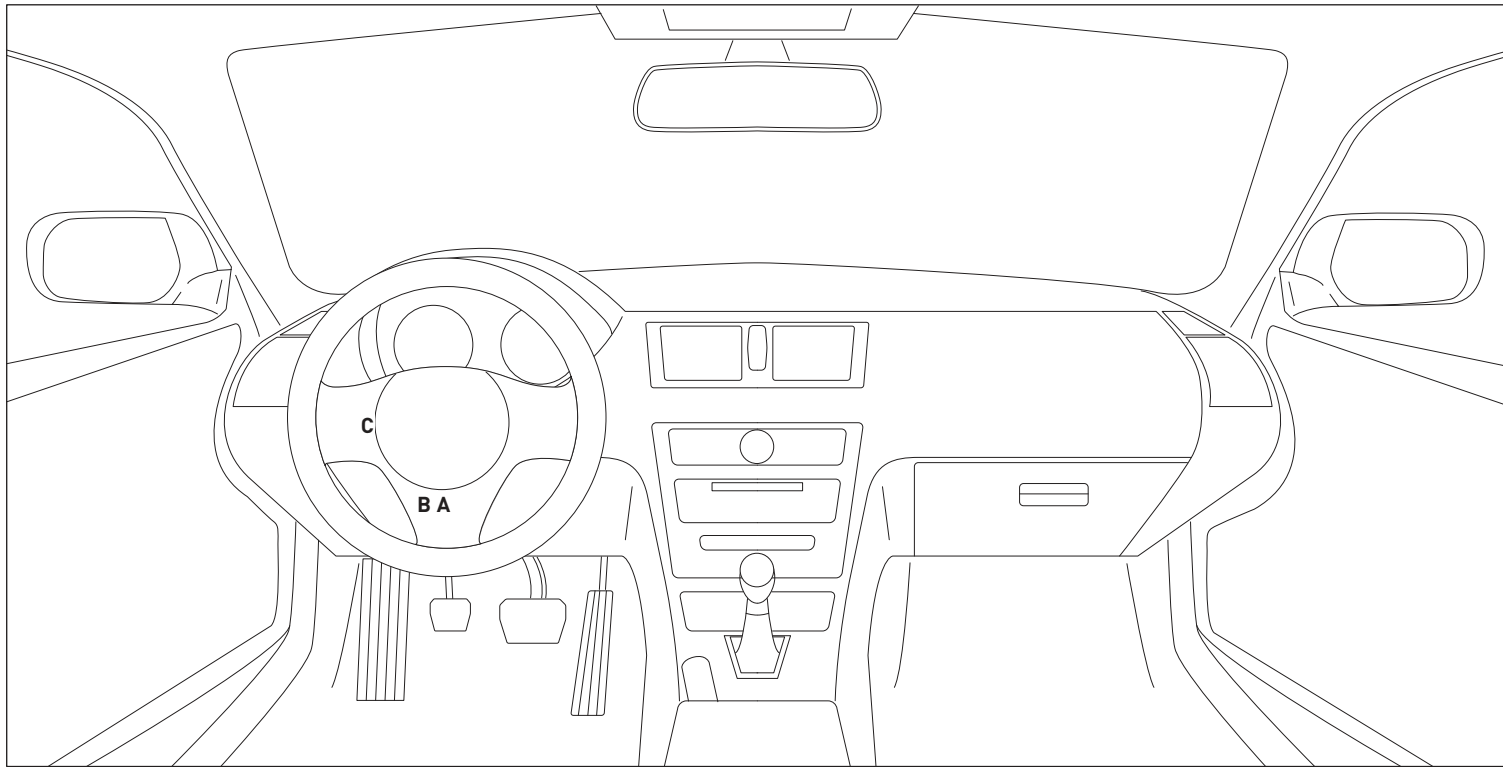

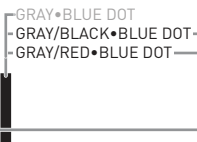
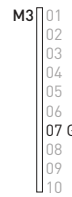
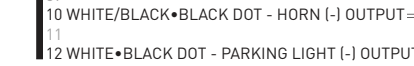
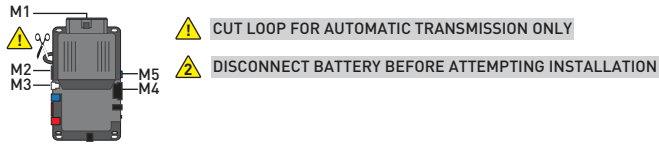

MS1



MS2

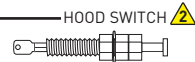
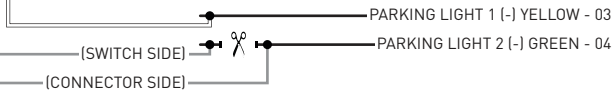
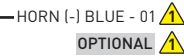
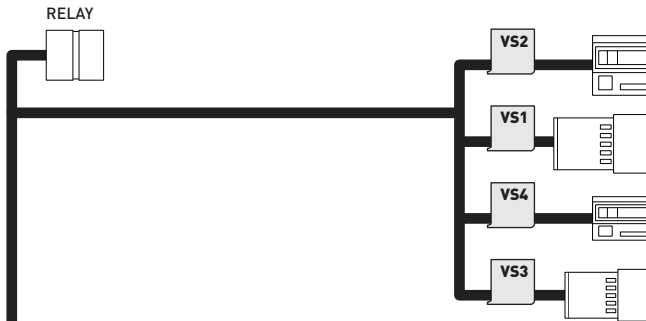

⚠ INSTALL THE SUPPLIED HOOD SWITCH IF THE VEHICLE IS NOT EQUIPPED WITH ONE
⚠ SET THE PROGRAMMING OPTION THROUGH WEBLINK AS FOLLOWS:
 IN "MENU #7 INPUTS CONFIGURATION",
 FOR "4-HOOD INPUT SOURCE" SELECT "1-ANALOG".

START STOP UNIT, UNDER STEERING COLUMN (B)

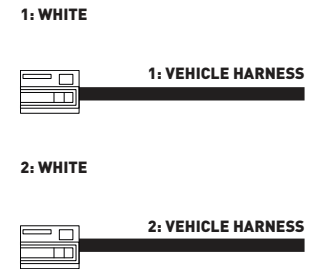

CLOCK SPRING (D)

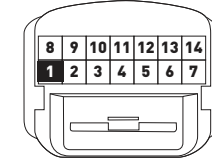

PARKING LIGHTS SWITCH, LEFT OF STEERING COLUMN (C)

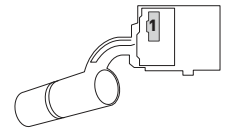
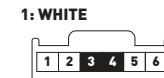

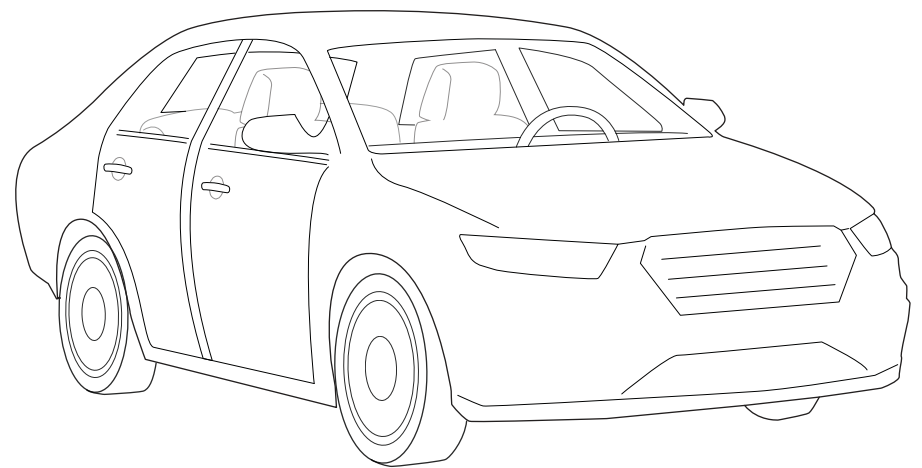
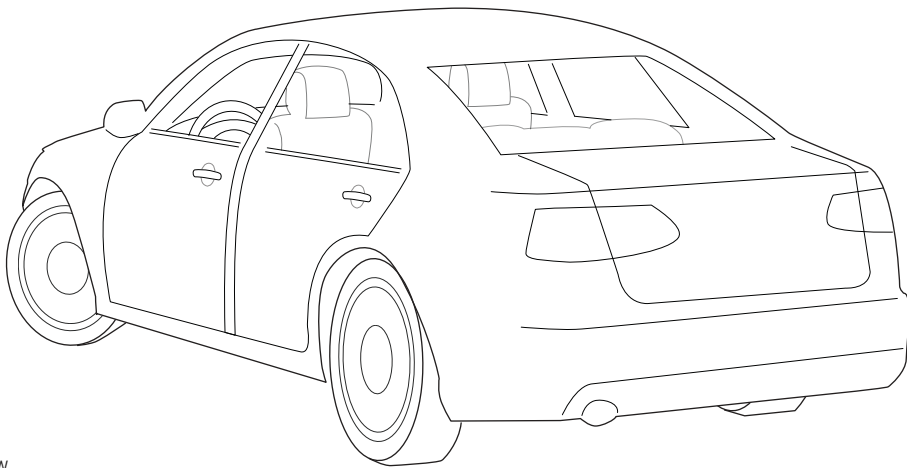
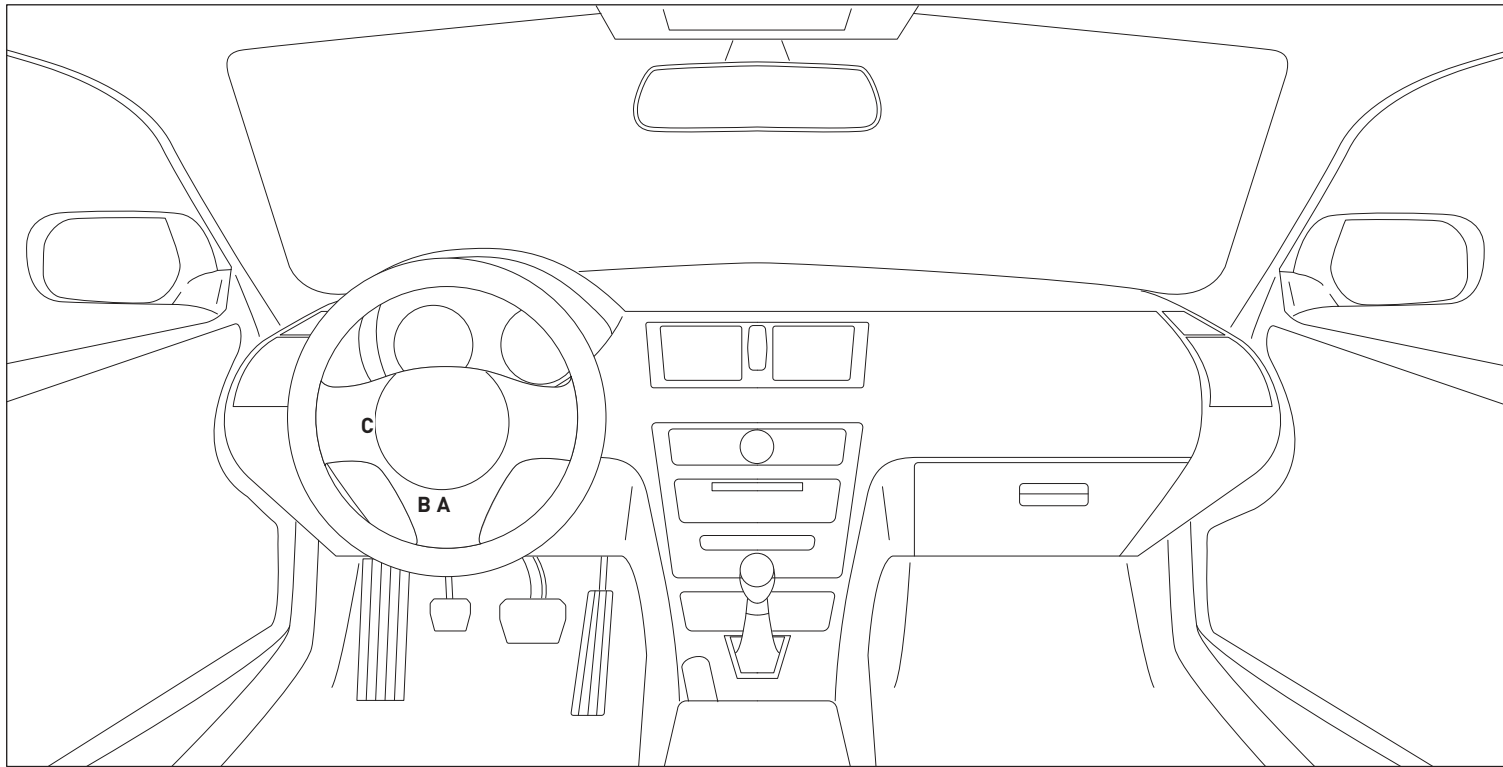

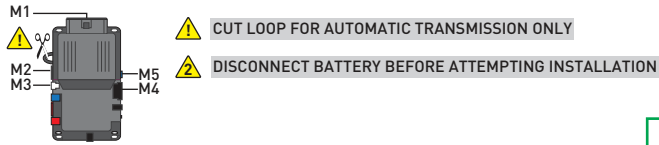

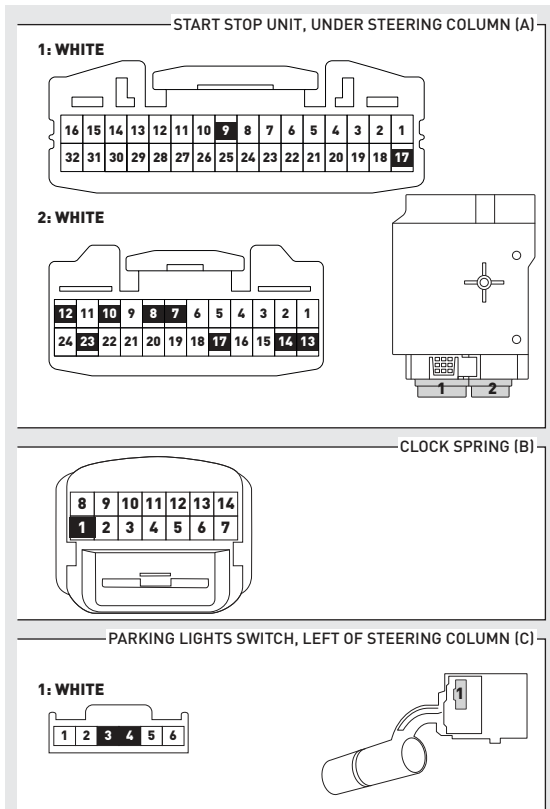
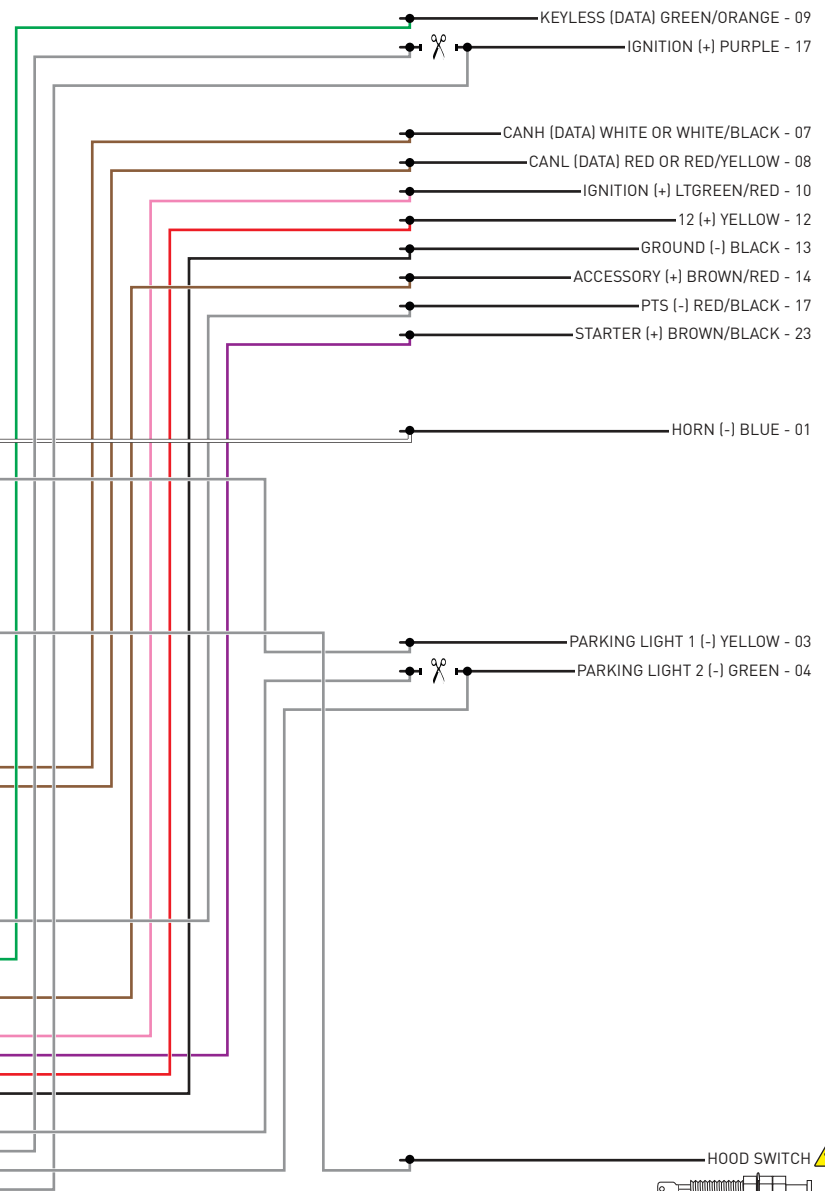

- M1**
 - 01 ORANGE
 - 02 RED
 - 03 PURPLE
 - 04 PINK/WHITE
 - 05 PINK
 - 06 WHITE
 - 07 RED
 - 08 BLACK
- M2**
 - 01 GREEN•BLACK DOT
 - 02 BLUE•BLACK DOT
 - 03 RED/WHITE•BLACK DOT
 - 04 GREEN/WHITE•BLACK DOT
 - 05 GREEN/BLACK•BLACK DOT
 - 06 BLUE/WHITE•BLACK DOT
 - 07 EMPTY
 - 08 WHITE/PURPLE•BLACK DOT
 - 09 PURPLE/BLACK•BLACK DOT
 - 10 WHITE/BLACK•BLACK DOT - HORN (-) OUTPUT
 - 11 BROWN/BLACK•BLACK DOT
 - 12 WHITE•BLACK DOT - PARKING LIGHT 1 (-) OUTPUT
- M3**
 - 01 BROWN•SILVER DOT
 - 02 BLACK/WHITE•SILVER DOT
 - 03 PURPLE•SILVER DOT
 - 04 GREEN•SILVER DOT
 - 05 PURPLE/WHITE•SILVER DOT
 - 06 WHITE/BLUE•SILVER DOT
 - 07 GRAY•SILVER DOT - HOOD STATUS (-) INPUT
 - 08 BLUE•SILVER DOT
 - 09 GRAY/BLACK•SILVER DOT
 - 10 EMPTY
- M4**
 - 01 EMPTY
 - 02 EMPTY
 - 03 BROWN/RED - CANH 1
 - 04 BROWN/YELLOW - CANL 1
 - 05 BLUE/RED
 - 06 BLUE/YELLOW
 - 07 EMPTY
 - 08 ORANGE
 - 09 YELLOW
 - 10 EMPTY
 - 11 GRAY/RED - PTS (-) OUTPUT
 - 12 GRAY/YELLOW
 - 13 GREEN/RED - KEYLESS (DATA)
 - 14 ORANGE/WHITE
 - 15 BROWN - ACCESSORY (+) IN/OUT
 - 16 ORANGE/BLACK
 - 17 PINK - IGNITION (+) IN/OUT
 - 18 PURPLE - STARTER (+) OUTPUT
 - 19 RED - 12V (+) INPUT
 - 20 BLACK - GROUND (-)
- M5**
 - 01 GRAY/BLACK•BLUE DOT - PARKING LIGHT 2 (-) SWITCH SIDE
 - 02 WHITE/BLACK•BLUE DOT - IGNITION (+)
 - 03 GRAY/RED•BLUE DOT - PARKING LIGHT 2 (-) CONNECTOR SIDE
 - 04 WHITE/RED•BLUE DOT - IGNITION (+)
 - 05 GRAY•BLUE DOT
 - 06 WHITE•BLUE DOT



⚠ INSTALL THE SUPPLIED HOOD SWITCH IF THE VEHICLE IS NOT EQUIPPED WITH ONE SET THE PROGRAMMING OPTION THROUGH WEBLINK AS FOLLOWS: IN "MENU #7 INPUTS CONFIGURATION", FOR "4-HOOD INPUT SOURCE" SELECT "1-ANALOG".

>>  WARNING: All vehicle doors must be closed and locked prior to remote start sequence.

01  Set ignition to ON position.

02  Wait, LED 1 will turn solid RED to confirm that the ignition is ON.

03  Wait 10 seconds, LED 1 will flash GREEN rapidly.

04  Set ignition to OFF position.

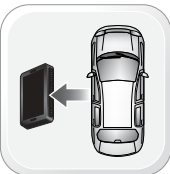
05  WARNING: Disconnect power last. Disconnect module from vehicle.

06  Connect module to computer and proceed with extended programming.

07  Connect power first. Connect module to vehicle.

08  Set ignition to ON position.

09  Wait, LED 1 will turn solid RED to confirm that the ignition is ON.

10  Wait, LED 1 will turn solid GREEN for 2 seconds.

11  Set ignition to OFF position.

>>  If vehicle is equipped with power liftgate: open and close the power liftgate with OEM keyfob.

12  START vehicle for 15 seconds.

13  Press and hold the brake pedal.

14  Press and release the module's programming button.

15  Release the brake pedal.

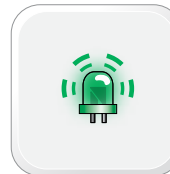
16  Wait, LED 2 will flash GREEN. Module Programming Procedure completed.

>>



All vehicle doors must be closed and locked prior to remote start sequence.

01



Time restriction. Complete steps 2 to 5 within 45 seconds.

02



Press unlock on OEM or aftermarket remote or request switch.

03



Open driver door and enter vehicle.

04



Close driver door.

05



Press and release BRAKE pedal.

06



Take over procedure completed.

>>



Failure to follow procedure will result in vehicle engine shutdown.

CHECKLIST - WITH AFTERMARKET KEYFOB

1	WARNING: Vehicle engine will start many times. Test in a well ventilated area.	9	Press the START/STOP button once [1x] on the aftermarket keyfob to shut down vehicle.
2	Close all vehicle doors, hood and trunk.		Question 7: Does the vehicle shut down?
3	Press the LOCK button once [1x] on the aftermarket keyfob.	<input type="checkbox"/>	YES: Go to next step.
	Question 1: Do the doors lock?	<input type="checkbox"/>	NO: Repeat step. If problem persists, press the brake pedal once [1x] to shut down the vehicle and call technical support.
<input type="checkbox"/>	YES: Go to next step.	10	RAP and auto light shutdown test
<input type="checkbox"/>	NO: Verify the remote programming, the RF connections and the wired door lock/unlock connections as illustrated in the wiring diagram, if applicable. Repeat the test and call technical support, if the problem persists.		Question 8: Did the radio, interior controls and headlights turn off within 60 seconds after remote start shutdown?
4	Press the UNLOCK button once [1x] on the aftermarket keyfob.	<input type="checkbox"/>	YES: Go to next step.
	Question 2: Do the doors unlock?	<input type="checkbox"/>	NO: Verify the RAP SHUTDOWN connections as illustrated in the wiring diagram. Repeat the test and call technical support if the problem persists.
<input type="checkbox"/>	YES: Go to next step.	11	Open hood.
<input type="checkbox"/>	NO: Verify the remote programming, the RF connections and the wired door lock/unlock connections as illustrated in the wiring diagram, if applicable. Repeat the test and call technical support, if the problem persists.	12	If not already installed, affix the mandatory orange warning sticker under the hood and proceed to next step.
5	Press the TRUNK release button once [1x] on the aftermarket keyfob if supported.	13	Press the START/STOP button once [1x] on the aftermarket keyfob to remote start vehicle.
	Question 3: Does the trunk or hatch open/unlock?		Question 9: Does the vehicle remote start?
<input type="checkbox"/>	YES: Close trunk or hatch and go to next step.	<input type="checkbox"/>	YES: The vehicle is not equipped with a factory hood pin. Install a mandatory aftermarket hood switch, then repeat the test.
<input type="checkbox"/>	NO: Verify the remote programming, the RF connections and the wired trunk/hatch connections as illustrated in the wiring diagram, if applicable. Repeat the test and call technical support, if the problem persists.	<input type="checkbox"/>	NO: Go to next step.
6	Press the AUX 1 button once [1x] on the aftermarket keyfob if supported.	14	Close hood.
	Question 4: Does the driver side sliding door open?	15	Enter vehicle and close the doors.
<input type="checkbox"/>	YES: Press the AUX 1 button once [1x] to close the driver sliding door and go to next step.	16	Press the START/STOP button once [1x] on the aftermarket keyfob to remote start vehicle.
<input type="checkbox"/>	NO: Verify the remote programming and the RF connections. Repeat the test and call technical support, if the problem persists.	17	Wait for the vehicle to start.
7	Press the AUX 2 button once [1x] on the aftermarket keyfob if supported.	18	Press brake pedal.
	Question 5: Does the passenger side sliding door open?		Question 10: Does the vehicle shut down?
<input type="checkbox"/>	YES: Press the AUX 2 button once [1x] to close the passenger sliding door and go to next step.	<input type="checkbox"/>	YES: Go to next step.
<input type="checkbox"/>	NO: Verify the remote programming and the RF connections. Repeat the test and call technical support, if the problem persists.	<input type="checkbox"/>	NO: The module does NOT detect the brake pedal signal. Press the START/STOP button once [1x] on the aftermarket keyfob to shut down vehicle, check connection as illustrated in the wiring diagram, if applicable, and call technical support.
8	Press the START/STOP button once [1x] on the aftermarket keyfob to remote start vehicle.	19	Exit vehicle.
	Question 6: Does the vehicle remote start?	20	Installation checklist completed.
<input type="checkbox"/>	YES: Go to next step.		
<input type="checkbox"/>	NO: Verify the remote programming, the RF connections and check the remote start error codes. Repeat the test and call technical support, if the problem persists.		

CHECKLIST - WITH OEM KEYFOB

1	WARNING: Vehicle engine will start many times. Test in a well ventilated area.
2	Close all vehicle doors, hood and trunk.
3	Press LOCK button three times [3x] rapidly on the OEM keyfob to remote start vehicle.
	Question 1: Does the vehicle remote start?
<input type="checkbox"/>	YES: Go to next step.
<input type="checkbox"/>	NO: The module doesn't detect OEM remote lock button from the vehicle communication network. Check all connections, repeat the test and call technical support, if the problem persists.
4	Press LOCK button three times [3x] rapidly on the OEM keyfob to shut down vehicle.
	Question 2: Does the vehicle shut down?
<input type="checkbox"/>	YES: Go to next step.
<input type="checkbox"/>	NO: Repeat step. If the problem persists, press on the brake pedal once [1x] to shut down the vehicle and call technical support.
5	RAP Shutdown test
	Question 3: Did the radio, interior controls, and headlights turn off within 60 seconds after remote start shutdown?
<input type="checkbox"/>	YES: Go to next step.
<input type="checkbox"/>	NO: Verify the RAP SHUTDOWN connections as illustrated in the wiring diagram. Repeat the test and call technical support, if the problem persists.
6	Open hood.
7	If not already installed, affix the mandatory orange warning sticker under the hood and proceed to next step.
8	Press LOCK button three times [3x] rapidly on the OEM keyfob to remote start vehicle.
	Question 4: Does the vehicle remote start?
<input type="checkbox"/>	YES: The vehicle is not equipped with a factory hood pin. Install a mandatory aftermarket hood switch, then repeat the test.
<input type="checkbox"/>	NO: Go to next step.
9	Close hood.
10	Enter vehicle and close the doors.
11	Press LOCK button three times [3x] rapidly on the OEM keyfob to remote start vehicle.
12	Wait for the vehicle to start.
13	Press brake pedal.
	Question 5: Does the vehicle shut down?
<input type="checkbox"/>	YES: Go to next step.
<input type="checkbox"/>	NO: The module does NOT detect the brake pedal signal. Press LOCK button three times [3x] rapidly on the OEM keyfob to shut down, check the brake connection as illustrated in the wiring diagram, if applicable, and call technical support.
14	Exit vehicle.
15	Installation checklist completed.



INSTALL GUIDE

2014-2018 MAZDA 6 PTS MT



DOCUMENT NUMBER

REVISION DATE
20180829

FIRMWARE
ADS-RSA-MA3-[HCX000A]

HARDWARE
HCX000A

ACCESSORIES

ATTENTION: TO COMPLETE THIS INSTALLATION SOME ACCESSORIES MAY BE REQUIRED. VISIT OUR WEBSITE TO SEE ALL THE REQUIRED ACCESSORIES FOR YOUR VEHICLE.

TERMS OF USE

Automotive Data Solutions Inc. ("ADS") products are strictly intended for installation by Certified Technicians who are employed by a registered business specialized in the installation of automotive aftermarket electronics products. Prior to beginning installation of an ADS product in a vehicle, it is the Certified Technician's responsibility to review the most current Product Guide, Install Guide and vehicle-specific notes available in Weblink®. ADS is not responsible for any damages whatsoever, including but not limited to any consequential damages, incidental damages, damages for loss of time, loss of earnings, loss of profit, commercial loss, loss of economic opportunity and the like that may or may not have resulted from the use, misuse, improper installation or operation of its products. ADS reserves itself the right to suspend any Weblink® account without notice and decline to offer technical support to non-Certified Technicians, non-compliant Certified Technicians or end users.

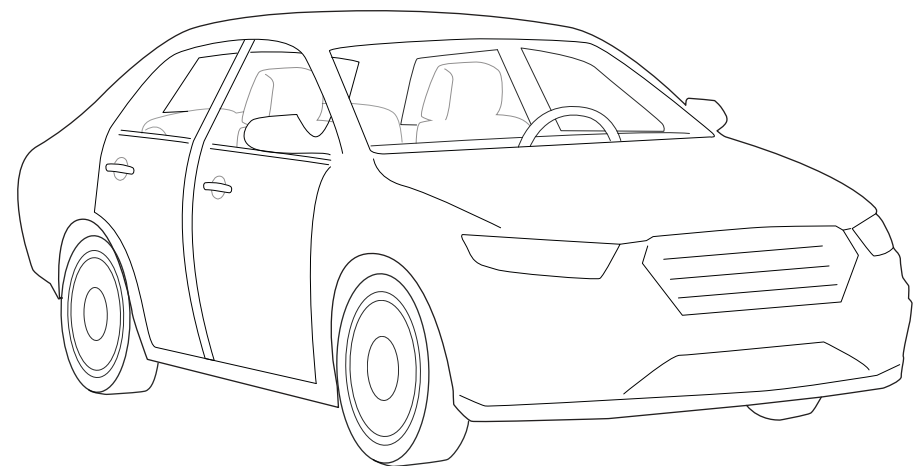
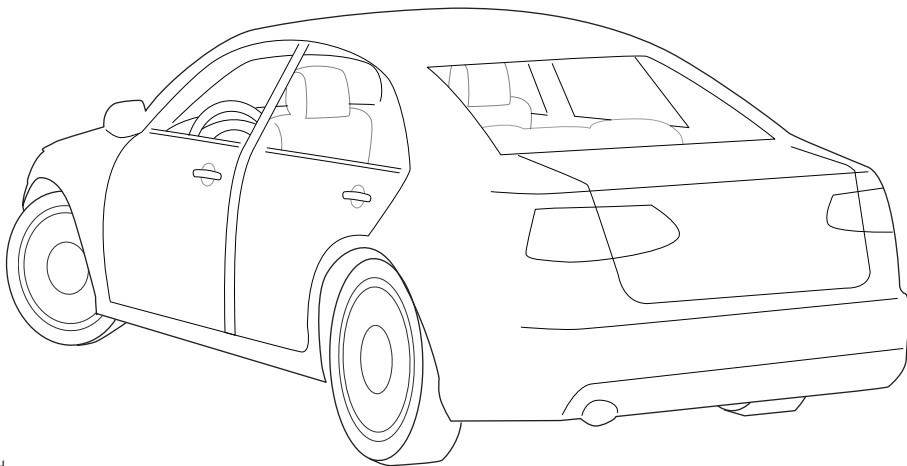
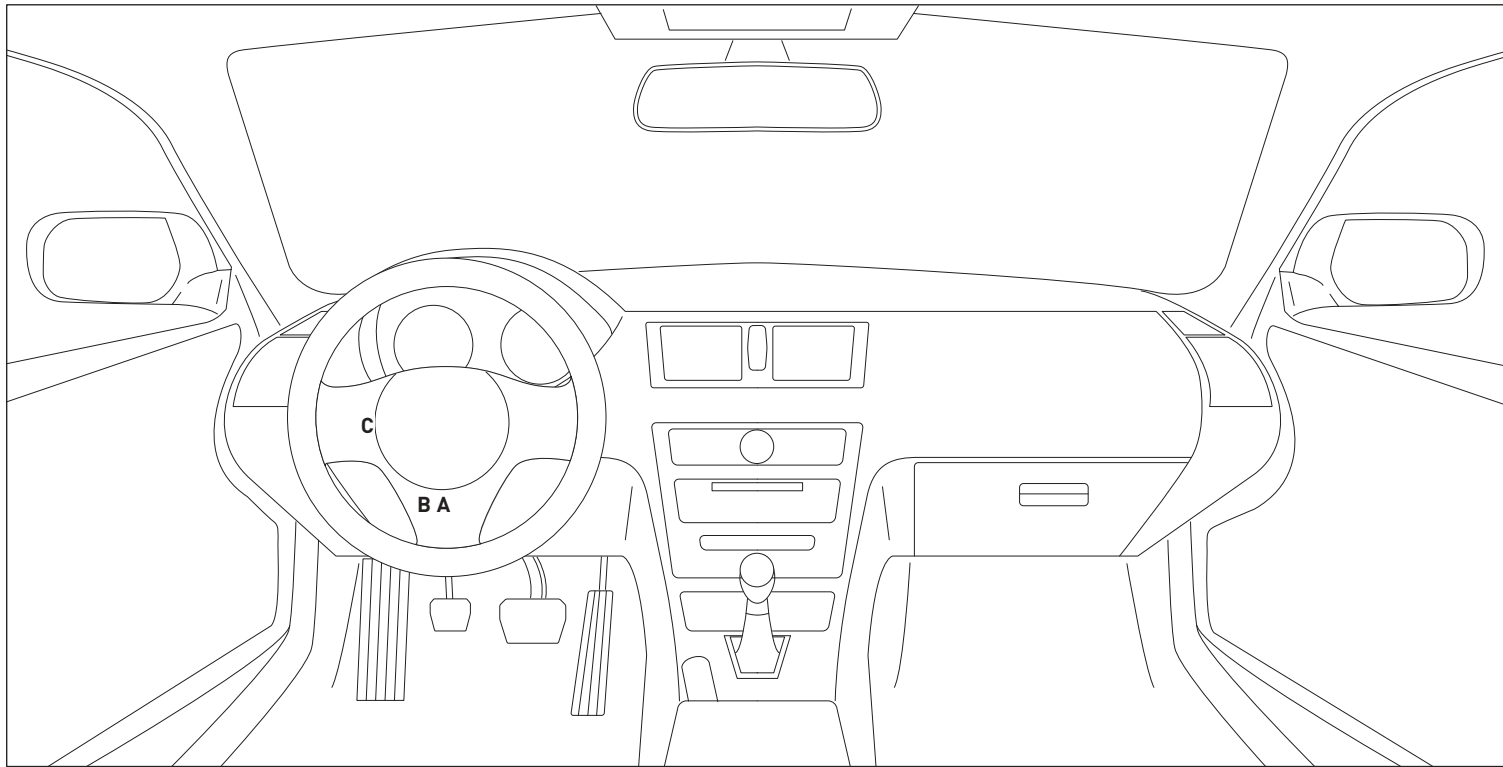

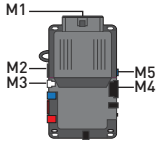

MANDATORY STEPS FOR MANUAL TRANSMISSION:
 1- DO NOT CUT THE LOOP.
 2- CONNECT THE MANUAL TRANSMISSION DIGITAL SENSOR.
 3- SEE THE PRODUCT GUIDE FOR MORE INFORMATION.

DISCONNECT BATTERY BEFORE ATTEMPTING INSTALLATION

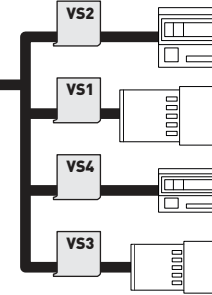
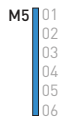

08 WHITE/PURPLE•BLACK DOT - STARTER (-) OUTPUT
 10 WHITE/BLACK•BLACK DOT - HORN (-) OUTPUT
 12 WHITE•BLACK DOT - PARKING LIGHT (-) OUTPUT

GRAY•BLUE DOT
 -GRAY/BLACK•BLUE DOT
 -GRAY/RED•BLUE DOT

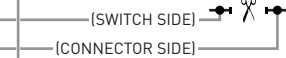

CLUTCH (-) WHITE/BLUE - 18
 HORN (-) BLUE - 01
 PARKING LIGHT 1 (-) YELLOW - 03
 PARKING LIGHT 2 (-) GREEN - 04

OPTIONAL

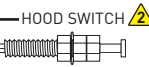

INSTALL THE SUPPLIED HOOD SWITCH IF THE VEHICLE IS NOT EQUIPPED WITH ONE. SET THE PROGRAMMING OPTION THROUGH WEBLINK AS FOLLOWS: IN "MENU #7 INPUTS CONFIGURATION", FOR "4-HOOD INPUT SOURCE" SELECT "1-ANALOG".

START STOP UNIT, UNDER STEERING COLUMN (A)

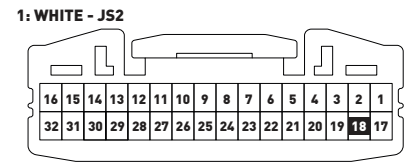
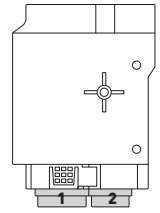
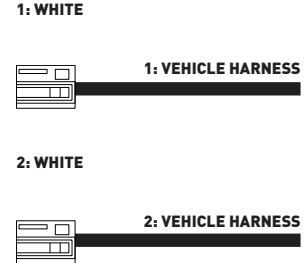

CLOCK SPRING (B)

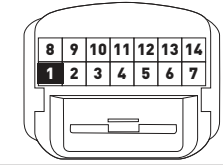

PARKING LIGHTS SWITCH, LEFT OF STEERING COLUMN (C)

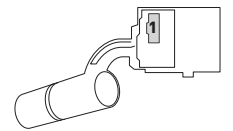
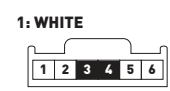

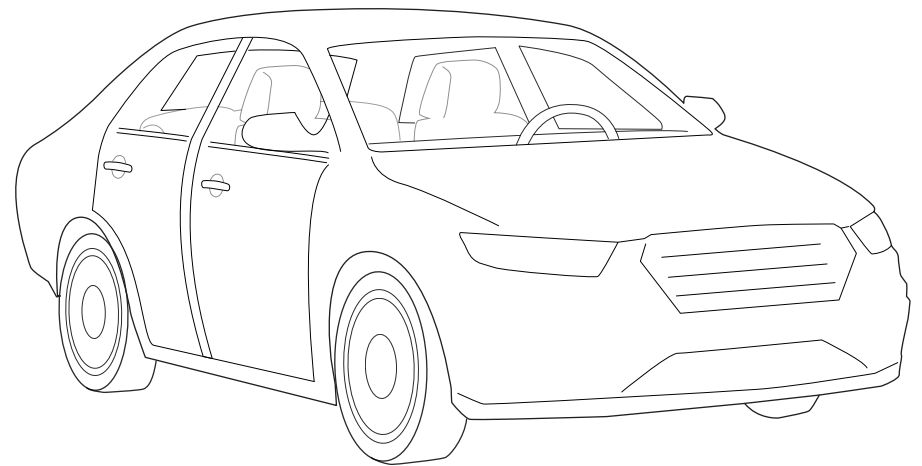
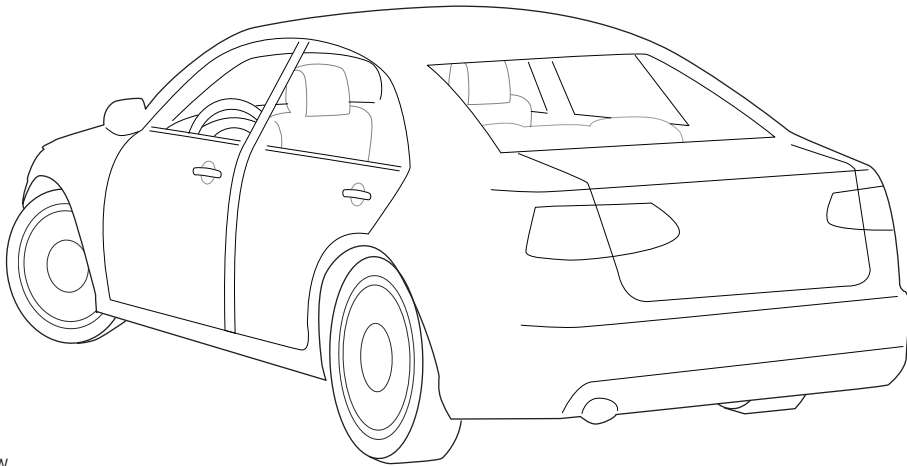
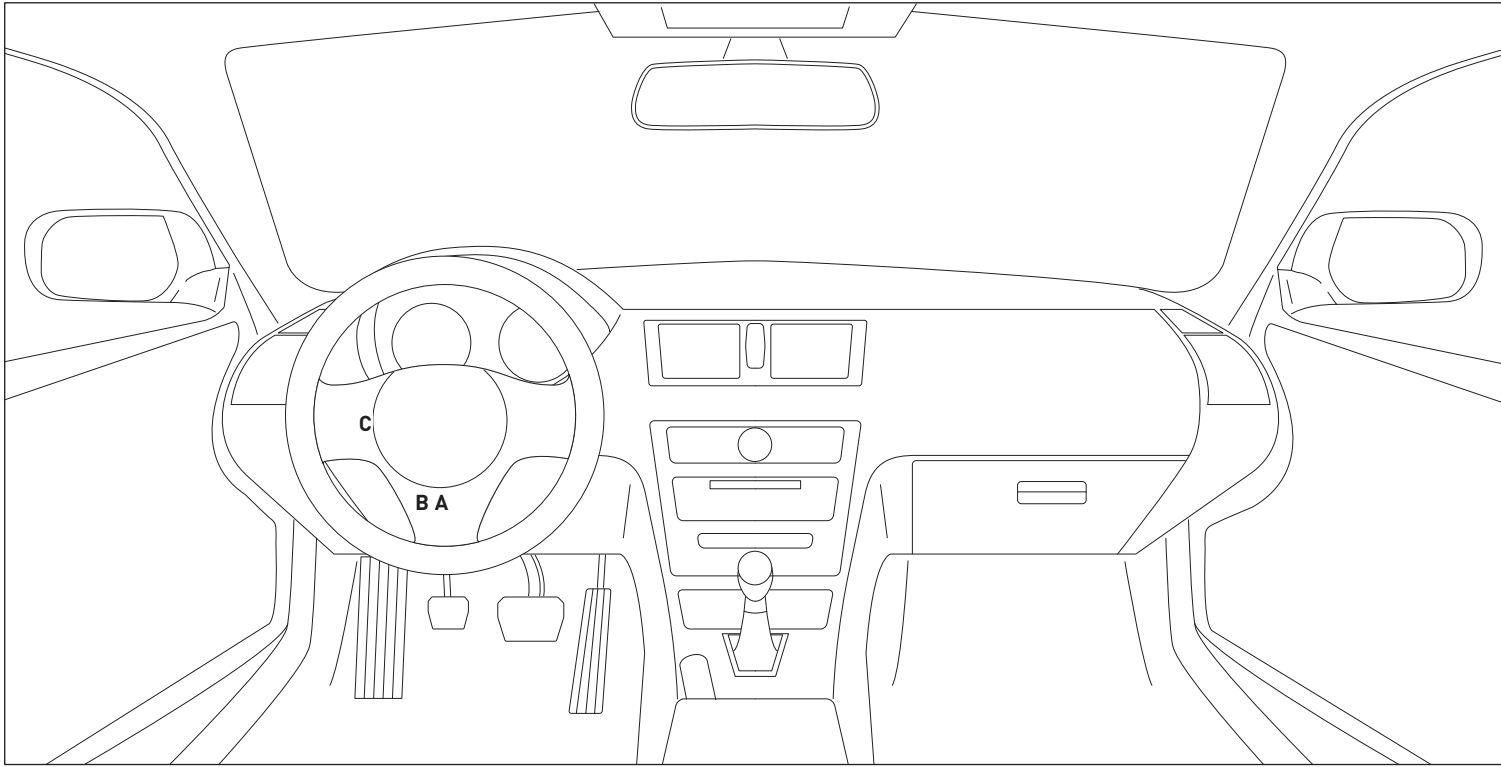

M1

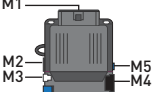

MANDATORY STEPS FOR MANUAL TRANSMISSION:
 1- DO NOT CUT THE LOOP.
 2- CONNECT THE MANUAL TRANSMISSION DIGITAL SENSOR.
 3- SEE THE PRODUCT GUIDE FOR MORE INFORMATION.

DISCONNECT BATTERY BEFORE ATTEMPTING INSTALLATION

- M1**
- 01 ORANGE
 - 02 RED
 - 03 PURPLE
 - 04 PINK/WHITE
 - 05 PINK
 - 06 WHITE
 - 07 RED
 - 08 BLACK

- M2**
- 01 GREEN•BLACK DOT
 - 02 BLUE•BLACK DOT
 - 03 RED/WHITE•BLACK DOT
 - 04 GREEN/WHITE•BLACK DOT
 - 05 GREEN/BLACK•BLACK DOT
 - 06 BLUE/WHITE•BLACK DOT
 - 07 EMPTY
 - 08 WHITE/PURPLE•BLACK DOT - STARTER (-) OUTPUT
 - 09 PURPLE/BLACK•BLACK DOT
 - 10 WHITE/BLACK•BLACK DOT - HORN (-) OUTPUT
 - 11 BROWN/BLACK•BLACK DOT
 - 12 WHITE•BLACK DOT - PARKING LIGHT 1 (-) OUTPUT

- M3**
- 01 BROWN•SILVER DOT
 - 02 BLACK/WHITE•SILVER DOT
 - 03 PURPLE•SILVER DOT
 - 04 GREEN•SILVER DOT
 - 05 PURPLE/WHITE•SILVER DOT
 - 06 WHITE/BLUE•SILVER DOT
 - 07 GRAY•SILVER DOT - HOOD STATUS (-) INPUT
 - 08 BLUE•SILVER DOT
 - 09 GRAY/BLACK•SILVER DOT
 - 10 EMPTY

- M4**
- 01 EMPTY
 - 02 EMPTY
 - 03 BROWN/RED - CANH 1
 - 04 BROWN/YELLOW - CANL 1
 - 05 BLUE/RED
 - 06 BLUE/YELLOW
 - 07 EMPTY
 - 08 ORANGE
 - 09 YELLOW
 - 10 EMPTY
 - 11 GRAY/RED - PTS (-) OUTPUT
 - 12 GRAY/YELLOW
 - 13 GREEN/RED - KEYLESS (DATA)
 - 14 ORANGE/WHITE
 - 15 BROWN - ACCESSORY (+) IN/OUT
 - 16 ORANGE/BLACK
 - 17 PINK - IGNITION (+) IN/OUT
 - 18 PURPLE - STARTER (+) OUTPUT
 - 19 RED - 12V (+) INPUT
 - 20 BLACK - GROUND (-)

- M5**
- 01 GRAY/BLACK•BLUE DOT - PARKING LIGHT 2 (-) SWITCH SIDE
 - 02 WHITE/BLACK•BLUE DOT - IGNITION (+) VEHICLE SIDE
 - 03 GRAY/RED•BLUE DOT - PARKING LIGHT 2 (-) CONNECTOR SIDE
 - 04 WHITE/RED•BLUE DOT - IGNITION (+) CONNECTOR SIDE
 - 05 GRAY•BLUE DOT
 - 06 WHITE•BLUE DOT

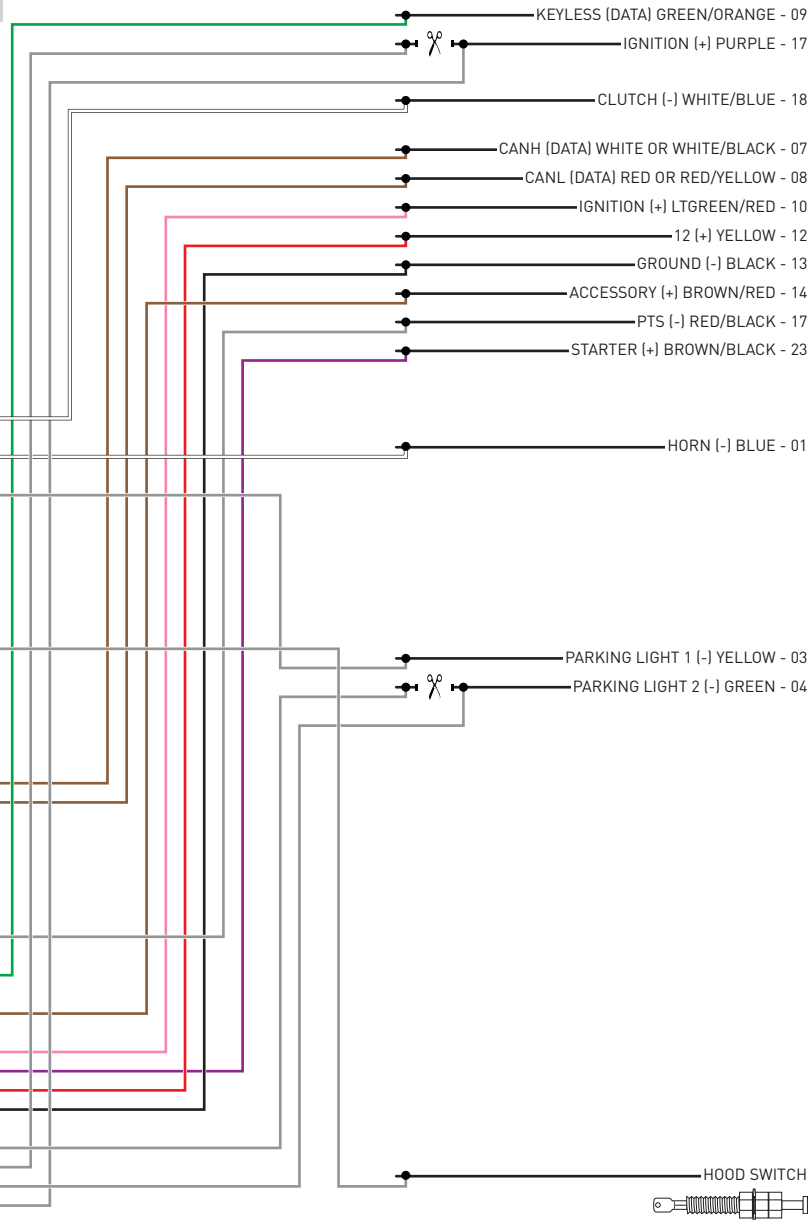

INSTALL THE SUPPLIED HOOD SWITCH IF THE VEHICLE IS NOT EQUIPPED WITH ONE SET THE PROGRAMMING OPTION THROUGH WEBLINK AS FOLLOWS:
 IN "MENU #7 INPUTS CONFIGURATION",
 FOR "4-HOOD INPUT SOURCE" SELECT "1-ANALOG".

START STOP UNIT, UNDER STEERING COLUMN (A)

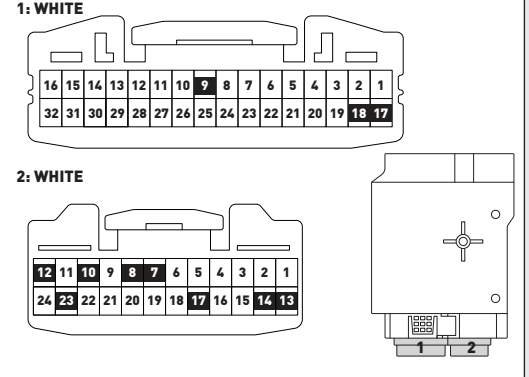

CLOCK SPRING (B)

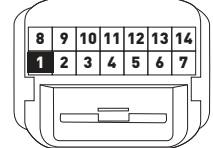

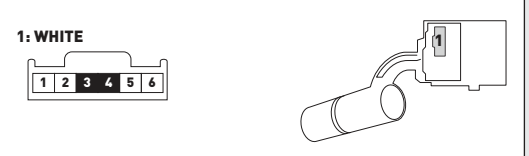

PARKING LIGHTS SWITCH, LEFT OF STEERING COLUMN (C)



>>  WARNING: All vehicle doors must be closed and locked prior to remote start sequence.

01  Set ignition to ON position.

02  Wait, LED 1 will turn solid RED to confirm that the ignition is ON.

03  Wait 10 seconds, LED 1 will flash GREEN rapidly.

04  Set ignition to OFF position.

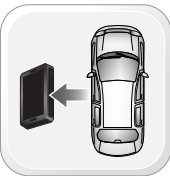
05  WARNING: Disconnect power last. Disconnect module from vehicle.

06  Connect module to computer and proceed with extended programming.

07  Connect power first. Connect module to vehicle.

08  Set ignition to ON position.

09  Wait, LED 1 will turn solid RED to confirm that the ignition is ON.

10  Wait, LED 1 will turn solid GREEN for 2 seconds.

11  Set ignition to OFF position.

>>  If vehicle is equipped with power liftgate: open and close the power liftgate with OEM keyfob.

12  START vehicle for 15 seconds.

13  Press and hold the brake pedal.

14  Press and release the module's programming button.

15  Release the brake pedal.

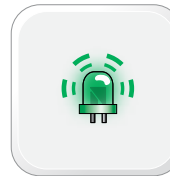
16  Wait, LED 2 will flash GREEN. Module Programming Procedure completed.

>>



All vehicle doors must be closed and locked prior to remote start sequence.

01



Time restriction. Complete steps 2 to 5 within 45 seconds.

02



Press unlock on OEM or aftermarket remote or request switch.

03



Open driver door and enter vehicle.

04



Close driver door.

05



Press and release BRAKE pedal.

06



Take over procedure completed.

>>



Failure to follow procedure will result in vehicle engine shutdown.

CHECKLIST - WITH AFTERMARKET KEYFOB

1	WARNING: Vehicle engine will start many times. Test in a well ventilated area.	9	Press the START/STOP button once [1x] on the aftermarket keyfob to shut down vehicle.
2	Close all vehicle doors, hood and trunk.		Question 7: Does the vehicle shut down?
3	Press the LOCK button once [1x] on the aftermarket keyfob.	<input type="checkbox"/>	YES: Go to next step.
	Question 1: Do the doors lock?	<input type="checkbox"/>	NO: Repeat step. If problem persists, press the brake pedal once [1x] to shut down the vehicle and call technical support.
<input type="checkbox"/>	YES: Go to next step.	10	RAP and auto light shutdown test
<input type="checkbox"/>	NO: Verify the remote programming, the RF connections and the wired door lock/unlock connections as illustrated in the wiring diagram, if applicable. Repeat the test and call technical support, if the problem persists.		Question 8: Did the radio, interior controls and headlights turn off within 60 seconds after remote start shutdown?
4	Press the UNLOCK button once [1x] on the aftermarket keyfob.	<input type="checkbox"/>	YES: Go to next step.
	Question 2: Do the doors unlock?	<input type="checkbox"/>	NO: Verify the RAP SHUTDOWN connections as illustrated in the wiring diagram. Repeat the test and call technical support if the problem persists.
<input type="checkbox"/>	YES: Go to next step.	11	Open hood.
<input type="checkbox"/>	NO: Verify the remote programming, the RF connections and the wired door lock/unlock connections as illustrated in the wiring diagram, if applicable. Repeat the test and call technical support, if the problem persists.	12	If not already installed, affix the mandatory orange warning sticker under the hood and proceed to next step.
5	Press the TRUNK release button once [1x] on the aftermarket keyfob if supported.	13	Press the START/STOP button once [1x] on the aftermarket keyfob to remote start vehicle.
	Question 3: Does the trunk or hatch open/unlock?		Question 9: Does the vehicle remote start?
<input type="checkbox"/>	YES: Close trunk or hatch and go to next step.	<input type="checkbox"/>	YES: The vehicle is not equipped with a factory hood pin. Install a mandatory aftermarket hood switch, then repeat the test.
<input type="checkbox"/>	NO: Verify the remote programming, the RF connections and the wired trunk/hatch connections as illustrated in the wiring diagram, if applicable. Repeat the test and call technical support, if the problem persists.	<input type="checkbox"/>	NO: Go to next step.
6	Press the AUX 1 button once [1x] on the aftermarket keyfob if supported.	14	Close hood.
	Question 4: Does the driver side sliding door open?	15	Enter vehicle and close the doors.
<input type="checkbox"/>	YES: Press the AUX 1 button once [1x] to close the driver sliding door and go to next step.	16	Press the START/STOP button once [1x] on the aftermarket keyfob to remote start vehicle.
<input type="checkbox"/>	NO: Verify the remote programming and the RF connections. Repeat the test and call technical support, if the problem persists.	17	Wait for the vehicle to start.
7	Press the AUX 2 button once [1x] on the aftermarket keyfob if supported.	18	Press brake pedal.
	Question 5: Does the passenger side sliding door open?		Question 10: Does the vehicle shut down?
<input type="checkbox"/>	YES: Press the AUX 2 button once [1x] to close the passenger sliding door and go to next step.	<input type="checkbox"/>	YES: Go to next step.
<input type="checkbox"/>	NO: Verify the remote programming and the RF connections. Repeat the test and call technical support, if the problem persists.	<input type="checkbox"/>	NO: The module does NOT detect the brake pedal signal. Press the START/STOP button once [1x] on the aftermarket keyfob to shut down vehicle, check connection as illustrated in the wiring diagram, if applicable, and call technical support.
8	Press the START/STOP button once [1x] on the aftermarket keyfob to remote start vehicle.	19	Exit vehicle.
	Question 6: Does the vehicle remote start?	20	Installation checklist completed.
<input type="checkbox"/>	YES: Go to next step.		
<input type="checkbox"/>	NO: Verify the remote programming, the RF connections and check the remote start error codes. Repeat the test and call technical support, if the problem persists.		

CHECKLIST - WITH OEM KEYFOB

1	WARNING: Vehicle engine will start many times. Test in a well ventilated area.
2	Close all vehicle doors, hood and trunk.
3	Press LOCK button three times [3x] rapidly on the OEM keyfob to remote start vehicle.
	Question 1: Does the vehicle remote start?
<input type="checkbox"/>	YES: Go to next step.
<input type="checkbox"/>	NO: The module doesn't detect OEM remote lock button from the vehicle communication network. Check all connections, repeat the test and call technical support, if the problem persists.
4	Press LOCK button three times [3x] rapidly on the OEM keyfob to shut down vehicle.
	Question 2: Does the vehicle shut down?
<input type="checkbox"/>	YES: Go to next step.
<input type="checkbox"/>	NO: Repeat step. If the problem persists, press on the brake pedal once [1x] to shut down the vehicle and call technical support.
5	RAP Shutdown test
	Question 3: Did the radio, interior controls, and headlights turn off within 60 seconds after remote start shutdown?
<input type="checkbox"/>	YES: Go to next step.
<input type="checkbox"/>	NO: Verify the RAP SHUTDOWN connections as illustrated in the wiring diagram. Repeat the test and call technical support, if the problem persists.
6	Open hood.
7	If not already installed, affix the mandatory orange warning sticker under the hood and proceed to next step.
8	Press LOCK button three times [3x] rapidly on the OEM keyfob to remote start vehicle.
	Question 4: Does the vehicle remote start?
<input type="checkbox"/>	YES: The vehicle is not equipped with a factory hood pin. Install a mandatory aftermarket hood switch, then repeat the test.
<input type="checkbox"/>	NO: Go to next step.
9	Close hood.
10	Enter vehicle and close the doors.
11	Press LOCK button three times [3x] rapidly on the OEM keyfob to remote start vehicle.
12	Wait for the vehicle to start.
13	Press brake pedal.
	Question 5: Does the vehicle shut down?
<input type="checkbox"/>	YES: Go to next step.
<input type="checkbox"/>	NO: The module does NOT detect the brake pedal signal. Press LOCK button three times [3x] rapidly on the OEM keyfob to shut down, check the brake connection as illustrated in the wiring diagram, if applicable, and call technical support.
14	Exit vehicle.
15	Installation checklist completed.



INSTALL GUIDE

2016-2019 MAZDA CX-3 PTS AT



DOCUMENT NUMBER

REVISION DATE

20180829

FIRMWARE

ADS-RSA-MA3-[HCX000A]

HARDWARE

HCX000A

ACCESSORIES

ATTENTION: TO COMPLETE THIS INSTALLATION SOME ACCESSORIES MAY BE REQUIRED. VISIT OUR WEBSITE TO SEE ALL THE REQUIRED ACCESSORIES FOR YOUR VEHICLE.

TERMS OF USE

Automotive Data Solutions Inc. ("ADS") products are strictly intended for installation by Certified Technicians who are employed by a registered business specialized in the installation of automotive aftermarket electronics products. Prior to beginning installation of an ADS product in a vehicle, it is the Certified Technician's responsibility to review the most current Product Guide, Install Guide and vehicle-specific notes available in Weblink®. ADS is not responsible for any damages whatsoever, including but not limited to any consequential damages, incidental damages, damages for loss of time, loss of earnings, loss of profit, commercial loss, loss of economic opportunity and the like that may or may not have resulted from the use, misuse, improper installation or operation of its products. ADS reserves itself the right to suspend any Weblink® account without notice and decline to offer technical support to non-Certified Technicians, non-compliant Certified Technicians or end users.

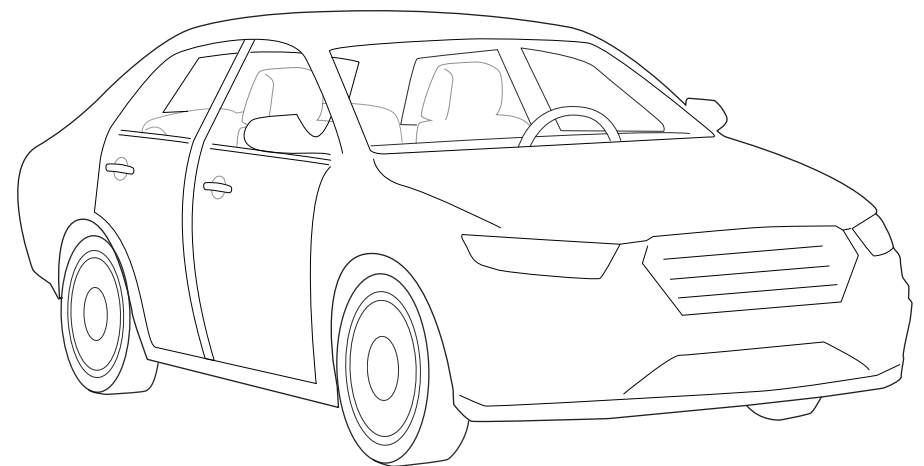
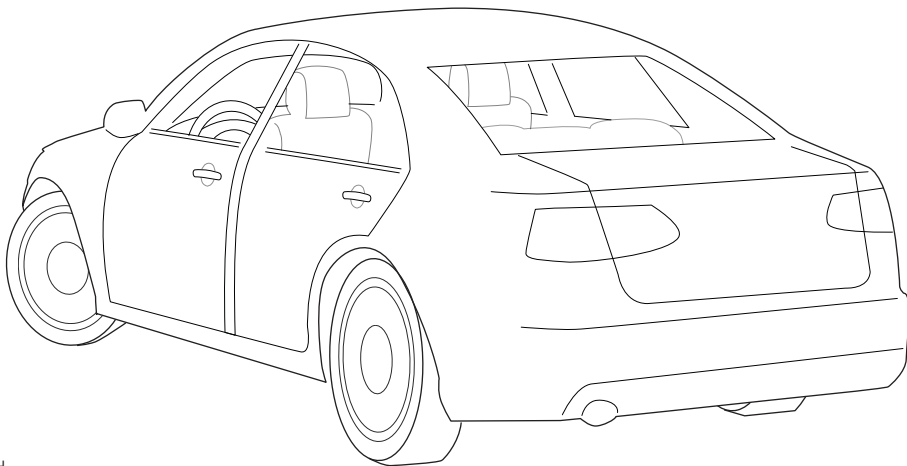
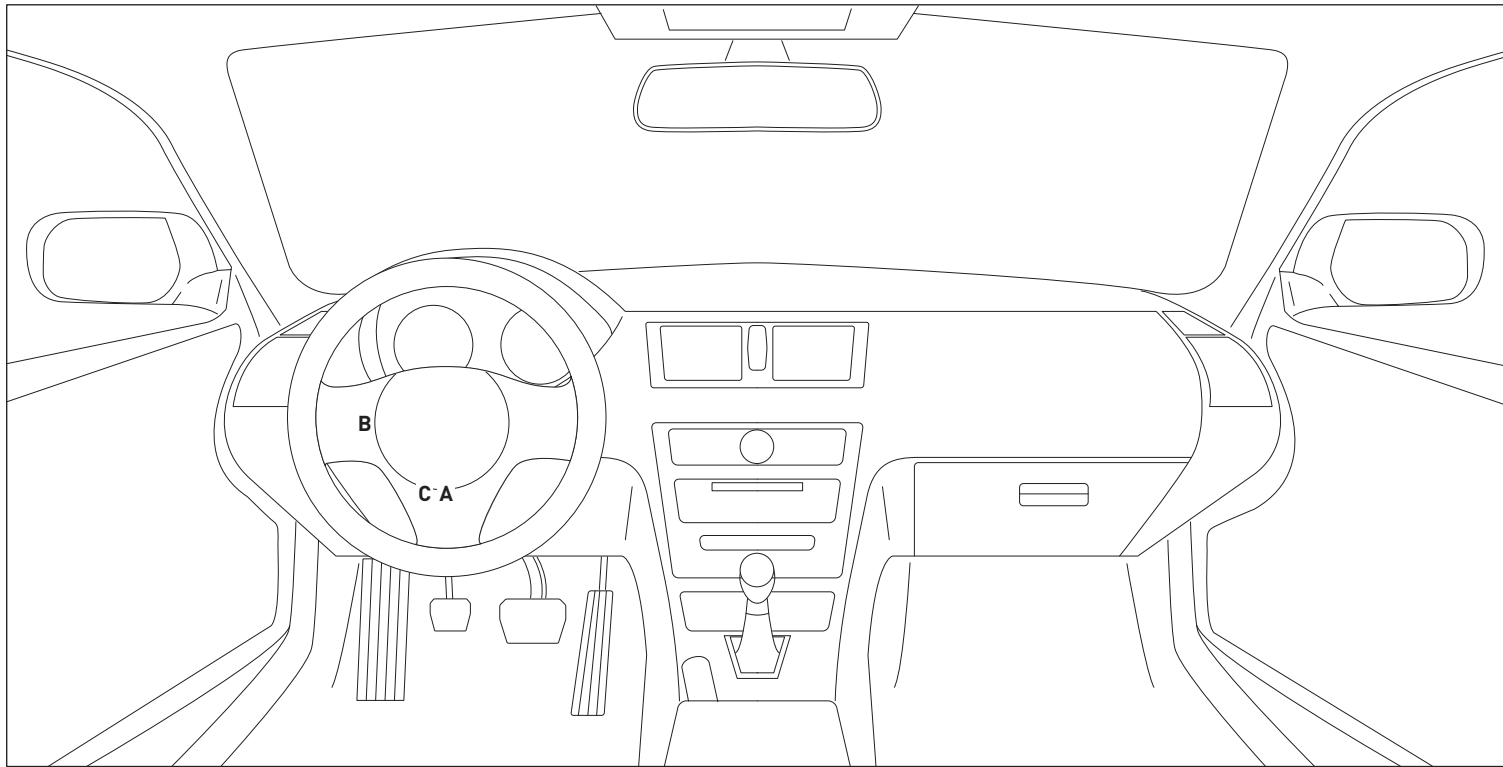

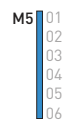
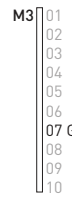
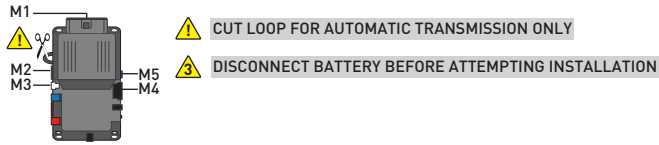

GRAY•BLUE DOT
GRAY/RED•BLUE DOT
GRAY/BLACK•BLUE DOT

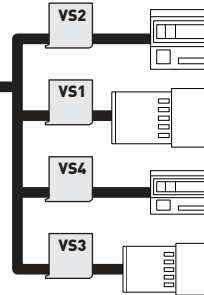

HORN (-) PINK - 01

PARKING LIGHT 1 (-) BLUE - 01
PARKING LIGHT 2 (-) BLACK - 02

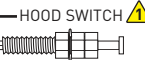

⚠ INSTALL THE SUPPLIED HOOD SWITCH IF THE VEHICLE IS NOT EQUIPPED WITH ONE
⚠ SET THE PROGRAMMING OPTION THROUGH WEBLINK AS FOLLOWS:
IN "MENU #7 INPUTS CONFIGURATION",
FOR "4-HOOD INPUT SOURCE" SELECT "1-ANALOG".

⚠ 2017+ CX-3 w/AWD : CUT AND INSULATE BOTH ENDS OF THE BROWN WIRE LOCATED IN PIN 15

START STOP UNIT, UNDER STEERING COLUMN (A)

1: WHITE

1: VEHICLE HARNESS

2: WHITE

2: VEHICLE HARNESS

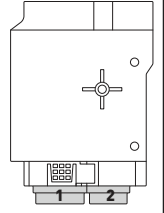

CLOCK SPRING (B)

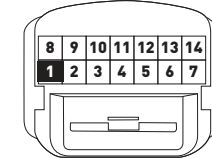

PARKING LIGHTS SWITCH, LEFT OF STEERING COLUMN (C)

1: WHITE

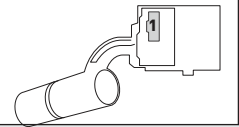
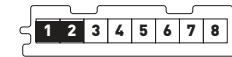

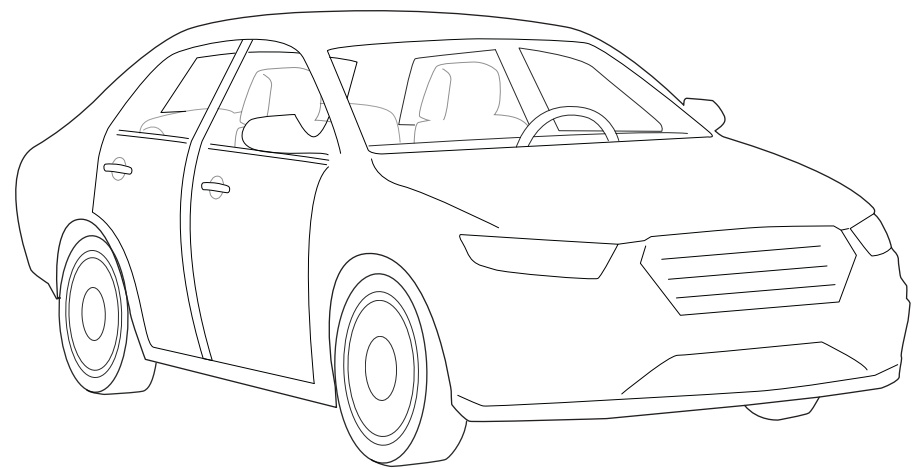
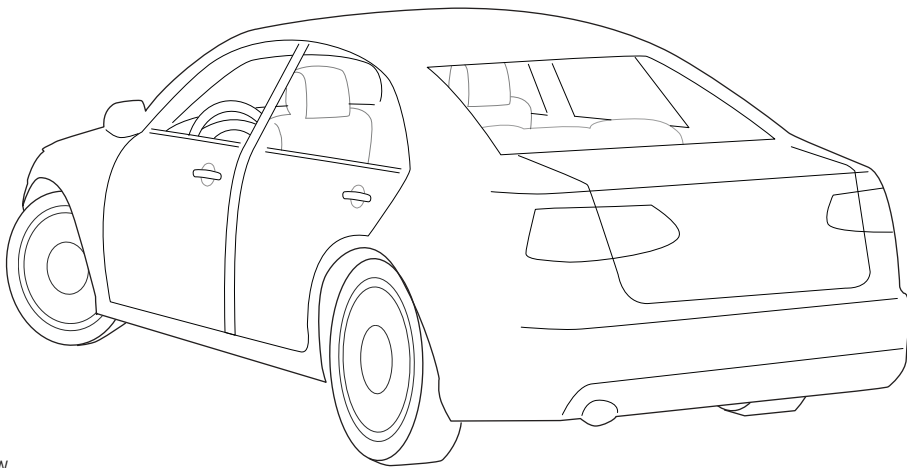
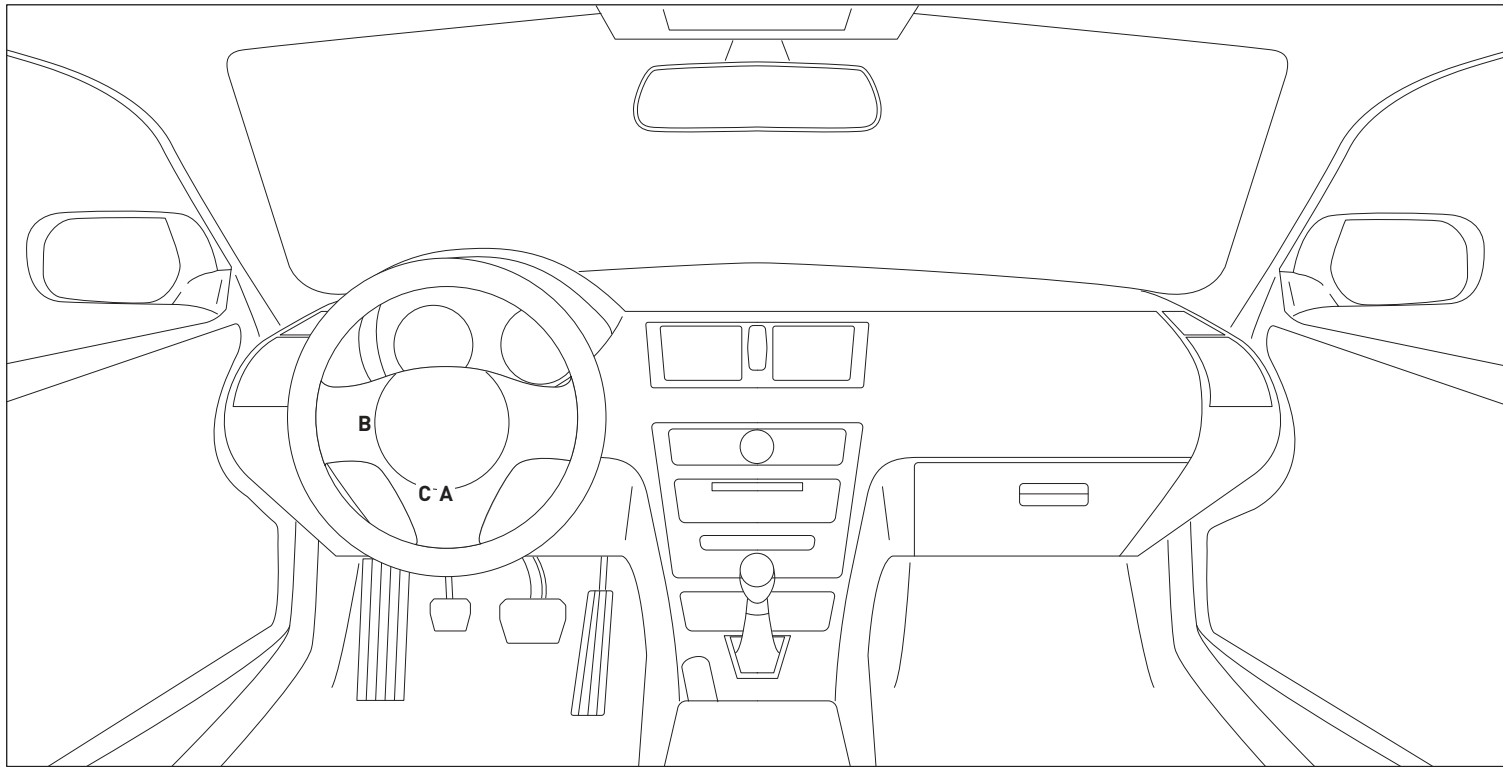

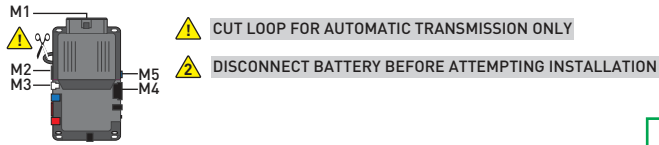

- M1**
- 01 ORANGE
- 02 RED
- 03 PURPLE
- 04 PINK/WHITE
- 05 PINK
- 06 WHITE
- 07 RED
- 08 BLACK

- M2**
- 01 GREEN•BLACK DOT
- 02 BLUE•BLACK DOT
- 03 RED/WHITE•BLACK DOT
- 04 GREEN/WHITE•BLACK DOT
- 05 GREEN/BLACK•BLACK DOT
- 06 BLUE/WHITE•BLACK DOT
- 07 EMPTY
- 08 WHITE/PURPLE•BLACK DOT
- 09 PURPLE/BLACK•BLACK DOT
- 10 WHITE/BLACK•BLACK DOT - HORN (-) OUTPUT
- 11 BROWN/BLACK•BLACK DOT
- 12 WHITE•BLACK DOT

- M3**
- 01 BROWN•SILVER DOT
- 02 BLACK/WHITE•SILVER DOT
- 03 PURPLE•SILVER DOT
- 04 GREEN•SILVER DOT
- 05 PURPLE/WHITE•SILVER DOT
- 06 WHITE/BLUE•SILVER DOT
- 07 GRAY•SILVER DOT - HOOD STATUS (-) INPUT
- 08 BLUE•SILVER DOT
- 09 GRAY/BLACK•SILVER DOT
- 10 EMPTY

- M4**
- 01 EMPTY
- 02 EMPTY
- 03 BROWN/RED - CANH 1
- 04 BROWN/YELLOW - CANL 1
- 05 BLUE/RED
- 06 BLUE/YELLOW
- 07 EMPTY
- 08 ORANGE
- 09 YELLOW
- 10 EMPTY
- 11 GRAY/RED - PTS (-) OUTPUT
- 12 GRAY/YELLOW
- 13 GREEN/RED - KEYLESS (DATA)
- 14 ORANGE/WHITE
- 15 BROWN
- 16 ORANGE/BLACK
- 17 PINK - IGNITION (+) IN/OUT
- 18 PURPLE - STARTER (+) OUTPUT
- 19 RED - 12V (+) INPUT
- 20 BLACK - GROUND (-)

- M5**
- 01 GRAY/BLACK•BLUE DOT - PARKING LIGHT 2 (-) CONNECTOR SIDE
- 02 WHITE/BLACK•BLUE DOT - IGNITION (+)
- 03 GRAY/RED•BLUE DOT - PARKING LIGHT 2 (-) SWITCH SIDE
- 04 WHITE/RED•BLUE - IGNITION (+)
- 05 GRAY•BLUE DOT - PARKING LIGHT 1 (-) OUTPUT
- 06 WHITE•BLUE

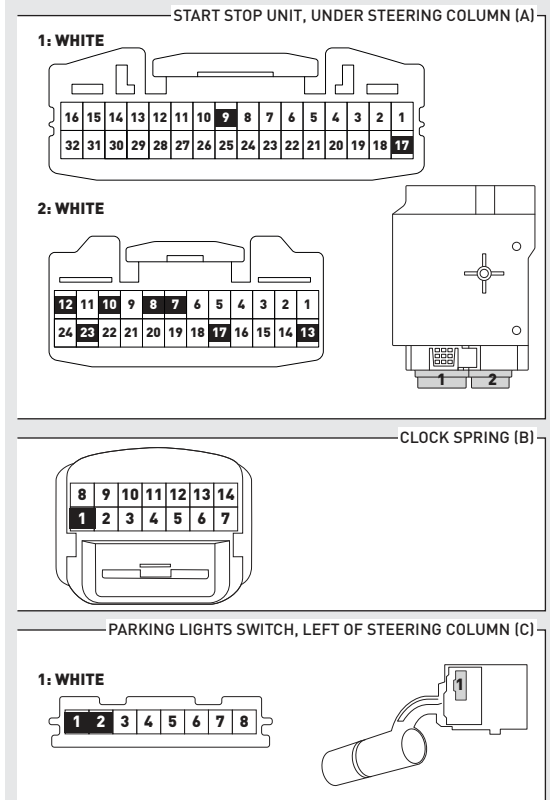
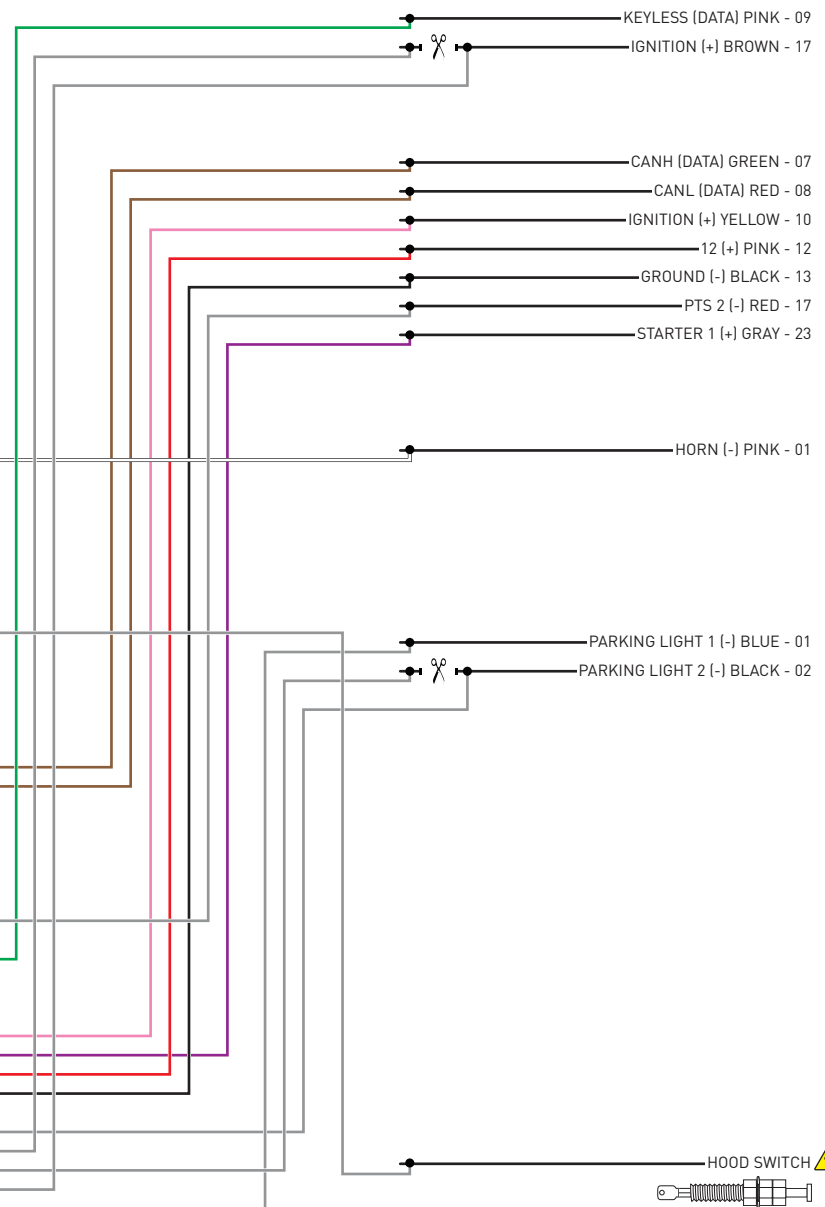

INSTALL THE SUPPLIED HOOD SWITCH IF THE VEHICLE IS NOT EQUIPPED WITH ONE SET THE PROGRAMMING OPTION THROUGH WEBLINK AS FOLLOWS:
IN "MENU #7 INPUTS CONFIGURATION", FOR "4-HOOD INPUT SOURCE" SELECT "1-ANALOG".

>>  WARNING: All vehicle doors must be closed and locked prior to remote start sequence.

01  Set ignition to ON position.

02  Wait, LED 1 will turn solid RED to confirm that the ignition is ON.

03  Wait 10 seconds, LED 1 will flash GREEN rapidly.

04  Set ignition to OFF position.

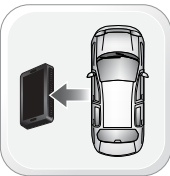
05  WARNING: Disconnect power last. Disconnect module from vehicle.

06  Connect module to computer and proceed with extended programming.

07  Connect power first. Connect module to vehicle.

08  Set ignition to ON position.

09  Wait, LED 1 will turn solid RED to confirm that the ignition is ON.

10  Wait, LED 1 will turn solid GREEN for 2 seconds.

11  Set ignition to OFF position.

>>  If vehicle is equipped with power liftgate: open and close the power liftgate with OEM keyfob.

12  START vehicle for 15 seconds.

13  Press and hold the brake pedal.

14  Press and release the module's programming button.

15  Release the brake pedal.

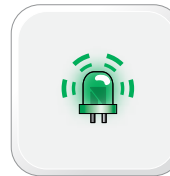
16  Wait, LED 2 will flash GREEN. Module Programming Procedure completed.

>>



All vehicle doors must be closed and locked prior to remote start sequence.

01



Time restriction. Complete steps 2 to 5 within 45 seconds.

02



Press unlock on OEM or aftermarket remote or request switch.

03



Open driver door and enter vehicle.

04



Close driver door.

05



Press and release BRAKE pedal.

06



Take over procedure completed.

>>



Failure to follow procedure will result in vehicle engine shutdown.

CHECKLIST - WITH AFTERMARKET KEYFOB

1	WARNING: Vehicle engine will start many times. Test in a well ventilated area.	9	Press the START/STOP button once [1x] on the aftermarket keyfob to shut down vehicle.
2	Close all vehicle doors, hood and trunk.		Question 7: Does the vehicle shut down?
3	Press the LOCK button once [1x] on the aftermarket keyfob.	<input type="checkbox"/>	YES: Go to next step.
	Question 1: Do the doors lock?	<input type="checkbox"/>	NO: Repeat step. If problem persists, press the brake pedal once [1x] to shut down the vehicle and call technical support.
<input type="checkbox"/>	YES: Go to next step.	10	RAP and auto light shutdown test
<input type="checkbox"/>	NO: Verify the remote programming, the RF connections and the wired door lock/unlock connections as illustrated in the wiring diagram, if applicable. Repeat the test and call technical support, if the problem persists.		Question 8: Did the radio, interior controls and headlights turn off within 60 seconds after remote start shutdown?
4	Press the UNLOCK button once [1x] on the aftermarket keyfob.	<input type="checkbox"/>	YES: Go to next step.
	Question 2: Do the doors unlock?	<input type="checkbox"/>	NO: Verify the RAP SHUTDOWN connections as illustrated in the wiring diagram. Repeat the test and call technical support if the problem persists.
<input type="checkbox"/>	YES: Go to next step.	11	Open hood.
<input type="checkbox"/>	NO: Verify the remote programming, the RF connections and the wired door lock/unlock connections as illustrated in the wiring diagram, if applicable. Repeat the test and call technical support, if the problem persists.	12	If not already installed, affix the mandatory orange warning sticker under the hood and proceed to next step.
5	Press the TRUNK release button once [1x] on the aftermarket keyfob if supported.	13	Press the START/STOP button once [1x] on the aftermarket keyfob to remote start vehicle.
	Question 3: Does the trunk or hatch open/unlock?		Question 9: Does the vehicle remote start?
<input type="checkbox"/>	YES: Close trunk or hatch and go to next step.	<input type="checkbox"/>	YES: The vehicle is not equipped with a factory hood pin. Install a mandatory aftermarket hood switch, then repeat the test.
<input type="checkbox"/>	NO: Verify the remote programming, the RF connections and the wired trunk/hatch connections as illustrated in the wiring diagram, if applicable. Repeat the test and call technical support, if the problem persists.	<input type="checkbox"/>	NO: Go to next step.
6	Press the AUX 1 button once [1x] on the aftermarket keyfob if supported.	14	Close hood.
	Question 4: Does the driver side sliding door open?	15	Enter vehicle and close the doors.
<input type="checkbox"/>	YES: Press the AUX 1 button once [1x] to close the driver sliding door and go to next step.	16	Press the START/STOP button once [1x] on the aftermarket keyfob to remote start vehicle.
<input type="checkbox"/>	NO: Verify the remote programming and the RF connections. Repeat the test and call technical support, if the problem persists.	17	Wait for the vehicle to start.
7	Press the AUX 2 button once [1x] on the aftermarket keyfob if supported.	18	Press brake pedal.
	Question 5: Does the passenger side sliding door open?		Question 10: Does the vehicle shut down?
<input type="checkbox"/>	YES: Press the AUX 2 button once [1x] to close the passenger sliding door and go to next step.	<input type="checkbox"/>	YES: Go to next step.
<input type="checkbox"/>	NO: Verify the remote programming and the RF connections. Repeat the test and call technical support, if the problem persists.	<input type="checkbox"/>	NO: The module does NOT detect the brake pedal signal. Press the START/STOP button once [1x] on the aftermarket keyfob to shut down vehicle, check connection as illustrated in the wiring diagram, if applicable, and call technical support.
8	Press the START/STOP button once [1x] on the aftermarket keyfob to remote start vehicle.	19	Exit vehicle.
	Question 6: Does the vehicle remote start?	20	Installation checklist completed.
<input type="checkbox"/>	YES: Go to next step.		
<input type="checkbox"/>	NO: Verify the remote programming, the RF connections and check the remote start error codes. Repeat the test and call technical support, if the problem persists.		

CHECKLIST - WITH OEM KEYFOB

1	WARNING: Vehicle engine will start many times. Test in a well ventilated area.
2	Close all vehicle doors, hood and trunk.
3	Press LOCK button three times [3x] rapidly on the OEM keyfob to remote start vehicle.
	Question 1: Does the vehicle remote start?
<input type="checkbox"/>	YES: Go to next step.
<input type="checkbox"/>	NO: The module doesn't detect OEM remote lock button from the vehicle communication network. Check all connections, repeat the test and call technical support, if the problem persists.
4	Press LOCK button three times [3x] rapidly on the OEM keyfob to shut down vehicle.
	Question 2: Does the vehicle shut down?
<input type="checkbox"/>	YES: Go to next step.
<input type="checkbox"/>	NO: Repeat step. If the problem persists, press on the brake pedal once [1x] to shut down the vehicle and call technical support.
5	RAP Shutdown test
	Question 3: Did the radio, interior controls, and headlights turn off within 60 seconds after remote start shutdown?
<input type="checkbox"/>	YES: Go to next step.
<input type="checkbox"/>	NO: Verify the RAP SHUTDOWN connections as illustrated in the wiring diagram. Repeat the test and call technical support, if the problem persists.
6	Open hood.
7	If not already installed, affix the mandatory orange warning sticker under the hood and proceed to next step.
8	Press LOCK button three times [3x] rapidly on the OEM keyfob to remote start vehicle.
	Question 4: Does the vehicle remote start?
<input type="checkbox"/>	YES: The vehicle is not equipped with a factory hood pin. Install a mandatory aftermarket hood switch, then repeat the test.
<input type="checkbox"/>	NO: Go to next step.
9	Close hood.
10	Enter vehicle and close the doors.
11	Press LOCK button three times [3x] rapidly on the OEM keyfob to remote start vehicle.
12	Wait for the vehicle to start.
13	Press brake pedal.
	Question 5: Does the vehicle shut down?
<input type="checkbox"/>	YES: Go to next step.
<input type="checkbox"/>	NO: The module does NOT detect the brake pedal signal. Press LOCK button three times [3x] rapidly on the OEM keyfob to shut down, check the brake connection as illustrated in the wiring diagram, if applicable, and call technical support.
14	Exit vehicle.
15	Installation checklist completed.



INSTALL GUIDE

2013-2016 MAZDA CX-5 PTS AT

DOCUMENT NUMBER

REVISION DATE

20180829

FIRMWARE

ADS-RSA-MA3-[HCX000A]

HARDWARE

HCX000A

ACCESSORIES

ATTENTION: TO COMPLETE THIS INSTALLATION SOME ACCESSORIES MAY BE REQUIRED. VISIT OUR WEBSITE TO SEE ALL THE REQUIRED ACCESSORIES FOR YOUR VEHICLE.

TERMS OF USE

Automotive Data Solutions Inc. ("ADS") products are strictly intended for installation by Certified Technicians who are employed by a registered business specialized in the installation of automotive aftermarket electronics products. Prior to beginning installation of an ADS product in a vehicle, it is the Certified Technician's responsibility to review the most current Product Guide, Install Guide and vehicle-specific notes available in Weblink®. ADS is not responsible for any damages whatsoever, including but not limited to any consequential damages, incidental damages, damages for loss of time, loss of earnings, loss of profit, commercial loss, loss of economic opportunity and the like that may or may not have resulted from the use, misuse, improper installation or operation of its products. ADS reserves itself the right to suspend any Weblink® account without notice and decline to offer technical support to non-Certified Technicians, non-compliant Certified Technicians or end users.



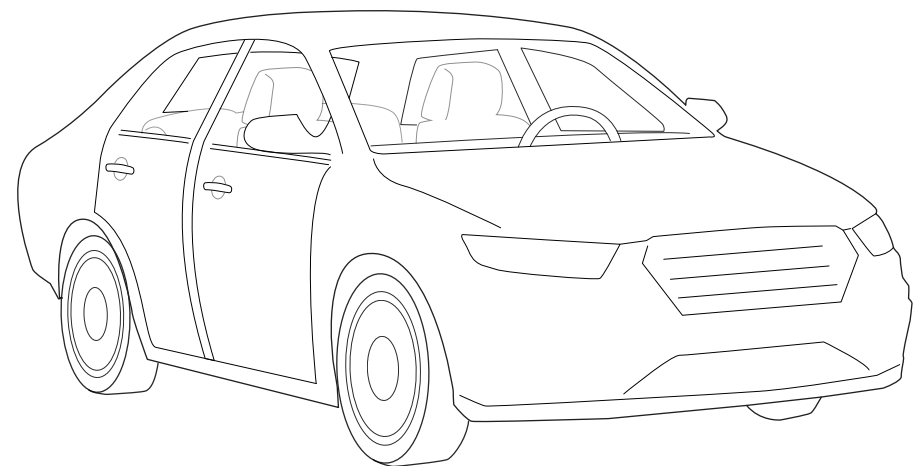
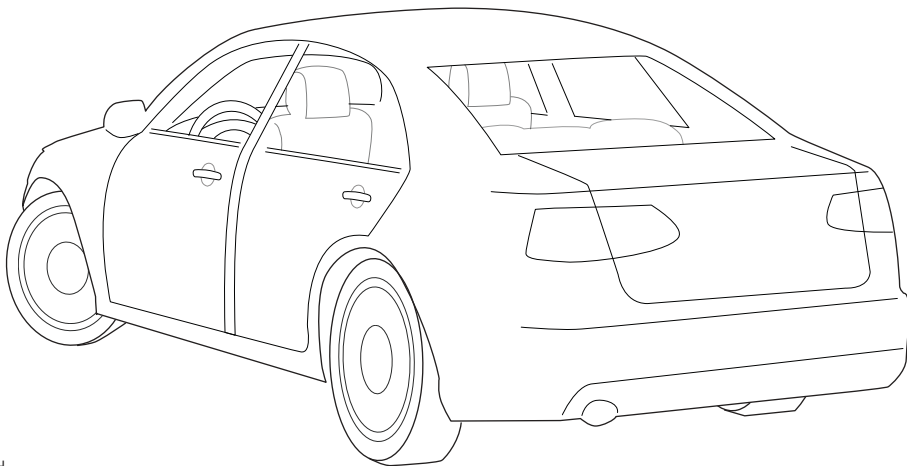
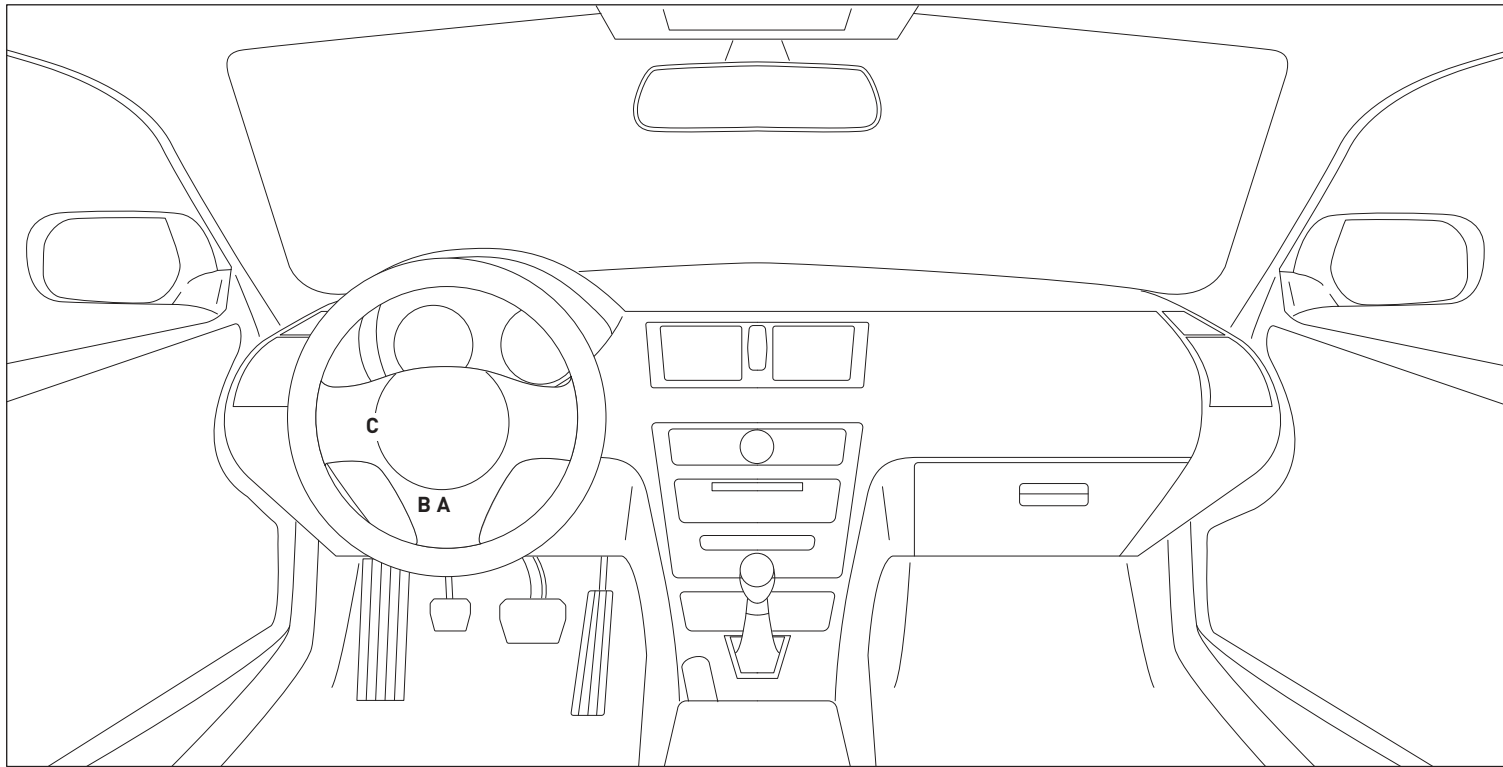

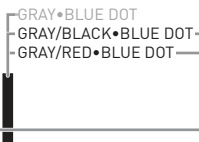
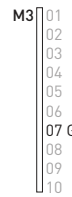
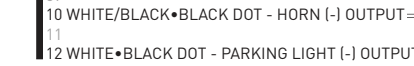
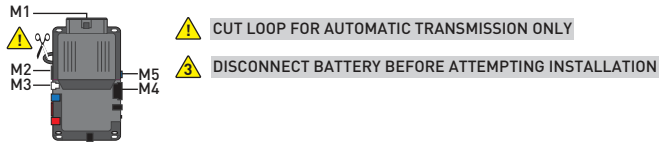

MS1

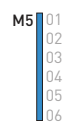

MS2

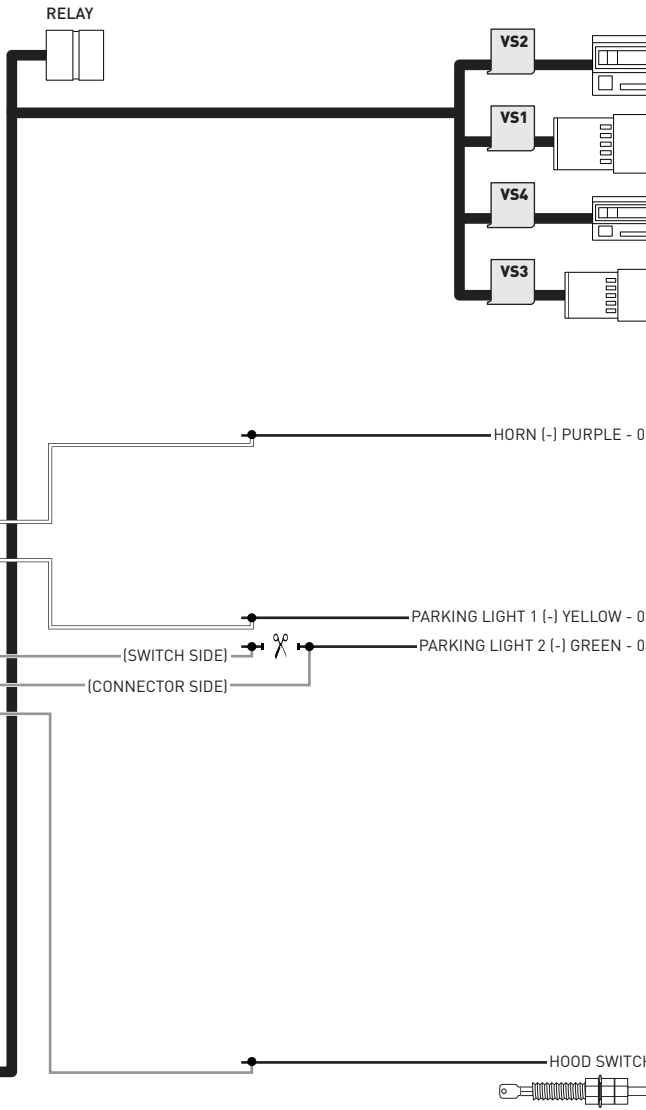

INSTALL THE SUPPLIED HOOD SWITCH IF THE VEHICLE IS NOT EQUIPPED WITH ONE
SET THE PROGRAMMING OPTION THROUGH WEBLINK AS FOLLOWS:
IN "MENU #7 INPUTS CONFIGURATION",
FOR "4-HOOD INPUT SOURCE" SELECT "1-ANALOG".

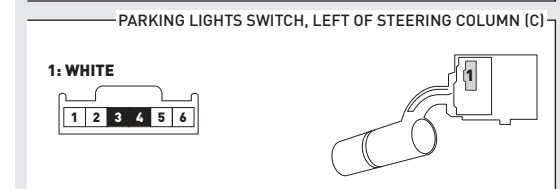
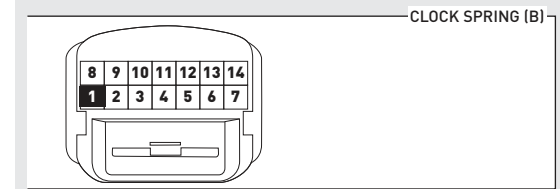
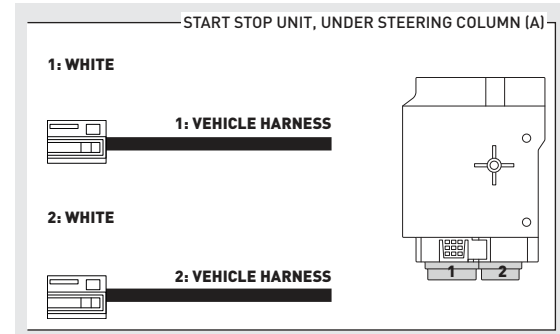

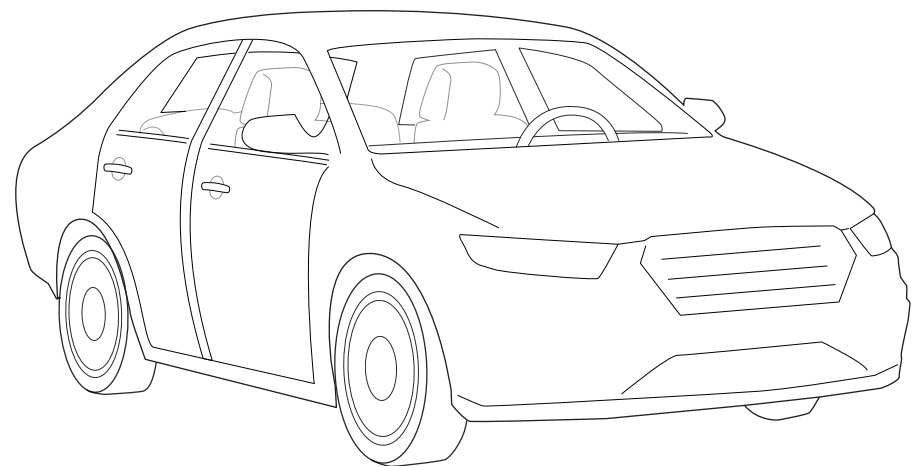
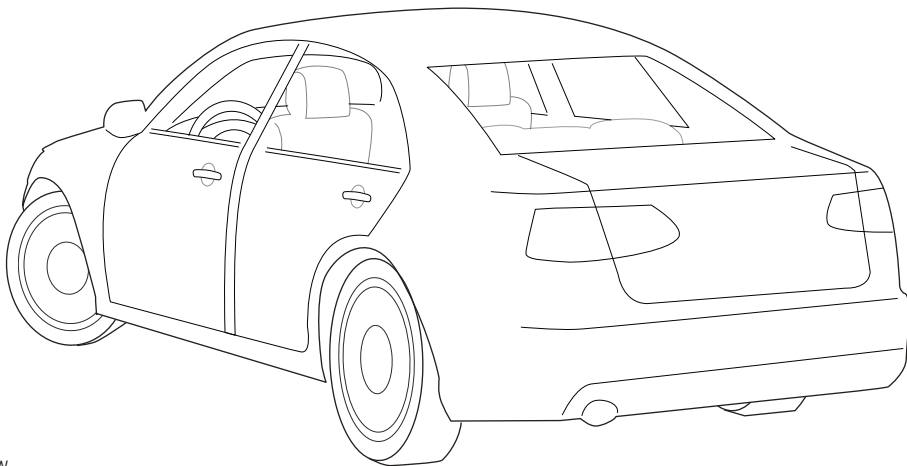
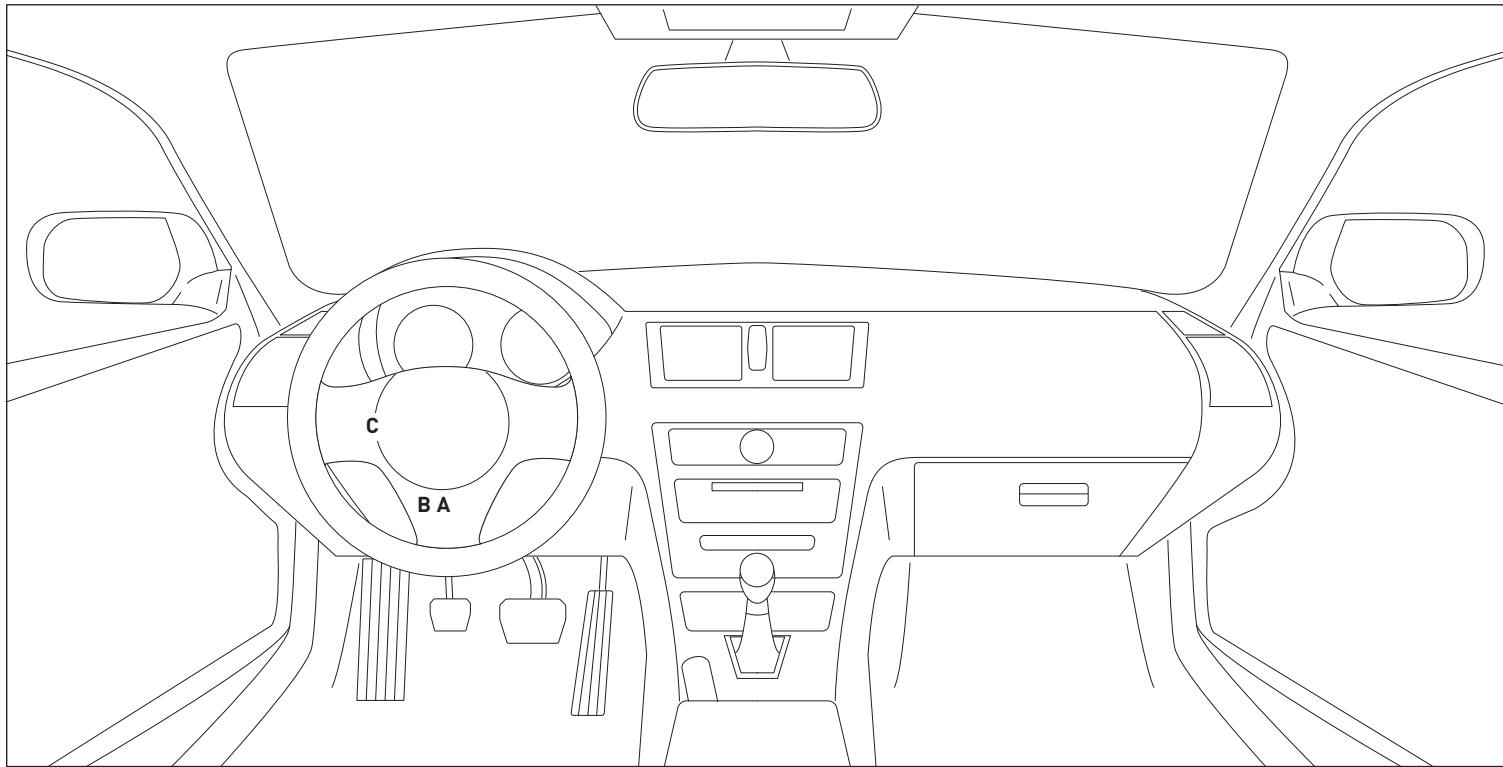

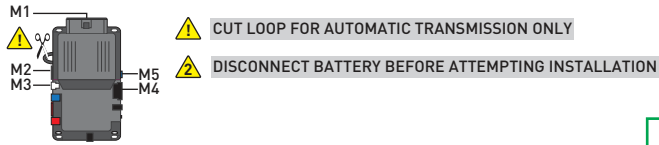

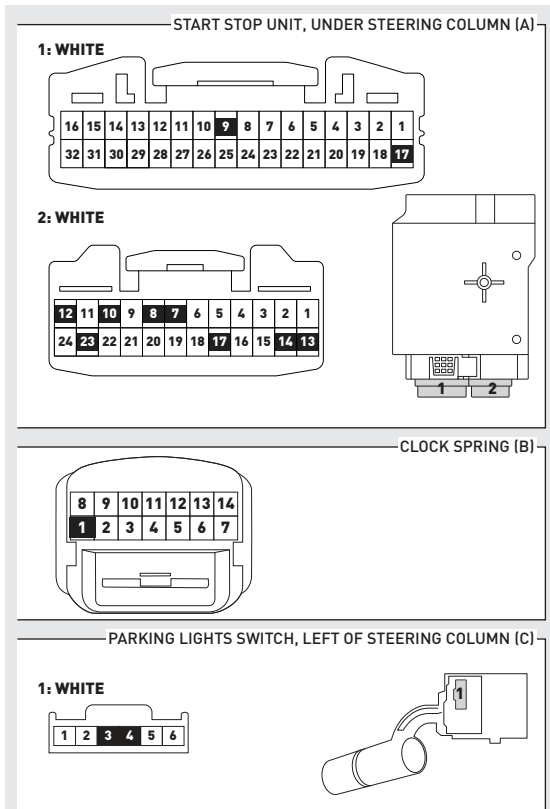
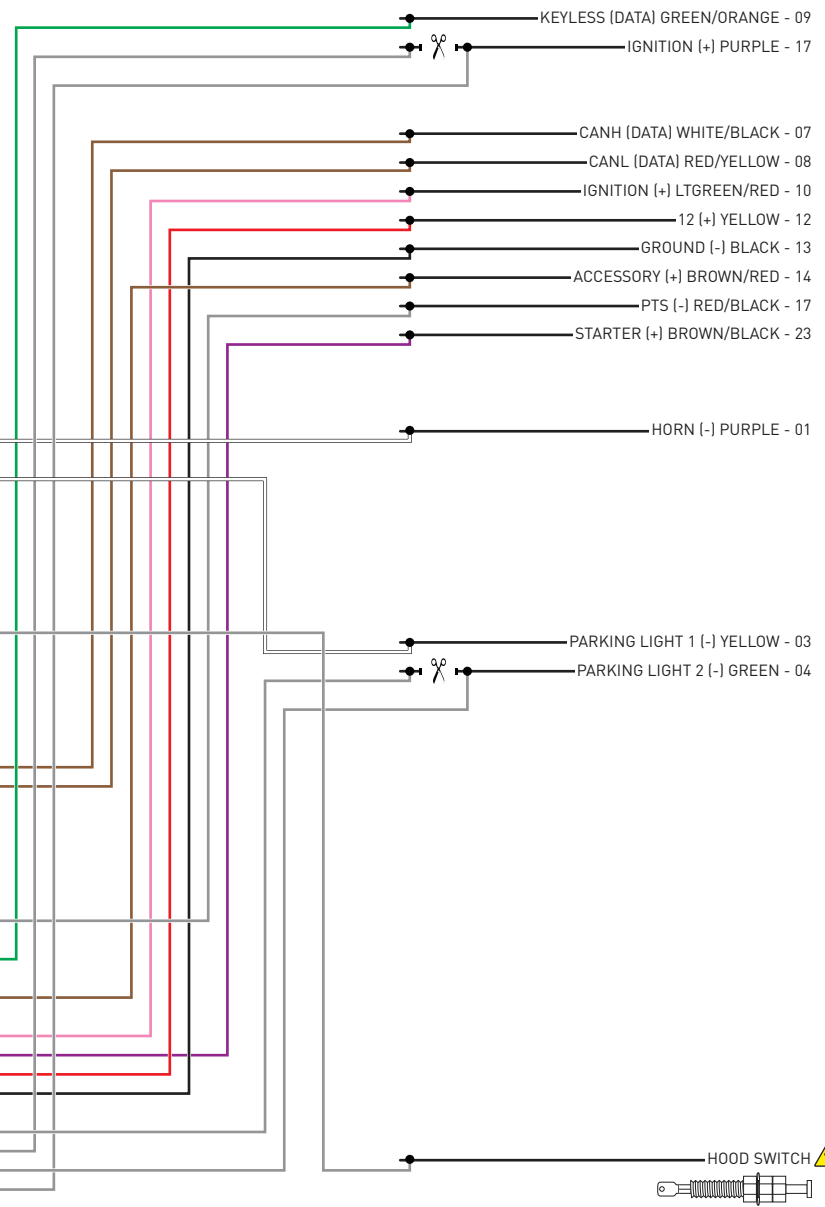

- M1**
 - 01 ORANGE
 - 02 RED
 - 03 PURPLE
 - 04 PINK/WHITE
 - 05 PINK
 - 06 WHITE
 - 07 RED
 - 08 BLACK
- M2**
 - 01 GREEN•BLACK DOT
 - 02 BLUE•BLACK DOT
 - 03 RED/WHITE•BLACK DOT
 - 04 GREEN/WHITE•BLACK DOT
 - 05 GREEN/BLACK•BLACK DOT
 - 06 BLUE/WHITE•BLACK DOT
 - 07 EMPTY
 - 08 WHITE/PURPLE•BLACK DOT
 - 09 PURPLE/BLACK•BLACK DOT
 - 10 WHITE/BLACK•BLACK DOT - HORN (-) OUTPUT
 - 11 BROWN/BLACK•BLACK DOT
 - 12 WHITE•BLACK DOT
- M3**
 - 01 BROWN•SILVER DOT
 - 02 BLACK/WHITE•SILVER DOT
 - 03 PURPLE•SILVER DOT
 - 04 GREEN•SILVER DOT
 - 05 PURPLE/WHITE•SILVER DOT
 - 06 WHITE/BLUE•SILVER DOT
 - 07 GRAY•SILVER DOT - HOOD STATUS (-) INPUT
 - 08 BLUE•SILVER DOT
 - 09 GRAY/BLACK•SILVER DOT
 - 10 EMPTY
- M4**
 - 01 EMPTY
 - 02 EMPTY
 - 03 BROWN/RED - CANH 1
 - 04 BROWN/YELLOW - CANL 1
 - 05 BLUE/RED
 - 06 BLUE/YELLOW
 - 07 EMPTY
 - 08 ORANGE
 - 09 YELLOW
 - 10 EMPTY
 - 11 GRAY/RED - PTS (-) OUTPUT
 - 12 GRAY/YELLOW
 - 13 GREEN/RED - KEYLESS DATA
 - 14 ORANGE/WHITE
 - 15 BROWN - ACCESSORY (+) IN/OUT
 - 16 ORANGE/BLACK
 - 17 PINK - IGNITION (+) IN/OUT
 - 18 PURPLE - STARTER (+) OUTPUT
 - 19 RED - 12V (+) INPUT
 - 20 BLACK - GROUND (-)
- M5**
 - 01 GRAY/BLACK•BLUE DOT - PARKING LIGHT 2 (-) SWITCH SIDE
 - 02 WHITE/BLACK•BLU DOTE - IGNITION (+)
 - 03 GRAY/RED•BLUE DOT - PARKING LIGHT 2 (-) CONNECTOR SIDE
 - 04 WHITE/RED•BLUE DOT - IGNITION (+)
 - 05 GRAY•BLUE DOT - PARKING LIGHT 1 (-) OUTPUT
 - 06 WHITE•BLUE DOT





⚠ INSTALL THE SUPPLIED HOOD SWITCH IF THE VEHICLE IS NOT EQUIPPED WITH ONE SET THE PROGRAMMING OPTION THROUGH WEBLINK AS FOLLOWS: IN "MENU #7 INPUTS CONFIGURATION", FOR "4-HOOD INPUT SOURCE" SELECT "1-ANALOG".

>>  WARNING: All vehicle doors must be closed and locked prior to remote start sequence.

01  Set ignition to ON position.

02  Wait, LED 1 will turn solid RED to confirm that the ignition is ON.

03  Wait 10 seconds, LED 1 will flash GREEN rapidly.

04  Set ignition to OFF position.

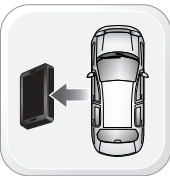
05  WARNING: Disconnect power last. Disconnect module from vehicle.

06  Connect module to computer and proceed with extended programming.

07  Connect power first. Connect module to vehicle.

08  Set ignition to ON position.

09  Wait, LED 1 will turn solid RED to confirm that the ignition is ON.

10  Wait, LED 1 will turn solid GREEN for 2 seconds.

11  Set ignition to OFF position.

>>  If vehicle is equipped with power liftgate: open and close the power liftgate with OEM keyfob.

12  START vehicle for 15 seconds.

13  Press and hold the brake pedal.

14  Press and release the module's programming button.

15  Release the brake pedal.

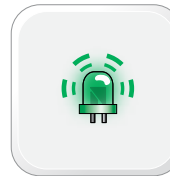
16  Wait, LED 2 will flash GREEN. Module Programming Procedure completed.

>>



All vehicle doors must be closed and locked prior to remote start sequence.

01



Time restriction. Complete steps 2 to 5 within 45 seconds.

02



Press unlock on OEM or aftermarket remote or request switch.

03



Open driver door and enter vehicle.

04



Close driver door.

05



Press and release BRAKE pedal.

06



Take over procedure completed.

>>



Failure to follow procedure will result in vehicle engine shutdown.

CHECKLIST - WITH AFTERMARKET KEYFOB

1	WARNING: Vehicle engine will start many times. Test in a well ventilated area.	9	Press the START/STOP button once [1x] on the aftermarket keyfob to shut down vehicle.
2	Close all vehicle doors, hood and trunk.		Question 7: Does the vehicle shut down?
3	Press the LOCK button once [1x] on the aftermarket keyfob.	<input type="checkbox"/>	YES: Go to next step.
	Question 1: Do the doors lock?	<input type="checkbox"/>	NO: Repeat step. If problem persists, press the brake pedal once [1x] to shut down the vehicle and call technical support.
<input type="checkbox"/>	YES: Go to next step.	10	RAP and auto light shutdown test
<input type="checkbox"/>	NO: Verify the remote programming, the RF connections and the wired door lock/unlock connections as illustrated in the wiring diagram, if applicable. Repeat the test and call technical support, if the problem persists.		Question 8: Did the radio, interior controls and headlights turn off within 60 seconds after remote start shutdown?
4	Press the UNLOCK button once [1x] on the aftermarket keyfob.	<input type="checkbox"/>	YES: Go to next step.
	Question 2: Do the doors unlock?	<input type="checkbox"/>	NO: Verify the RAP SHUTDOWN connections as illustrated in the wiring diagram. Repeat the test and call technical support if the problem persists.
<input type="checkbox"/>	YES: Go to next step.	11	Open hood.
<input type="checkbox"/>	NO: Verify the remote programming, the RF connections and the wired door lock/unlock connections as illustrated in the wiring diagram, if applicable. Repeat the test and call technical support, if the problem persists.	12	If not already installed, affix the mandatory orange warning sticker under the hood and proceed to next step.
5	Press the TRUNK release button once [1x] on the aftermarket keyfob if supported.	13	Press the START/STOP button once [1x] on the aftermarket keyfob to remote start vehicle.
	Question 3: Does the trunk or hatch open/unlock?		Question 9: Does the vehicle remote start?
<input type="checkbox"/>	YES: Close trunk or hatch and go to next step.	<input type="checkbox"/>	YES: The vehicle is not equipped with a factory hood pin. Install a mandatory aftermarket hood switch, then repeat the test.
<input type="checkbox"/>	NO: Verify the remote programming, the RF connections and the wired trunk/hatch connections as illustrated in the wiring diagram, if applicable. Repeat the test and call technical support, if the problem persists.	<input type="checkbox"/>	NO: Go to next step.
6	Press the AUX 1 button once [1x] on the aftermarket keyfob if supported.	14	Close hood.
	Question 4: Does the driver side sliding door open?	15	Enter vehicle and close the doors.
<input type="checkbox"/>	YES: Press the AUX 1 button once [1x] to close the driver sliding door and go to next step.	16	Press the START/STOP button once [1x] on the aftermarket keyfob to remote start vehicle.
<input type="checkbox"/>	NO: Verify the remote programming and the RF connections. Repeat the test and call technical support, if the problem persists.	17	Wait for the vehicle to start.
7	Press the AUX 2 button once [1x] on the aftermarket keyfob if supported.	18	Press brake pedal.
	Question 5: Does the passenger side sliding door open?		Question 10: Does the vehicle shut down?
<input type="checkbox"/>	YES: Press the AUX 2 button once [1x] to close the passenger sliding door and go to next step.	<input type="checkbox"/>	YES: Go to next step.
<input type="checkbox"/>	NO: Verify the remote programming and the RF connections. Repeat the test and call technical support, if the problem persists.	<input type="checkbox"/>	NO: The module does NOT detect the brake pedal signal. Press the START/STOP button once [1x] on the aftermarket keyfob to shut down vehicle, check connection as illustrated in the wiring diagram, if applicable, and call technical support.
8	Press the START/STOP button once [1x] on the aftermarket keyfob to remote start vehicle.	19	Exit vehicle.
	Question 6: Does the vehicle remote start?	20	Installation checklist completed.
<input type="checkbox"/>	YES: Go to next step.		
<input type="checkbox"/>	NO: Verify the remote programming, the RF connections and check the remote start error codes. Repeat the test and call technical support, if the problem persists.		

CHECKLIST - WITH OEM KEYFOB

1	WARNING: Vehicle engine will start many times. Test in a well ventilated area.
2	Close all vehicle doors, hood and trunk.
3	Press LOCK button three times [3x] rapidly on the OEM keyfob to remote start vehicle.
	Question 1: Does the vehicle remote start?
<input type="checkbox"/>	YES: Go to next step.
<input type="checkbox"/>	NO: The module doesn't detect OEM remote lock button from the vehicle communication network. Check all connections, repeat the test and call technical support, if the problem persists.
4	Press LOCK button three times [3x] rapidly on the OEM keyfob to shut down vehicle.
	Question 2: Does the vehicle shut down?
<input type="checkbox"/>	YES: Go to next step.
<input type="checkbox"/>	NO: Repeat step. If the problem persists, press on the brake pedal once [1x] to shut down the vehicle and call technical support.
5	RAP Shutdown test
	Question 3: Did the radio, interior controls, and headlights turn off within 60 seconds after remote start shutdown?
<input type="checkbox"/>	YES: Go to next step.
<input type="checkbox"/>	NO: Verify the RAP SHUTDOWN connections as illustrated in the wiring diagram. Repeat the test and call technical support, if the problem persists.
6	Open hood.
7	If not already installed, affix the mandatory orange warning sticker under the hood and proceed to next step.
8	Press LOCK button three times [3x] rapidly on the OEM keyfob to remote start vehicle.
	Question 4: Does the vehicle remote start?
<input type="checkbox"/>	YES: The vehicle is not equipped with a factory hood pin. Install a mandatory aftermarket hood switch, then repeat the test.
<input type="checkbox"/>	NO: Go to next step.
9	Close hood.
10	Enter vehicle and close the doors.
11	Press LOCK button three times [3x] rapidly on the OEM keyfob to remote start vehicle.
12	Wait for the vehicle to start.
13	Press brake pedal.
	Question 5: Does the vehicle shut down?
<input type="checkbox"/>	YES: Go to next step.
<input type="checkbox"/>	NO: The module does NOT detect the brake pedal signal. Press LOCK button three times [3x] rapidly on the OEM keyfob to shut down, check the brake connection as illustrated in the wiring diagram, if applicable, and call technical support.
14	Exit vehicle.
15	Installation checklist completed.



INSTALL GUIDE

2013-2016 MAZDA CX-5 PTS MT

DOCUMENT NUMBER

REVISION DATE

20180829

FIRMWARE

ADS-RSA-MA3-[HCX000A]

HARDWARE

HCX000A

ACCESSORIES

ATTENTION: TO COMPLETE THIS INSTALLATION SOME ACCESSORIES MAY BE REQUIRED. VISIT OUR WEBSITE TO SEE ALL THE REQUIRED ACCESSORIES FOR YOUR VEHICLE.

TERMS OF USE

Automotive Data Solutions Inc. ("ADS") products are strictly intended for installation by Certified Technicians who are employed by a registered business specialized in the installation of automotive aftermarket electronics products. Prior to beginning installation of an ADS product in a vehicle, it is the Certified Technician's responsibility to review the most current Product Guide, Install Guide and vehicle-specific notes available in Weblink®. ADS is not responsible for any damages whatsoever, including but not limited to any consequential damages, incidental damages, damages for loss of time, loss of earnings, loss of profit, commercial loss, loss of economic opportunity and the like that may or may not have resulted from the use, misuse, improper installation or operation of its products. ADS reserves itself the right to suspend any Weblink® account without notice and decline to offer technical support to non-Certified Technicians, non-compliant Certified Technicians or end users.



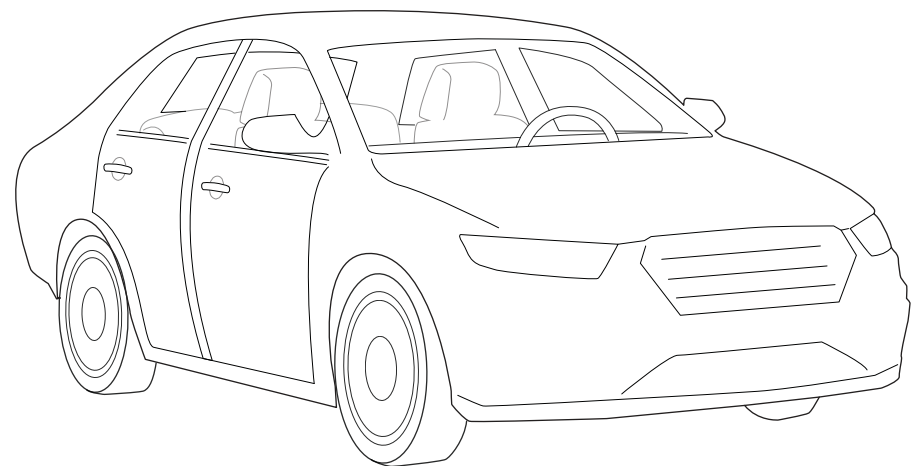
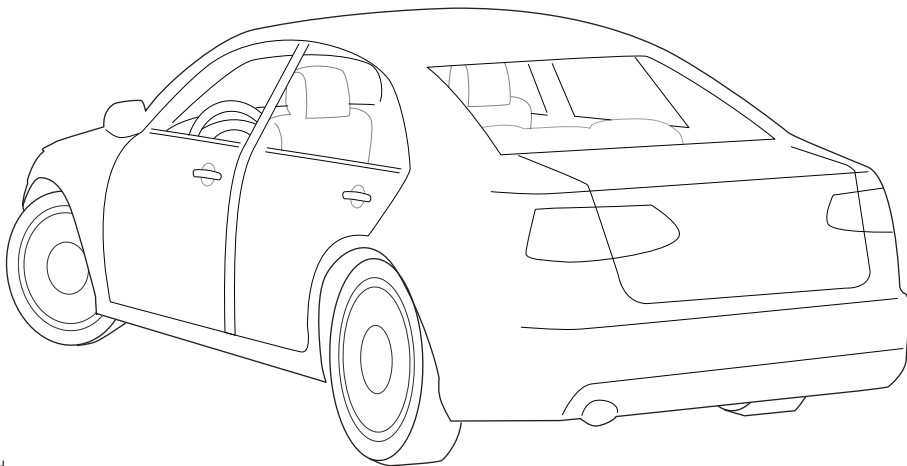
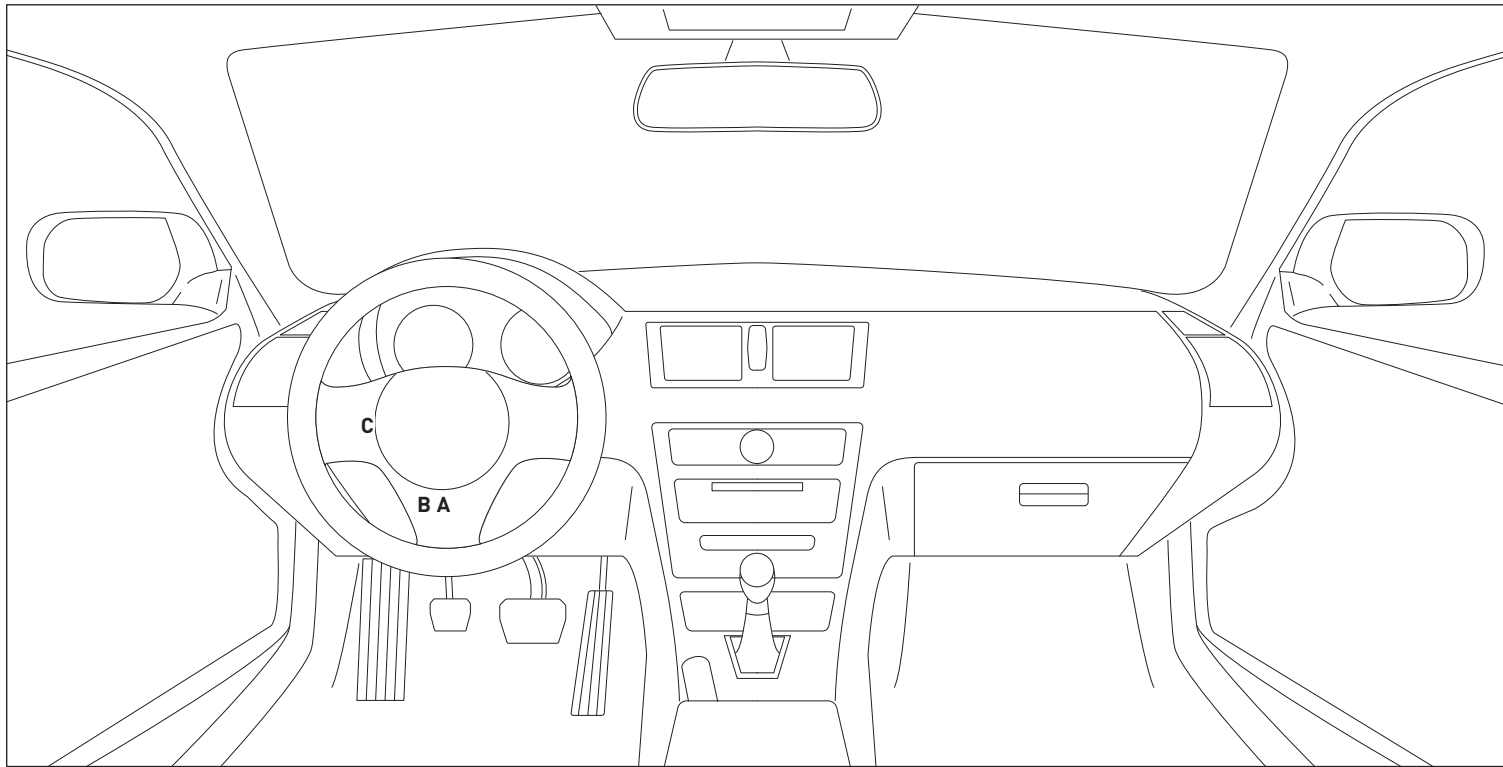

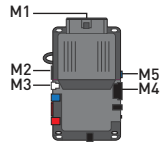

MANDATORY STEPS FOR MANUAL TRANSMISSION:
 1- DO NOT CUT THE LOOP.
 2- CONNECT THE MANUAL TRANSMISSION DIGITAL SENSOR.
 3- SEE THE PRODUCT GUIDE FOR MORE INFORMATION.

⚠️ DISCONNECT BATTERY BEFORE ATTEMPTING INSTALLATION

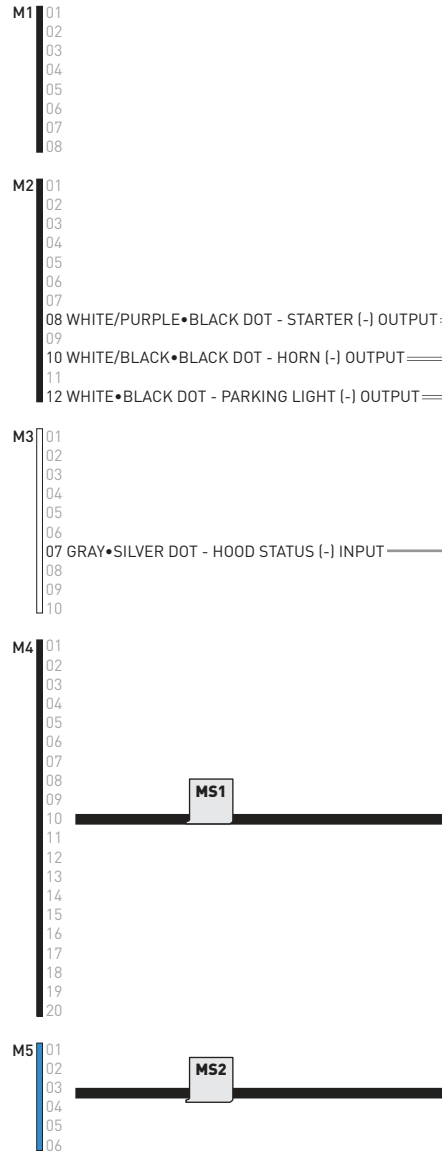

GRAY•BLUE DOT
 -GRAY/BLACK•BLUE DOT
 -GRAY/RED•BLUE DOT

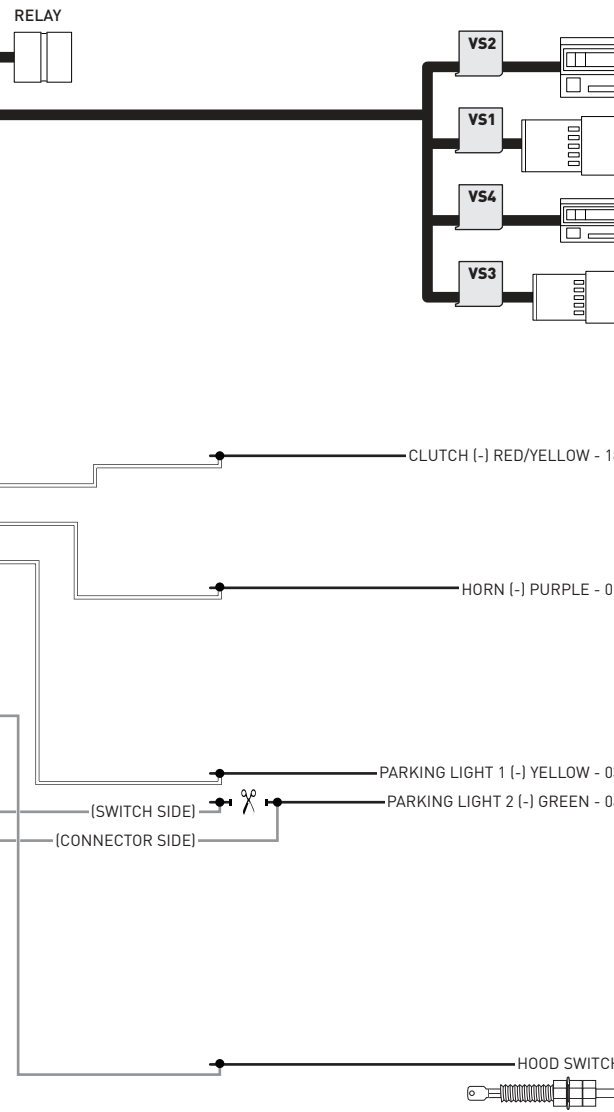

⚠️ INSTALL THE SUPPLIED HOOD SWITCH IF THE VEHICLE IS NOT EQUIPPED WITH ONE SET THE PROGRAMMING OPTION THROUGH WEBLINK AS FOLLOWS: IN "MENU #7 INPUTS CONFIGURATION", FOR "4-HOOD INPUT SOURCE" SELECT "1-ANALOG".

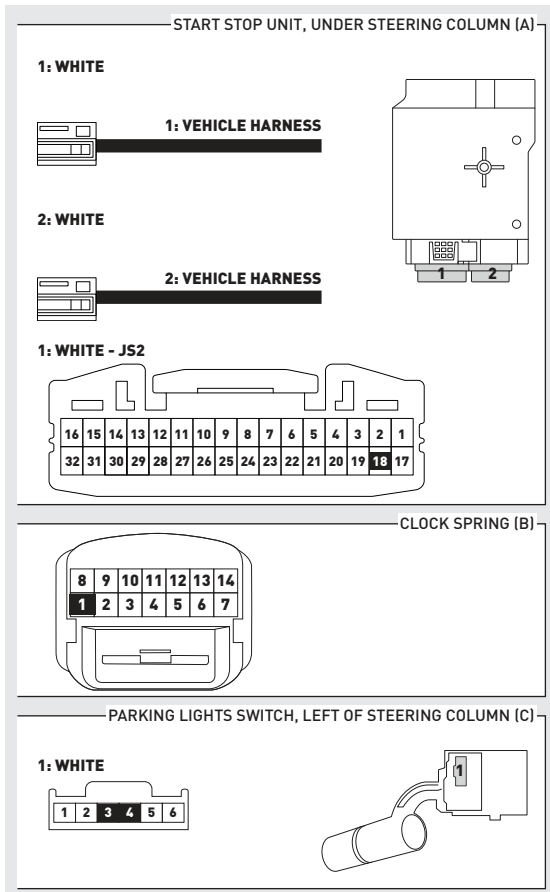

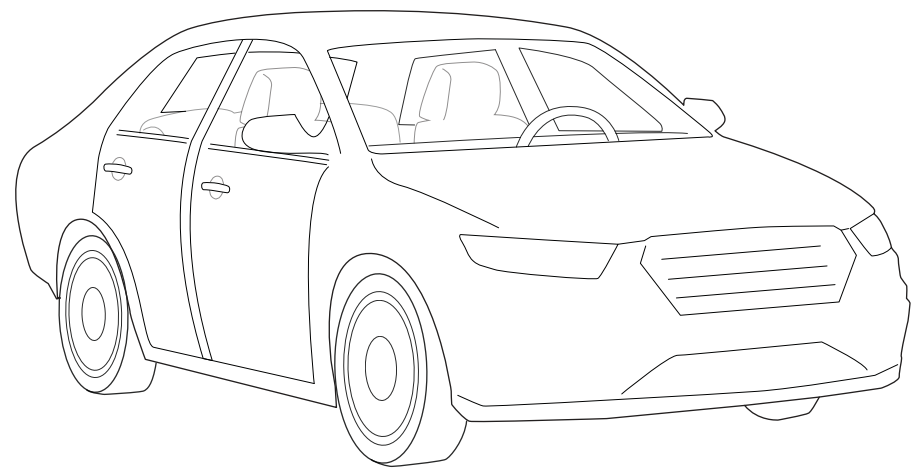
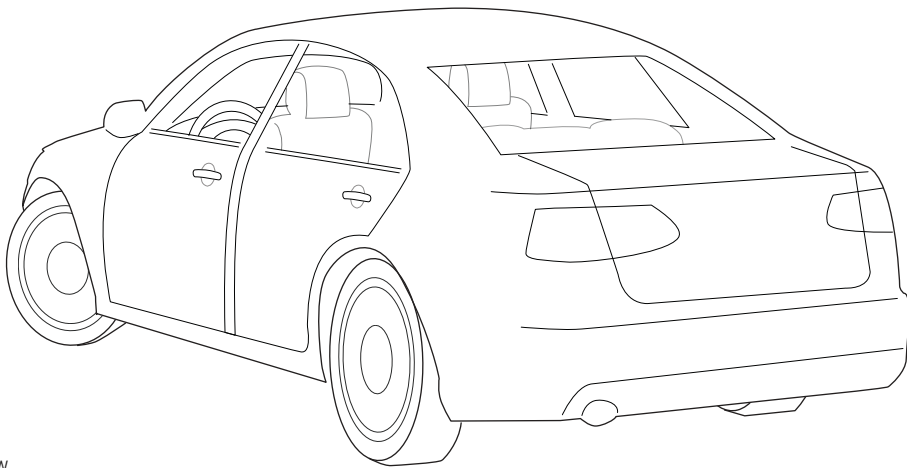
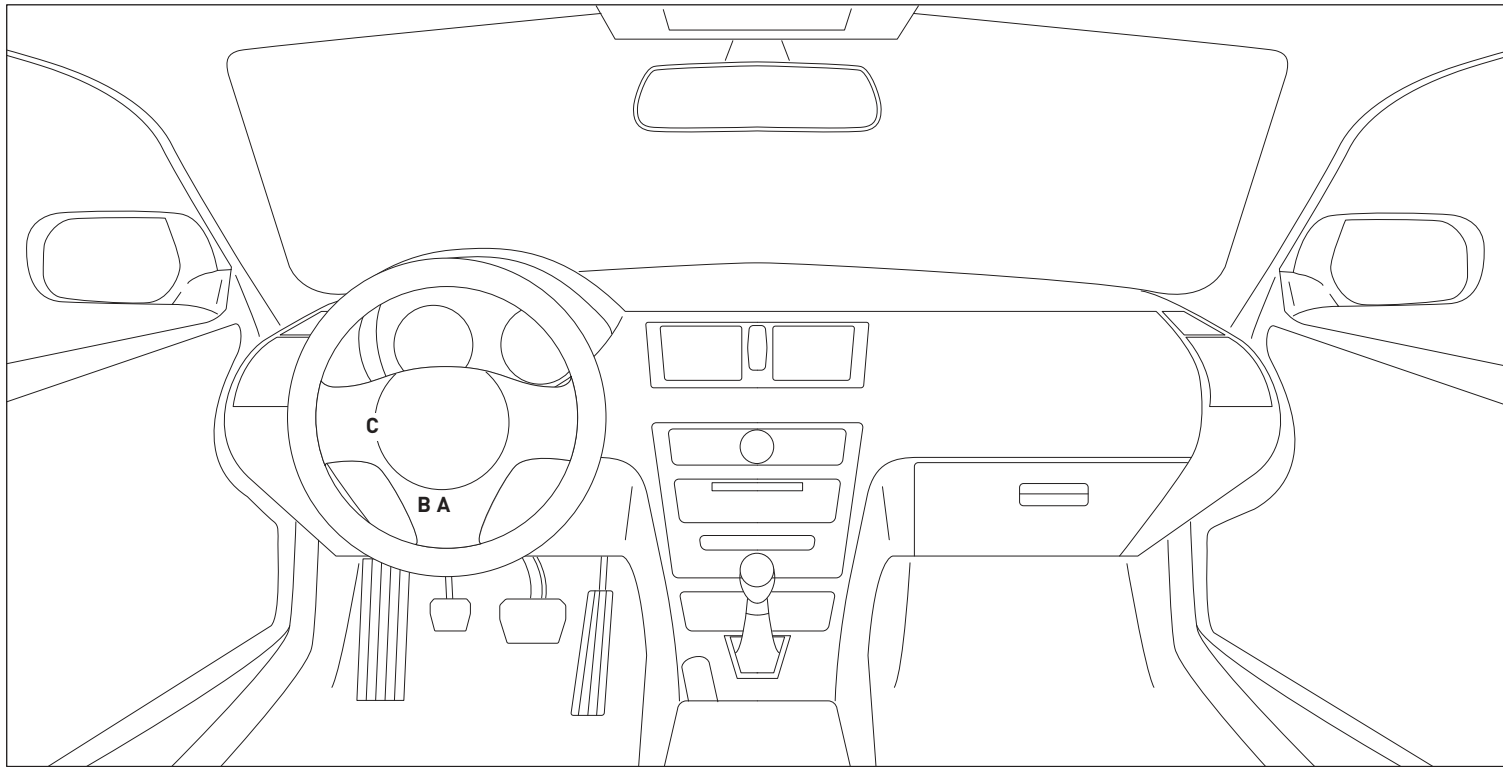

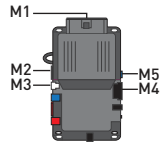

MANDATORY STEPS FOR MANUAL TRANSMISSION:
 1- DO NOT CUT THE LOOP.
 2- CONNECT THE MANUAL TRANSMISSION DIGITAL SENSOR.
 3- SEE THE PRODUCT GUIDE FOR MORE INFORMATION.

DISCONNECT BATTERY BEFORE ATTEMPTING INSTALLATION

- M1**
 - 01 ORANGE
 - 02 RED
 - 03 PURPLE
 - 04 PINK/WHITE
 - 05 PINK
 - 06 WHITE
 - 07 RED
 - 08 BLACK
- M2**
 - 01 GREEN•BLACK DOT
 - 02 BLUE•BLACK DOT
 - 03 RED/WHITE•BLACK DOT
 - 04 GREEN/WHITE•BLACK DOT
 - 05 GREEN/BLACK•BLACK DOT
 - 06 BLUE/WHITE•BLACK DOT
 - 07 EMPTY
 - 08 WHITE/PURPLE•BLACK DOT - STARTER (-) OUTPUT
 - 09 PURPLE/BLACK•BLACK DOT
 - 10 WHITE/BLACK•BLACK DOT - HORN (-) OUTPUT
 - 11 BROWN/BLACK•BLACK DOT
 - 12 WHITE•BLACK DOT - PARKING LIGHT (-) OUTPUT
- M3**
 - 01 BROWN•SILVER DOT
 - 02 BLACK/WHITE•SILVER DOT
 - 03 PURPLE•SILVER DOT
 - 04 GREEN•SILVER DOT
 - 05 PURPLE/WHITE•SILVER DOT
 - 06 WHITE/BLUE•SILVER DOT
 - 07 GRAY•SILVER DOT - HOOD STATUS (-) INPUT
 - 08 BLUE•SILVER DOT
 - 09 GRAY/BLACK•SILVER DOT
 - 10 EMPTY
- M4**
 - 01 EMPTY
 - 02 EMPTY
 - 03 BROWN/RED - CANH 1
 - 04 BROWN/YELLOW - CANL 1
 - 05 BLUE/RED
 - 06 BLUE/YELLOW
 - 07 EMPTY
 - 08 ORANGE
 - 09 YELLOW
 - 10 EMPTY
 - 11 GRAY/RED - PTS (-) OUTPUT
 - 12 GRAY/YELLOW
 - 13 GREEN/RED - KEYLESS DATA
 - 14 ORANGE/WHITE
 - 15 BROWN - ACCESSORY (+) IN/OUT
 - 16 ORANGE/BLACK
 - 17 PINK - IGNITION (+) IN/OUT
 - 18 PURPLE - STARTER (+) OUTPUT
 - 19 RED - 12V (+) INPUT
 - 20 BLACK - GROUND (-)
- M5**
 - 01 GRAY/BLACK•BLUE DOT - PARKING LIGHT 2 (-) SWITCH SIDE
 - 02 WHITE/BLACK•BLU DOTE - IGNITION (+) VEHICLE SIDE
 - 03 GRAY/RED•BLUE DOT - PARKING LIGHT 2 (-) CONNECTOR SIDE
 - 04 WHITE/RED•BLUE DOT - IGNITION (+) CONNECTOR SIDE
 - 05 GRAY•BLUE DOT
 - 06 WHITE•BLUE DOT

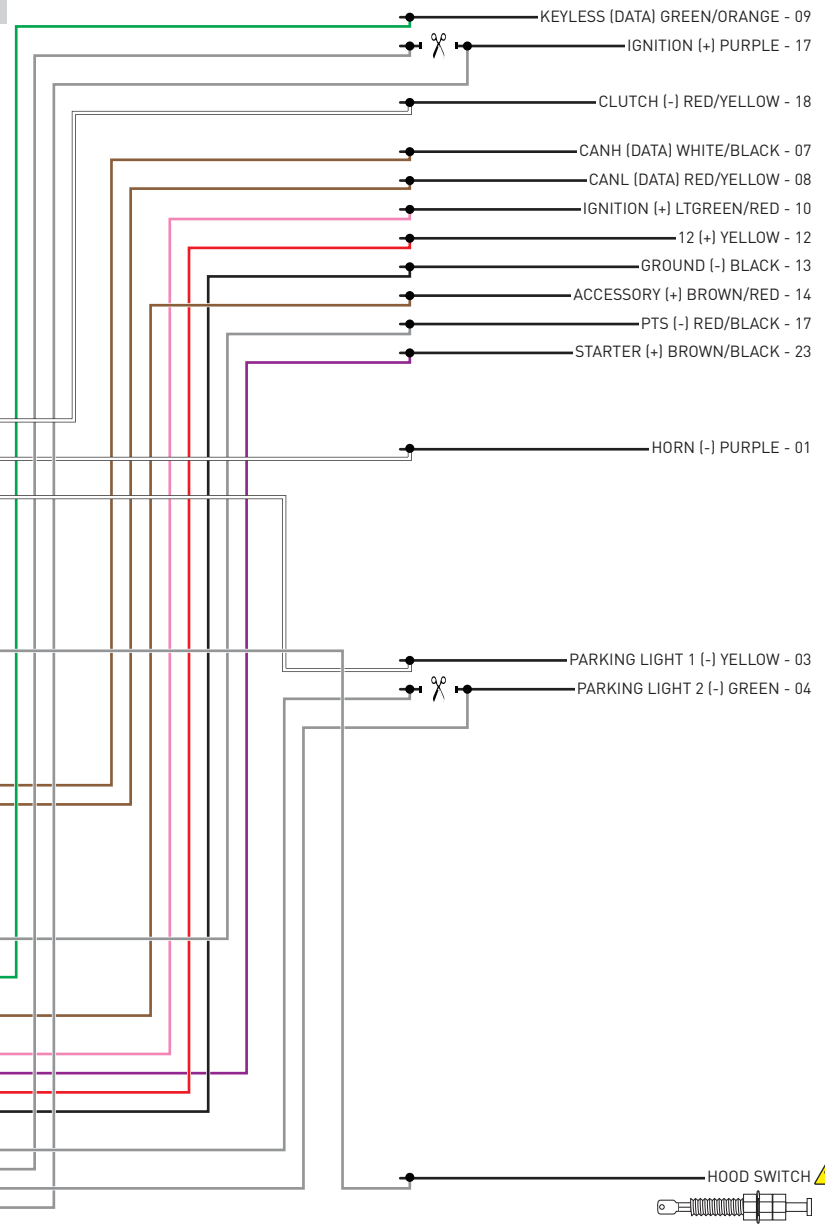

INSTALL THE SUPPLIED HOOD SWITCH IF THE VEHICLE IS NOT EQUIPPED WITH ONE SET THE PROGRAMMING OPTION THROUGH WEBLINK AS FOLLOWS:
 IN "MENU #7 INPUTS CONFIGURATION",
 FOR "4-HOOD INPUT SOURCE" SELECT "1-ANALOG".

START STOP UNIT, UNDER STEERING COLUMN (A)

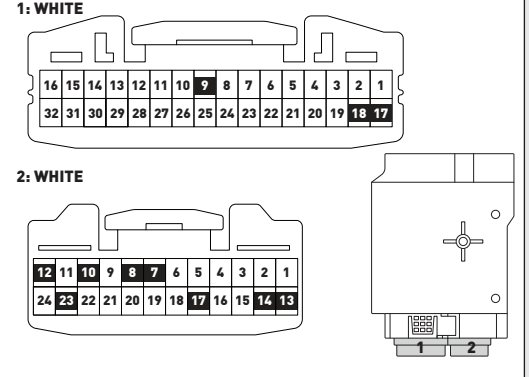

CLOCK SPRING (B)

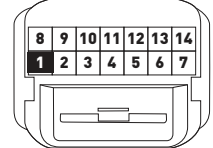

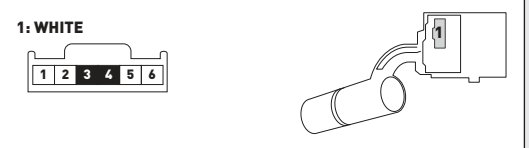

PARKING LIGHTS SWITCH, LEFT OF STEERING COLUMN (C)



>>  WARNING: All vehicle doors must be closed and locked prior to remote start sequence.

01  Set ignition to ON position.

02  Wait, LED 1 will turn solid RED to confirm that the ignition is ON.

03  Wait 10 seconds, LED 1 will flash GREEN rapidly.

04  Set ignition to OFF position.

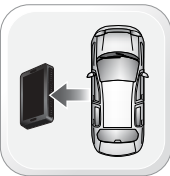
05  WARNING: Disconnect power last. Disconnect module from vehicle.

06  Connect module to computer and proceed with extended programming.

07  Connect power first. Connect module to vehicle.

08  Set ignition to ON position.

09  Wait, LED 1 will turn solid RED to confirm that the ignition is ON.

10  Wait, LED 1 will turn solid GREEN for 2 seconds.

11  Set ignition to OFF position.

>>  If vehicle is equipped with power liftgate: open and close the power liftgate with OEM keyfob.

12  START vehicle for 15 seconds.

13  Press and hold the brake pedal.

14  Press and release the module's programming button.

15  Release the brake pedal.

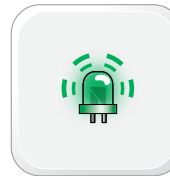
16  Wait, LED 2 will flash GREEN. Module Programming Procedure completed.

>>



All vehicle doors must be closed and locked prior to remote start sequence.

01



Time restriction. Complete steps 2 to 5 within 45 seconds.

02



Press unlock on OEM or aftermarket remote or request switch.

03



Open driver door and enter vehicle.

04



Close driver door.

05



Press and release BRAKE pedal.

06



Take over procedure completed.

>>



Failure to follow procedure will result in vehicle engine shutdown.

CHECKLIST - WITH AFTERMARKET KEYFOB

1	WARNING: Vehicle engine will start many times. Test in a well ventilated area.	9	Press the START/STOP button once [1x] on the aftermarket keyfob to shut down vehicle.
2	Close all vehicle doors, hood and trunk.		Question 7: Does the vehicle shut down?
3	Press the LOCK button once [1x] on the aftermarket keyfob.	<input type="checkbox"/>	YES: Go to next step.
	Question 1: Do the doors lock?	<input type="checkbox"/>	NO: Repeat step. If problem persists, press the brake pedal once [1x] to shut down the vehicle and call technical support.
<input type="checkbox"/>	YES: Go to next step.	10	RAP and auto light shutdown test
<input type="checkbox"/>	NO: Verify the remote programming, the RF connections and the wired door lock/unlock connections as illustrated in the wiring diagram, if applicable. Repeat the test and call technical support, if the problem persists.		Question 8: Did the radio, interior controls and headlights turn off within 60 seconds after remote start shutdown?
4	Press the UNLOCK button once [1x] on the aftermarket keyfob.	<input type="checkbox"/>	YES: Go to next step.
	Question 2: Do the doors unlock?	<input type="checkbox"/>	NO: Verify the RAP SHUTDOWN connections as illustrated in the wiring diagram. Repeat the test and call technical support if the problem persists.
<input type="checkbox"/>	YES: Go to next step.	11	Open hood.
<input type="checkbox"/>	NO: Verify the remote programming, the RF connections and the wired door lock/unlock connections as illustrated in the wiring diagram, if applicable. Repeat the test and call technical support, if the problem persists.	12	If not already installed, affix the mandatory orange warning sticker under the hood and proceed to next step.
5	Press the TRUNK release button once [1x] on the aftermarket keyfob if supported.	13	Press the START/STOP button once [1x] on the aftermarket keyfob to remote start vehicle.
	Question 3: Does the trunk or hatch open/unlock?		Question 9: Does the vehicle remote start?
<input type="checkbox"/>	YES: Close trunk or hatch and go to next step.	<input type="checkbox"/>	YES: The vehicle is not equipped with a factory hood pin. Install a mandatory aftermarket hood switch, then repeat the test.
<input type="checkbox"/>	NO: Verify the remote programming, the RF connections and the wired trunk/hatch connections as illustrated in the wiring diagram, if applicable. Repeat the test and call technical support, if the problem persists.	<input type="checkbox"/>	NO: Go to next step.
6	Press the AUX 1 button once [1x] on the aftermarket keyfob if supported.	14	Close hood.
	Question 4: Does the driver side sliding door open?	15	Enter vehicle and close the doors.
<input type="checkbox"/>	YES: Press the AUX 1 button once [1x] to close the driver sliding door and go to next step.	16	Press the START/STOP button once [1x] on the aftermarket keyfob to remote start vehicle.
<input type="checkbox"/>	NO: Verify the remote programming and the RF connections. Repeat the test and call technical support, if the problem persists.	17	Wait for the vehicle to start.
7	Press the AUX 2 button once [1x] on the aftermarket keyfob if supported.	18	Press brake pedal.
	Question 5: Does the passenger side sliding door open?		Question 10: Does the vehicle shut down?
<input type="checkbox"/>	YES: Press the AUX 2 button once [1x] to close the passenger sliding door and go to next step.	<input type="checkbox"/>	YES: Go to next step.
<input type="checkbox"/>	NO: Verify the remote programming and the RF connections. Repeat the test and call technical support, if the problem persists.	<input type="checkbox"/>	NO: The module does NOT detect the brake pedal signal. Press the START/STOP button once [1x] on the aftermarket keyfob to shut down vehicle, check connection as illustrated in the wiring diagram, if applicable, and call technical support.
8	Press the START/STOP button once [1x] on the aftermarket keyfob to remote start vehicle.	19	Exit vehicle.
	Question 6: Does the vehicle remote start?	20	Installation checklist completed.
<input type="checkbox"/>	YES: Go to next step.		
<input type="checkbox"/>	NO: Verify the remote programming, the RF connections and check the remote start error codes. Repeat the test and call technical support, if the problem persists.		

CHECKLIST - WITH OEM KEYFOB

1	WARNING: Vehicle engine will start many times. Test in a well ventilated area.
2	Close all vehicle doors, hood and trunk.
3	Press LOCK button three times [3x] rapidly on the OEM keyfob to remote start vehicle.
	Question 1: Does the vehicle remote start?
<input type="checkbox"/>	YES: Go to next step.
<input type="checkbox"/>	NO: The module doesn't detect OEM remote lock button from the vehicle communication network. Check all connections, repeat the test and call technical support, if the problem persists.
4	Press LOCK button three times [3x] rapidly on the OEM keyfob to shut down vehicle.
	Question 2: Does the vehicle shut down?
<input type="checkbox"/>	YES: Go to next step.
<input type="checkbox"/>	NO: Repeat step. If the problem persists, press on the brake pedal once [1x] to shut down the vehicle and call technical support.
5	RAP Shutdown test
	Question 3: Did the radio, interior controls, and headlights turn off within 60 seconds after remote start shutdown?
<input type="checkbox"/>	YES: Go to next step.
<input type="checkbox"/>	NO: Verify the RAP SHUTDOWN connections as illustrated in the wiring diagram. Repeat the test and call technical support, if the problem persists.
6	Open hood.
7	If not already installed, affix the mandatory orange warning sticker under the hood and proceed to next step.
8	Press LOCK button three times [3x] rapidly on the OEM keyfob to remote start vehicle.
	Question 4: Does the vehicle remote start?
<input type="checkbox"/>	YES: The vehicle is not equipped with a factory hood pin. Install a mandatory aftermarket hood switch, then repeat the test.
<input type="checkbox"/>	NO: Go to next step.
9	Close hood.
10	Enter vehicle and close the doors.
11	Press LOCK button three times [3x] rapidly on the OEM keyfob to remote start vehicle.
12	Wait for the vehicle to start.
13	Press brake pedal.
	Question 5: Does the vehicle shut down?
<input type="checkbox"/>	YES: Go to next step.
<input type="checkbox"/>	NO: The module does NOT detect the brake pedal signal. Press LOCK button three times [3x] rapidly on the OEM keyfob to shut down, check the brake connection as illustrated in the wiring diagram, if applicable, and call technical support.
14	Exit vehicle.
15	Installation checklist completed.



INSTALL GUIDE

2017-2018 MAZDA CX-5 PTS AT

DOCUMENT NUMBER

REVISION DATE

20180829

FIRMWARE

ADS-RSA-MA3-[HCX000A]

HARDWARE

HCX000A

ACCESSORIES

ATTENTION: TO COMPLETE THIS INSTALLATION SOME ACCESSORIES MAY BE REQUIRED. VISIT OUR WEBSITE TO SEE ALL THE REQUIRED ACCESSORIES FOR YOUR VEHICLE.

TERMS OF USE

Automotive Data Solutions Inc. ("ADS") products are strictly intended for installation by Certified Technicians who are employed by a registered business specialized in the installation of automotive aftermarket electronics products. Prior to beginning installation of an ADS product in a vehicle, it is the Certified Technician's responsibility to review the most current Product Guide, Install Guide and vehicle-specific notes available in Weblink®. ADS is not responsible for any damages whatsoever, including but not limited to any consequential damages, incidental damages, damages for loss of time, loss of earnings, loss of profit, commercial loss, loss of economic opportunity and the like that may or may not have resulted from the use, misuse, improper installation or operation of its products. ADS reserves itself the right to suspend any Weblink® account without notice and decline to offer technical support to non-Certified Technicians, non-compliant Certified Technicians or end users.



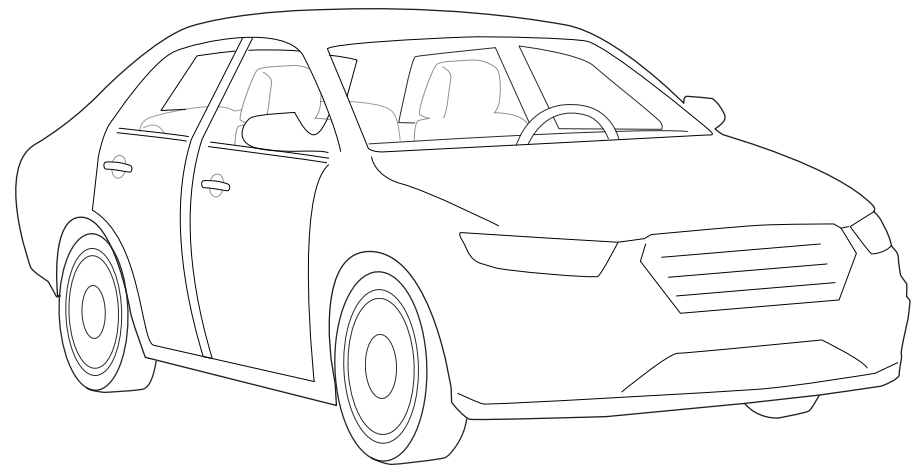
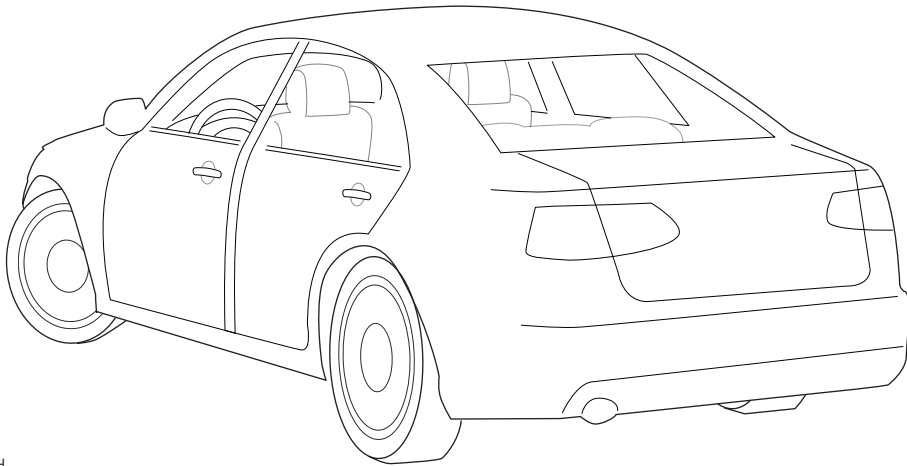
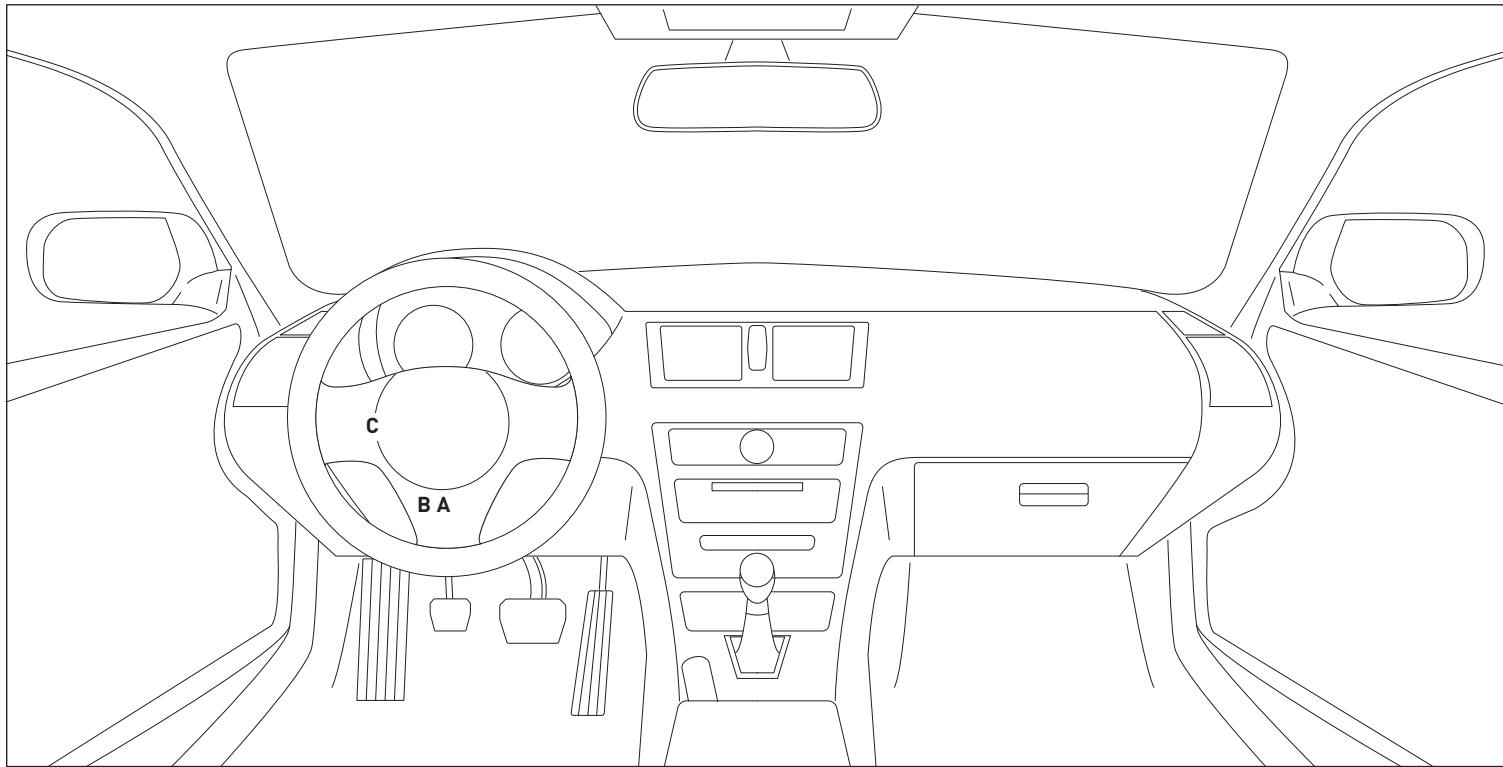

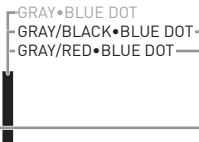
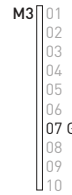
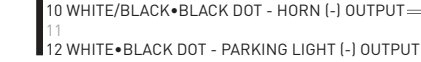
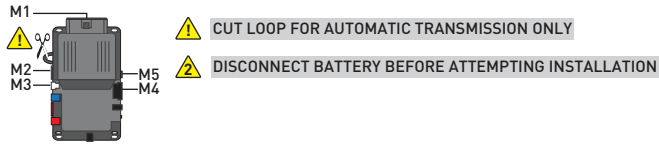

MS1



MS2

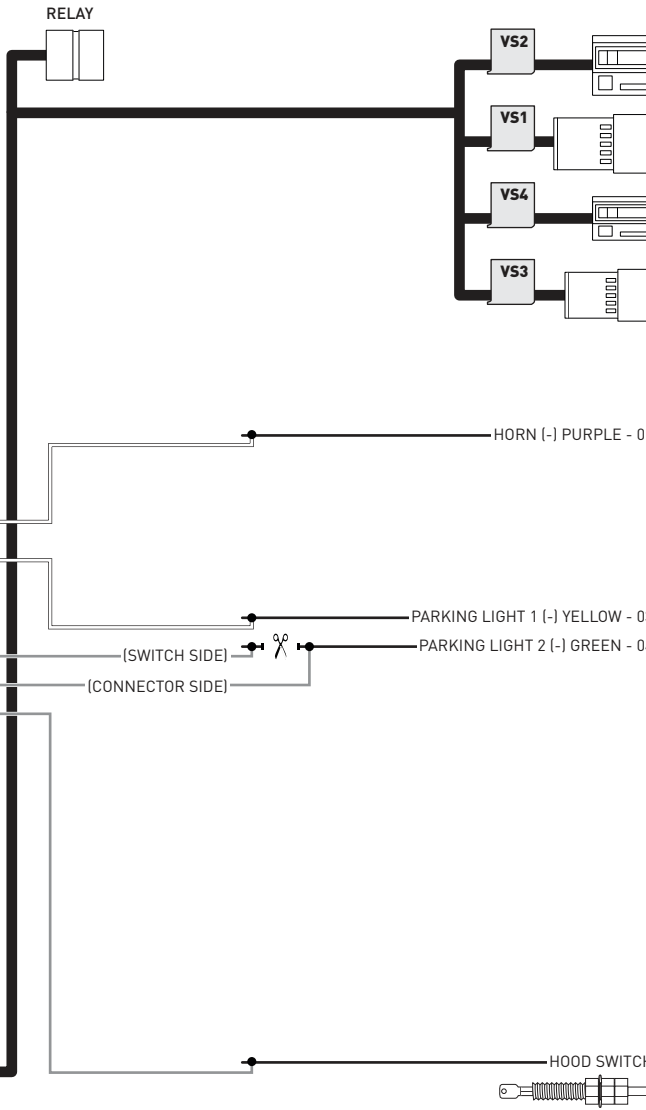

⚠ INSTALL THE SUPPLIED HOOD SWITCH **⚠**
IF THE VEHICLE IS NOT EQUIPPED WITH ONE
SET THE PROGRAMMING OPTION THROUGH WEBLINK AS FOLLOWS:
IN "MENU #7 INPUTS CONFIGURATION",
FOR "4-HOOD INPUT SOURCE" SELECT "1-ANALOG".

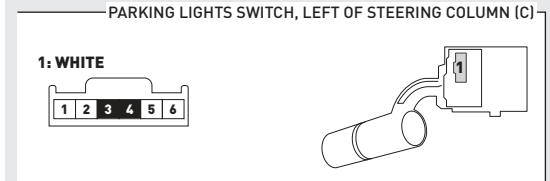
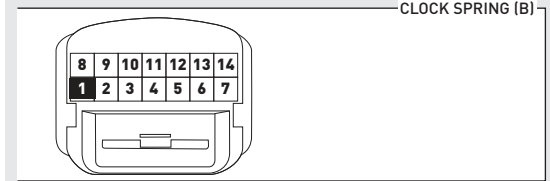
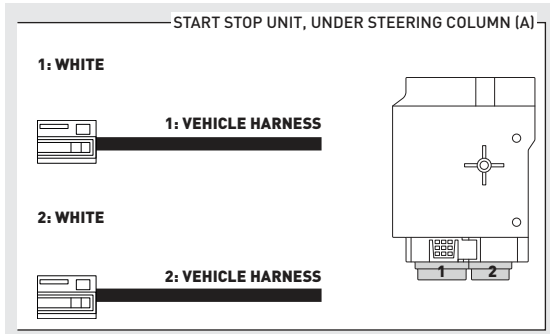

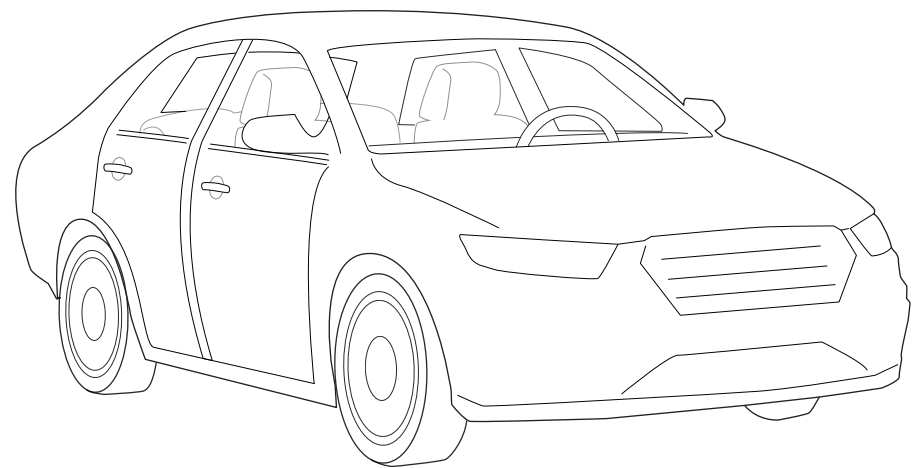
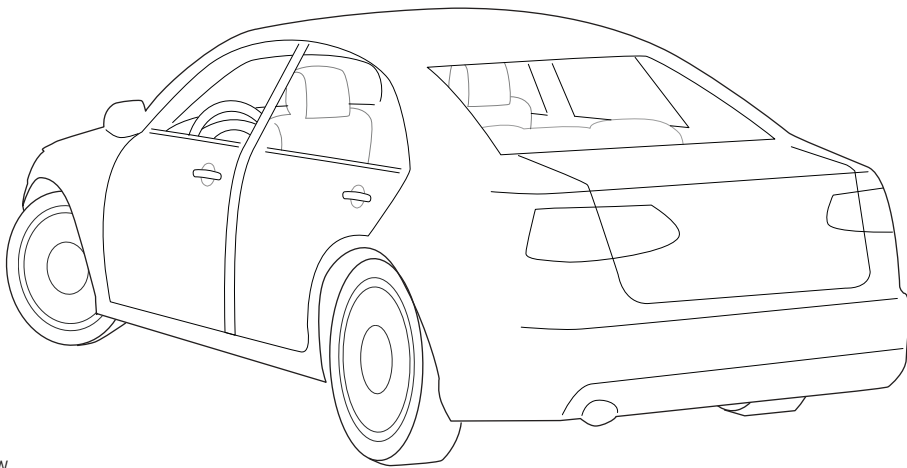
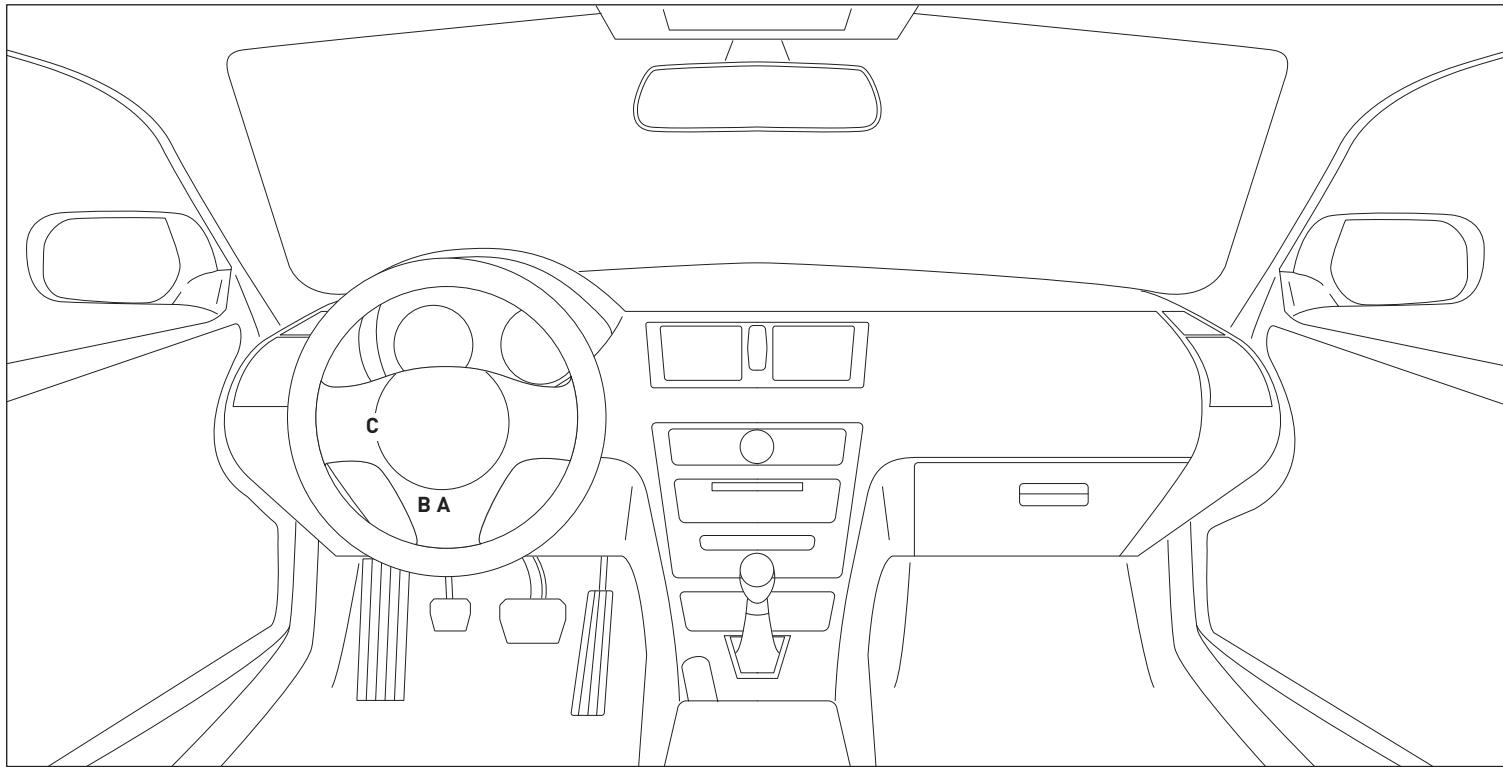

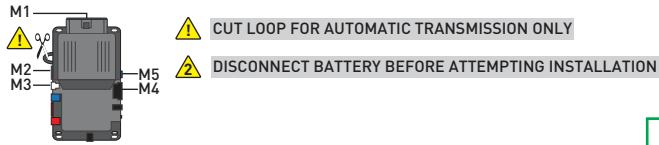

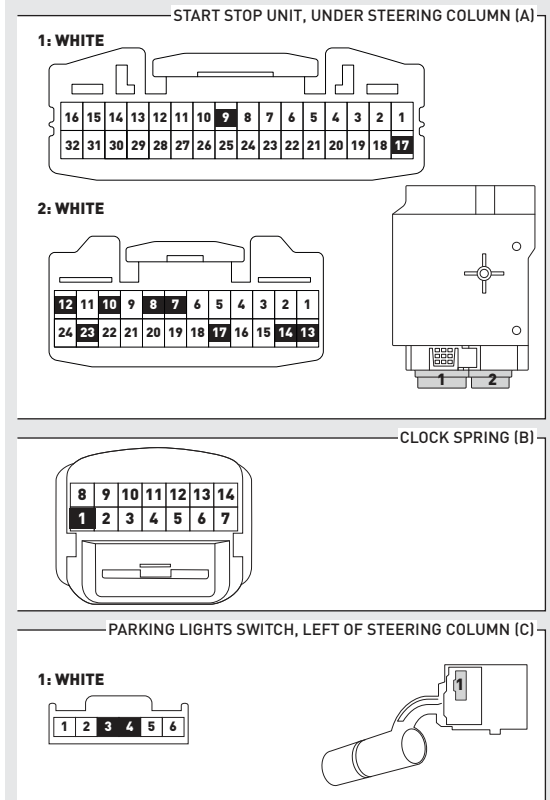
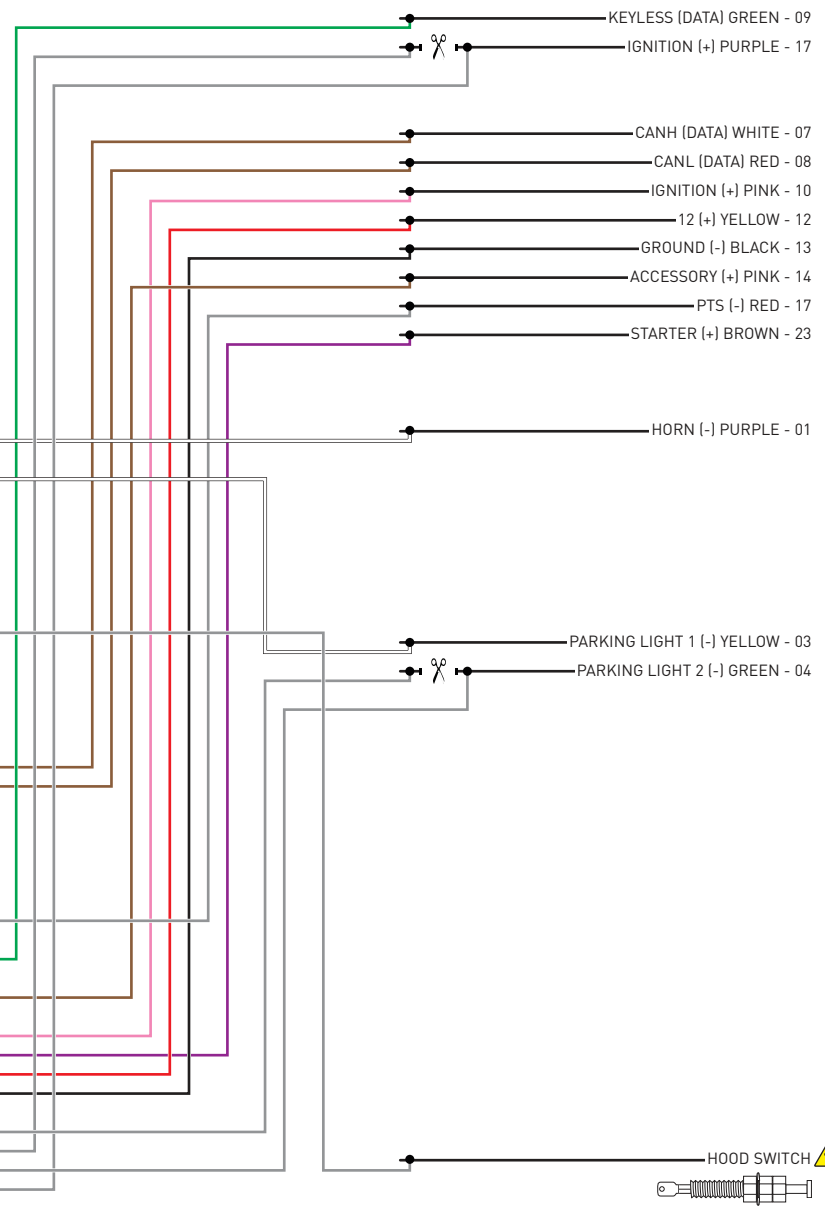

- M1**
 - 01 ORANGE
 - 02 RED
 - 03 PURPLE
 - 04 PINK/WHITE
 - 05 PINK
 - 06 WHITE
 - 07 RED
 - 08 BLACK
- M2**
 - 01 GREEN•BLACK DOT
 - 02 BLUE•BLACK DOT
 - 03 RED/WHITE•BLACK DOT
 - 04 GREEN/WHITE•BLACK DOT
 - 05 GREEN/BLACK•BLACK DOT
 - 06 BLUE/WHITE•BLACK DOT
 - 07 EMPTY
 - 08 WHITE/PURPLE•BLACK DOT
 - 09 PURPLE/BLACK•BLACK DOT
 - 10 WHITE/BLACK•BLACK DOT - HORN (-) OUTPUT
 - 11 BROWN/BLACK•BLACK DOT
 - 12 WHITE•BLACK DOT
- M3**
 - 01 BROWN•SILVER DOT
 - 02 BLACK/WHITE•SILVER DOT
 - 03 PURPLE•SILVER DOT
 - 04 GREEN•SILVER DOT
 - 05 PURPLE/WHITE•SILVER DOT
 - 06 WHITE/BLUE•SILVER DOT
 - 07 GRAY•SILVER DOT - HOOD STATUS (-) INPUT
 - 08 BLUE•SILVER DOT
 - 09 GRAY/BLACK•SILVER DOT
 - 10 EMPTY
- M4**
 - 01 EMPTY
 - 02 EMPTY
 - 03 BROWN/RED - CANH 1
 - 04 BROWN/YELLOW - CANL 1
 - 05 BLUE/RED
 - 06 BLUE/YELLOW
 - 07 EMPTY
 - 08 ORANGE
 - 09 YELLOW
 - 10 EMPTY
 - 11 GRAY/RED - PTS (-) OUTPUT
 - 12 GRAY/YELLOW
 - 13 GREEN/RED - KEYLESS DATA
 - 14 ORANGE/WHITE
 - 15 BROWN - ACCESSORY (+) IN/OUT
 - 16 ORANGE/BLACK
 - 17 PINK - IGNITION (+) IN/OUT
 - 18 PURPLE - STARTER (+) OUTPUT
 - 19 RED - 12V (+) INPUT
 - 20 BLACK - GROUND (-)
- M5**
 - 01 GRAY/BLACK•BLUE DOT - PARKING LIGHT 2 (-) SWITCH SIDE
 - 02 WHITE/BLACK•BLU DOTE - IGNITION (+)
 - 03 GRAY/RED•BLUE DOT - PARKING LIGHT 2 (-) CONNECTOR SIDE
 - 04 WHITE/RED•BLUE DOT - IGNITION (+)
 - 05 GRAY•BLUE DOT - PARKING LIGHT 1 (-) OUTPUT
 - 06 WHITE•BLUE DOT





⚠ INSTALL THE SUPPLIED HOOD SWITCH IF THE VEHICLE IS NOT EQUIPPED WITH ONE SET THE PROGRAMMING OPTION THROUGH WEBLINK AS FOLLOWS: IN "MENU #7 INPUTS CONFIGURATION", FOR "4-HOOD INPUT SOURCE" SELECT "1-ANALOG".

>>  WARNING: All vehicle doors must be closed and locked prior to remote start sequence.

01  Set ignition to ON position.

02  Wait, LED 1 will turn solid RED to confirm that the ignition is ON.

03  Wait 10 seconds, LED 1 will flash GREEN rapidly.

04  Set ignition to OFF position.

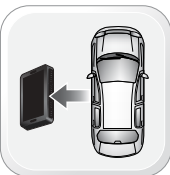
05  WARNING: Disconnect power last. Disconnect module from vehicle.

06  Connect module to computer and proceed with extended programming.

07  Connect power first. Connect module to vehicle.

08  Set ignition to ON position.

09  Wait, LED 1 will turn solid RED to confirm that the ignition is ON.

10  Wait, LED 1 will turn solid GREEN for 2 seconds.

11  Set ignition to OFF position.

>>  If vehicle is equipped with power liftgate: open and close the power liftgate with OEM keyfob.

12  START vehicle for 15 seconds.

13  Press and hold the brake pedal.

14  Press and release the module's programming button.

15  Release the brake pedal.

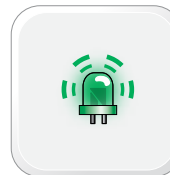
16  Wait, LED 2 will flash GREEN. Module Programming Procedure completed.

>>



All vehicle doors must be closed and locked prior to remote start sequence.

01



Time restriction. Complete steps 2 to 5 within 45 seconds.

02



Press unlock on OEM or aftermarket remote or request switch.

03



Open driver door and enter vehicle.

04



Close driver door.

05



Press and release BRAKE pedal.

06



Take over procedure completed.

>>



Failure to follow procedure will result in vehicle engine shutdown.

CHECKLIST - WITH AFTERMARKET KEYFOB

1	WARNING: Vehicle engine will start many times. Test in a well ventilated area.	9	Press the START/STOP button once [1x] on the aftermarket keyfob to shut down vehicle.
2	Close all vehicle doors, hood and trunk.		Question 7: Does the vehicle shut down?
3	Press the LOCK button once [1x] on the aftermarket keyfob.	<input type="checkbox"/>	YES: Go to next step.
	Question 1: Do the doors lock?	<input type="checkbox"/>	NO: Repeat step. If problem persists, press the brake pedal once [1x] to shut down the vehicle and call technical support.
<input type="checkbox"/>	YES: Go to next step.	10	RAP and auto light shutdown test
<input type="checkbox"/>	NO: Verify the remote programming, the RF connections and the wired door lock/unlock connections as illustrated in the wiring diagram, if applicable. Repeat the test and call technical support, if the problem persists.		Question 8: Did the radio, interior controls and headlights turn off within 60 seconds after remote start shutdown?
4	Press the UNLOCK button once [1x] on the aftermarket keyfob.	<input type="checkbox"/>	YES: Go to next step.
	Question 2: Do the doors unlock?	<input type="checkbox"/>	NO: Verify the RAP SHUTDOWN connections as illustrated in the wiring diagram. Repeat the test and call technical support if the problem persists.
<input type="checkbox"/>	YES: Go to next step.	11	Open hood.
<input type="checkbox"/>	NO: Verify the remote programming, the RF connections and the wired door lock/unlock connections as illustrated in the wiring diagram, if applicable. Repeat the test and call technical support, if the problem persists.	12	If not already installed, affix the mandatory orange warning sticker under the hood and proceed to next step.
5	Press the TRUNK release button once [1x] on the aftermarket keyfob if supported.	13	Press the START/STOP button once [1x] on the aftermarket keyfob to remote start vehicle.
	Question 3: Does the trunk or hatch open/unlock?		Question 9: Does the vehicle remote start?
<input type="checkbox"/>	YES: Close trunk or hatch and go to next step.	<input type="checkbox"/>	YES: The vehicle is not equipped with a factory hood pin. Install a mandatory aftermarket hood switch, then repeat the test.
<input type="checkbox"/>	NO: Verify the remote programming, the RF connections and the wired trunk/hatch connections as illustrated in the wiring diagram, if applicable. Repeat the test and call technical support, if the problem persists.	<input type="checkbox"/>	NO: Go to next step.
6	Press the AUX 1 button once [1x] on the aftermarket keyfob if supported.	14	Close hood.
	Question 4: Does the driver side sliding door open?	15	Enter vehicle and close the doors.
<input type="checkbox"/>	YES: Press the AUX 1 button once [1x] to close the driver sliding door and go to next step.	16	Press the START/STOP button once [1x] on the aftermarket keyfob to remote start vehicle.
<input type="checkbox"/>	NO: Verify the remote programming and the RF connections. Repeat the test and call technical support, if the problem persists.	17	Wait for the vehicle to start.
7	Press the AUX 2 button once [1x] on the aftermarket keyfob if supported.	18	Press brake pedal.
	Question 5: Does the passenger side sliding door open?		Question 10: Does the vehicle shut down?
<input type="checkbox"/>	YES: Press the AUX 2 button once [1x] to close the passenger sliding door and go to next step.	<input type="checkbox"/>	YES: Go to next step.
<input type="checkbox"/>	NO: Verify the remote programming and the RF connections. Repeat the test and call technical support, if the problem persists.	<input type="checkbox"/>	NO: The module does NOT detect the brake pedal signal. Press the START/STOP button once [1x] on the aftermarket keyfob to shut down vehicle, check connection as illustrated in the wiring diagram, if applicable, and call technical support.
8	Press the START/STOP button once [1x] on the aftermarket keyfob to remote start vehicle.	19	Exit vehicle.
	Question 6: Does the vehicle remote start?	20	Installation checklist completed.
<input type="checkbox"/>	YES: Go to next step.		
<input type="checkbox"/>	NO: Verify the remote programming, the RF connections and check the remote start error codes. Repeat the test and call technical support, if the problem persists.		

CHECKLIST - WITH OEM KEYFOB

1	WARNING: Vehicle engine will start many times. Test in a well ventilated area.
2	Close all vehicle doors, hood and trunk.
3	Press LOCK button three times [3x] rapidly on the OEM keyfob to remote start vehicle.
	Question 1: Does the vehicle remote start?
<input type="checkbox"/>	YES: Go to next step.
<input type="checkbox"/>	NO: The module doesn't detect OEM remote lock button from the vehicle communication network. Check all connections, repeat the test and call technical support, if the problem persists.
4	Press LOCK button three times [3x] rapidly on the OEM keyfob to shut down vehicle.
	Question 2: Does the vehicle shut down?
<input type="checkbox"/>	YES: Go to next step.
<input type="checkbox"/>	NO: Repeat step. If the problem persists, press on the brake pedal once [1x] to shut down the vehicle and call technical support.
5	RAP Shutdown test
	Question 3: Did the radio, interior controls, and headlights turn off within 60 seconds after remote start shutdown?
<input type="checkbox"/>	YES: Go to next step.
<input type="checkbox"/>	NO: Verify the RAP SHUTDOWN connections as illustrated in the wiring diagram. Repeat the test and call technical support, if the problem persists.
6	Open hood.
7	If not already installed, affix the mandatory orange warning sticker under the hood and proceed to next step.
8	Press LOCK button three times [3x] rapidly on the OEM keyfob to remote start vehicle.
	Question 4: Does the vehicle remote start?
<input type="checkbox"/>	YES: The vehicle is not equipped with a factory hood pin. Install a mandatory aftermarket hood switch, then repeat the test.
<input type="checkbox"/>	NO: Go to next step.
9	Close hood.
10	Enter vehicle and close the doors.
11	Press LOCK button three times [3x] rapidly on the OEM keyfob to remote start vehicle.
12	Wait for the vehicle to start.
13	Press brake pedal.
	Question 5: Does the vehicle shut down?
<input type="checkbox"/>	YES: Go to next step.
<input type="checkbox"/>	NO: The module does NOT detect the brake pedal signal. Press LOCK button three times [3x] rapidly on the OEM keyfob to shut down, check the brake connection as illustrated in the wiring diagram, if applicable, and call technical support.
14	Exit vehicle.
15	Installation checklist completed.



INSTALL GUIDE

2017-2018 MAZDA CX-5 PTS MT

DOCUMENT NUMBER

REVISION DATE

20180829

FIRMWARE

ADS-RSA-MA3-[HCX000A]

HARDWARE

HCX000A

ACCESSORIES

ATTENTION: TO COMPLETE THIS INSTALLATION SOME ACCESSORIES MAY BE REQUIRED. VISIT OUR WEBSITE TO SEE ALL THE REQUIRED ACCESSORIES FOR YOUR VEHICLE.

TERMS OF USE

Automotive Data Solutions Inc. ("ADS") products are strictly intended for installation by Certified Technicians who are employed by a registered business specialized in the installation of automotive aftermarket electronics products. Prior to beginning installation of an ADS product in a vehicle, it is the Certified Technician's responsibility to review the most current Product Guide, Install Guide and vehicle-specific notes available in Weblink®. ADS is not responsible for any damages whatsoever, including but not limited to any consequential damages, incidental damages, damages for loss of time, loss of earnings, loss of profit, commercial loss, loss of economic opportunity and the like that may or may not have resulted from the use, misuse, improper installation or operation of its products. ADS reserves itself the right to suspend any Weblink® account without notice and decline to offer technical support to non-Certified Technicians, non-compliant Certified Technicians or end users.



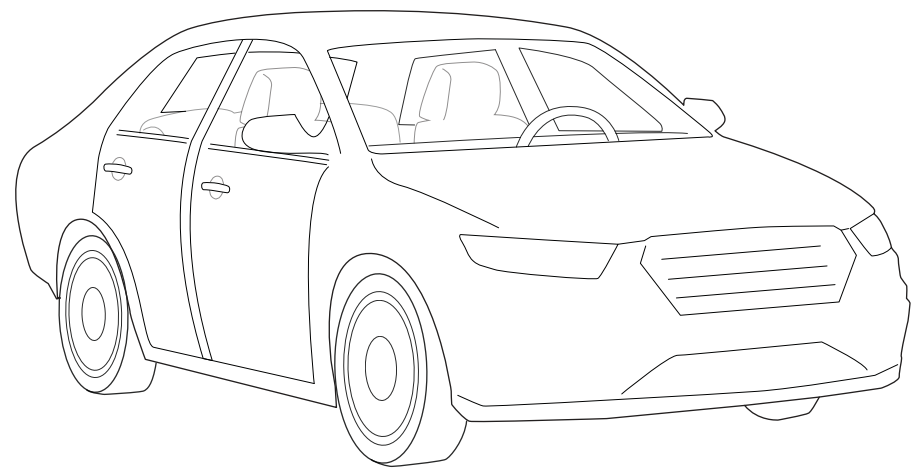
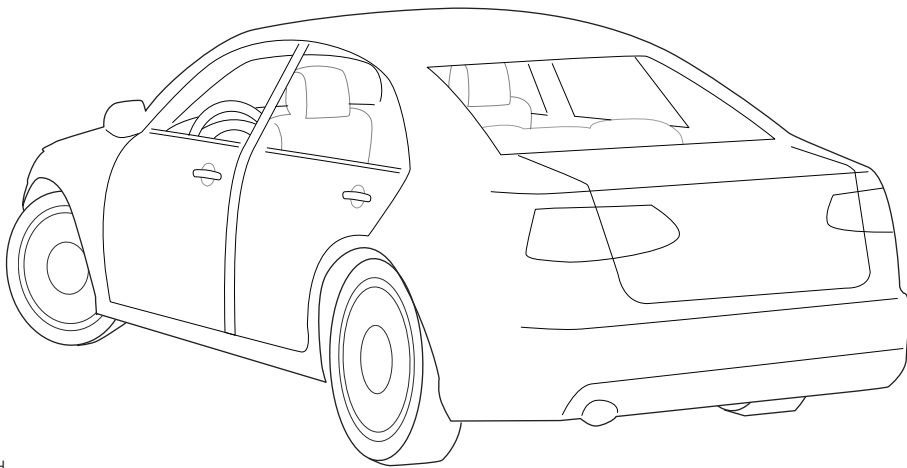
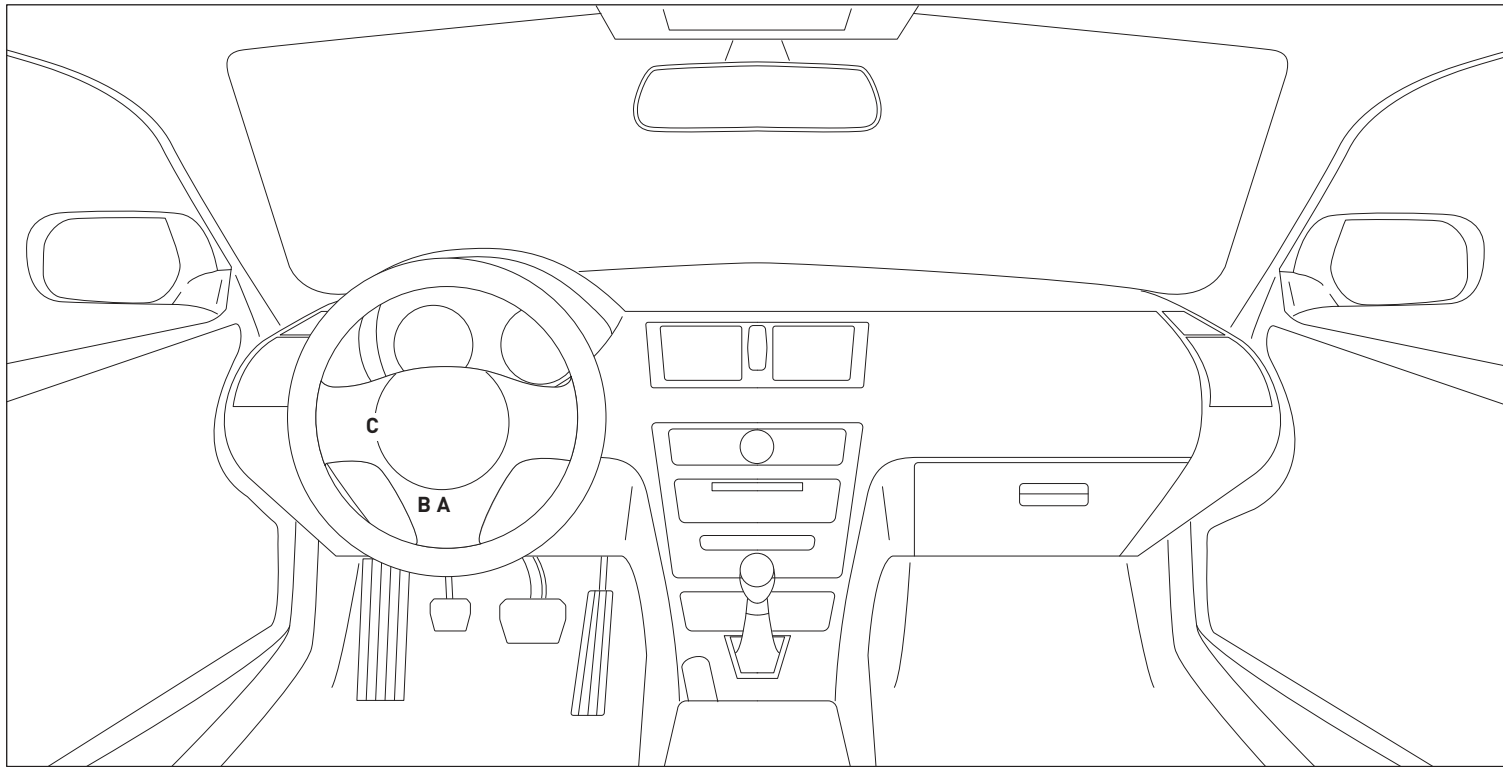

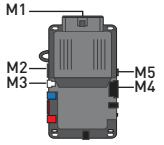

MANDATORY STEPS FOR MANUAL TRANSMISSION:
 1- DO NOT CUT THE LOOP.
 2- CONNECT THE MANUAL TRANSMISSION DIGITAL SENSOR.
 3- SEE THE PRODUCT GUIDE FOR MORE INFORMATION.

DISCONNECT BATTERY BEFORE ATTEMPTING INSTALLATION

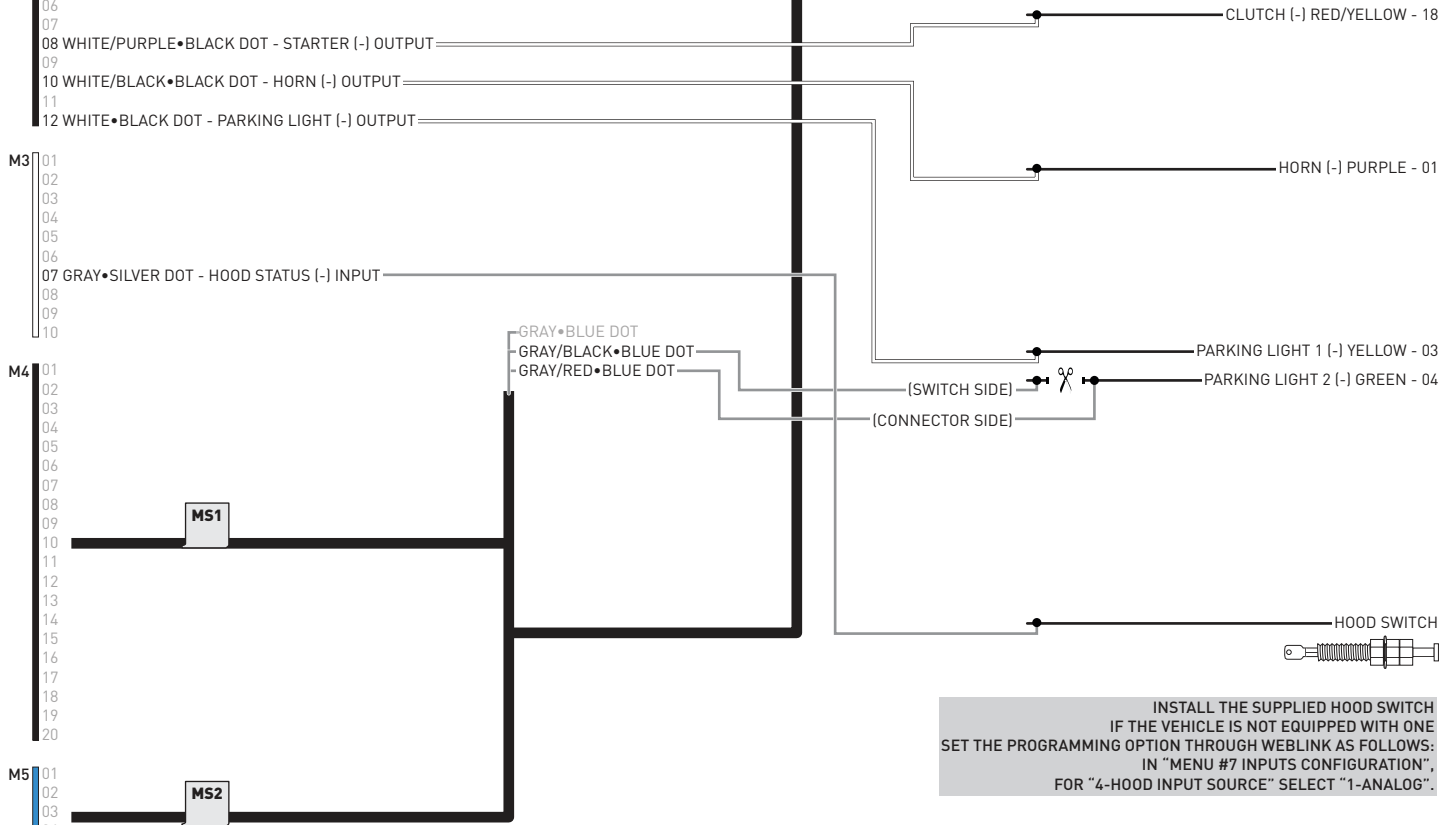
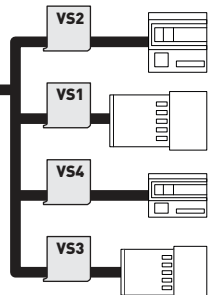

INSTALL THE SUPPLIED HOOD SWITCH IF THE VEHICLE IS NOT EQUIPPED WITH ONE SET THE PROGRAMMING OPTION THROUGH WEBLINK AS FOLLOWS: IN "MENU #7 INPUTS CONFIGURATION", FOR "4-HOOD INPUT SOURCE" SELECT "1-ANALOG".

START STOP UNIT, UNDER STEERING COLUMN (A)

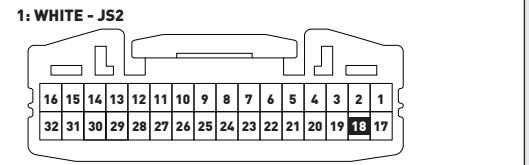
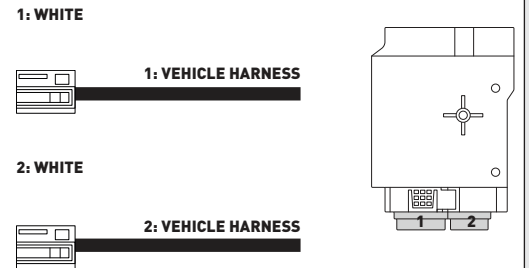

CLOCK SPRING (B)

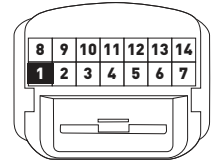

PARKING LIGHTS SWITCH, LEFT OF STEERING COLUMN (C)



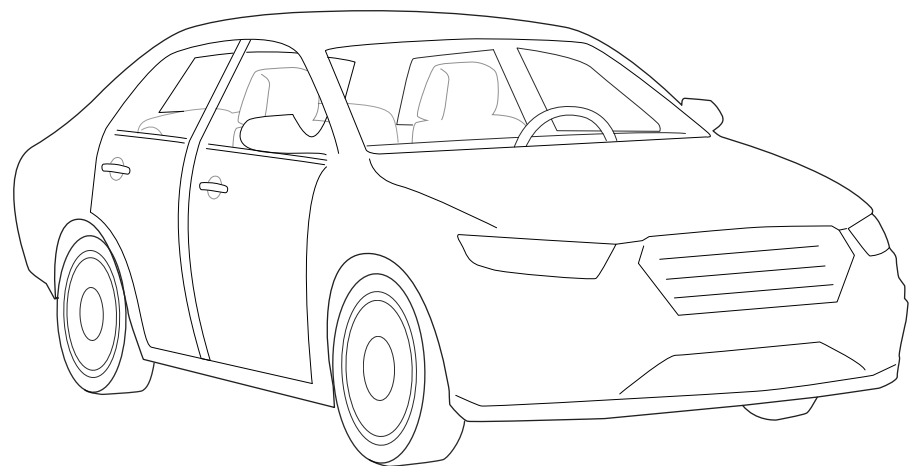
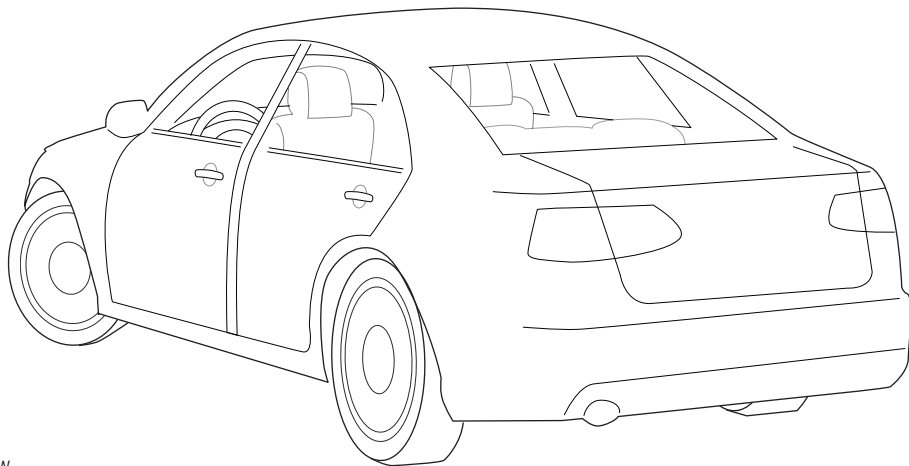
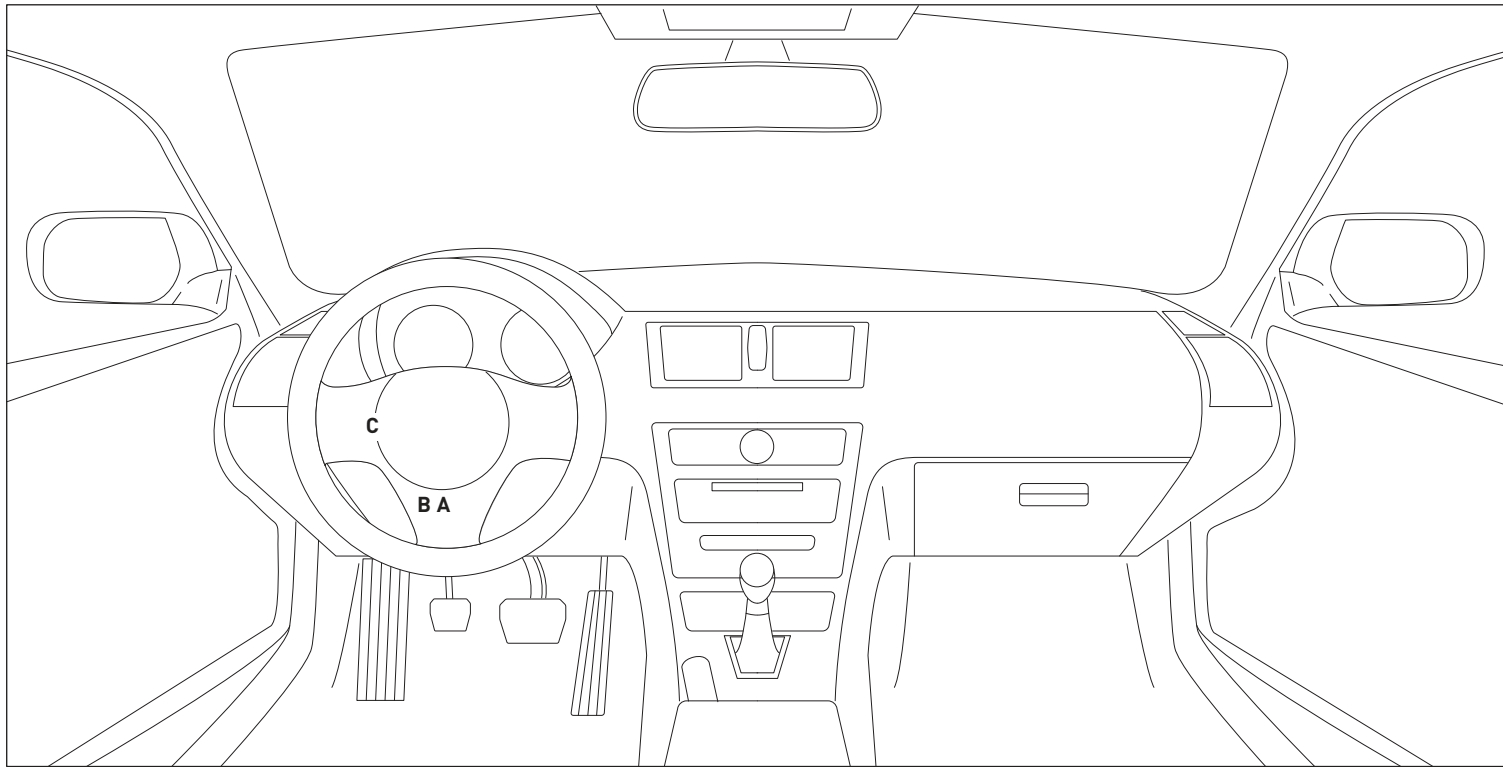

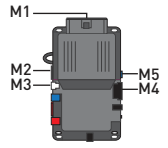

MANDATORY STEPS FOR MANUAL TRANSMISSION:
 1- DO NOT CUT THE LOOP.
 2- CONNECT THE MANUAL TRANSMISSION DIGITAL SENSOR.
 3- SEE THE PRODUCT GUIDE FOR MORE INFORMATION.

DISCONNECT BATTERY BEFORE ATTEMPTING INSTALLATION

- M1**
 - 01 ORANGE
 - 02 RED
 - 03 PURPLE
 - 04 PINK/WHITE
 - 05 PINK
 - 06 WHITE
 - 07 RED
 - 08 BLACK
- M2**
 - 01 GREEN•BLACK DOT
 - 02 BLUE•BLACK DOT
 - 03 RED/WHITE•BLACK DOT
 - 04 GREEN/WHITE•BLACK DOT
 - 05 GREEN/BLACK•BLACK DOT
 - 06 BLUE/WHITE•BLACK DOT
 - 07 EMPTY
 - 08 WHITE/PURPLE•BLACK DOT - STARTER (-) OUTPUT
 - 09 PURPLE/BLACK•BLACK DOT
 - 10 WHITE/BLACK•BLACK DOT - HORN (-) OUTPUT
 - 11 BROWN/BLACK•BLACK DOT
 - 12 WHITE•BLACK DOT - PARKING LIGHT (-) OUTPUT
- M3**
 - 01 BROWN•SILVER DOT
 - 02 BLACK/WHITE•SILVER DOT
 - 03 PURPLE•SILVER DOT
 - 04 GREEN•SILVER DOT
 - 05 PURPLE/WHITE•SILVER DOT
 - 06 WHITE/BLUE•SILVER DOT
 - 07 GRAY•SILVER DOT - HOOD STATUS (-) INPUT
 - 08 BLUE•SILVER DOT
 - 09 GRAY/BLACK•SILVER DOT
 - 10 EMPTY
- M4**
 - 01 EMPTY
 - 02 EMPTY
 - 03 BROWN/RED - CANH 1
 - 04 BROWN/YELLOW - CANL 1
 - 05 BLUE/RED
 - 06 BLUE/YELLOW
 - 07 EMPTY
 - 08 ORANGE
 - 09 YELLOW
 - 10 EMPTY
 - 11 GRAY/RED - PTS (-) OUTPUT
 - 12 GRAY/YELLOW
 - 13 GREEN/RED - KEYLESS DATA
 - 14 ORANGE/WHITE
 - 15 BROWN - ACCESSORY (+) IN/OUT
 - 16 ORANGE/BLACK
 - 17 PINK - IGNITION (+) IN/OUT
 - 18 PURPLE - STARTER (+) OUTPUT
 - 19 RED - 12V (+) INPUT
 - 20 BLACK - GROUND (-)
- M5**
 - 01 GRAY/BLACK•BLUE DOT - PARKING LIGHT 2 (-) SWITCH SIDE
 - 02 WHITE/BLACK•BLU DOTE - IGNITION (+) VEHICLE SIDE
 - 03 GRAY/RED•BLUE DOT - PARKING LIGHT 2 (-) CONNECTOR SIDE
 - 04 WHITE/RED•BLUE DOT - IGNITION (+) CONNECTOR SIDE
 - 05 GRAY•BLUE DOT
 - 06 WHITE•BLUE DOT

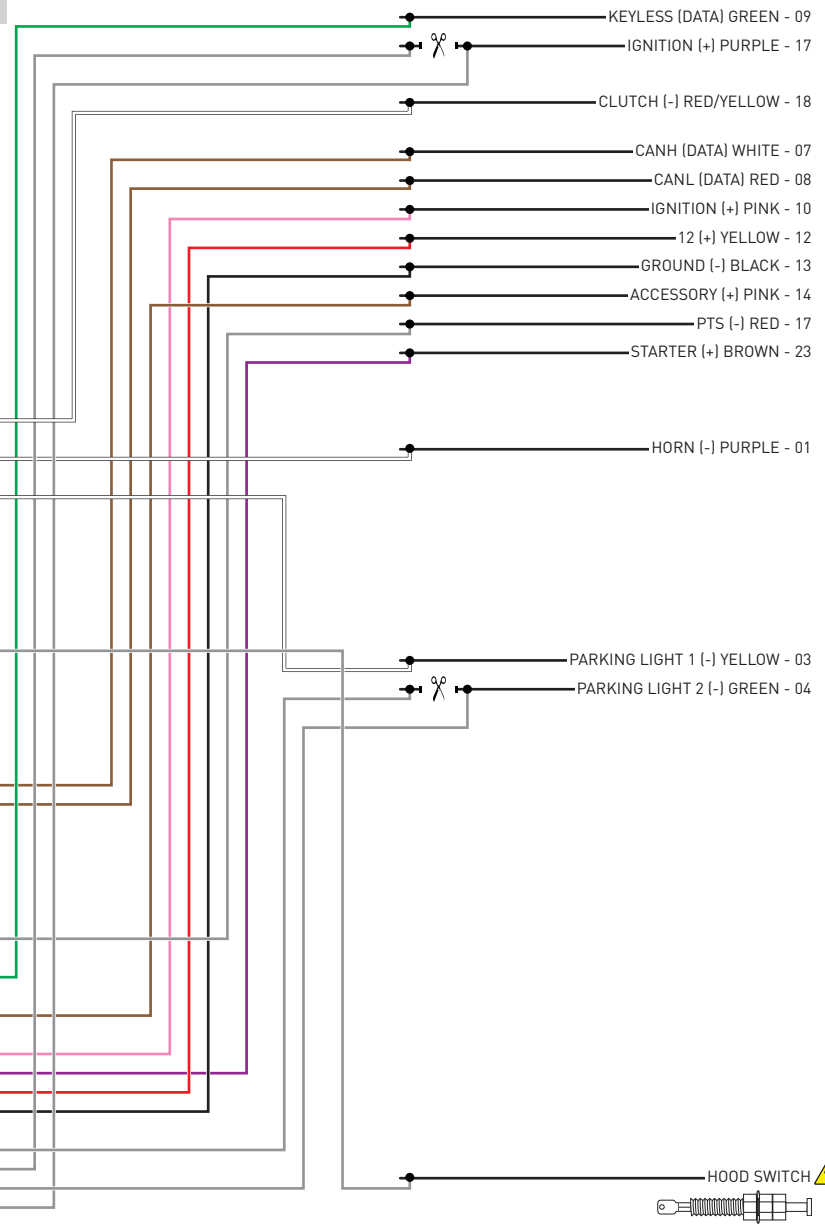

START STOP UNIT, UNDER STEERING COLUMN (A)

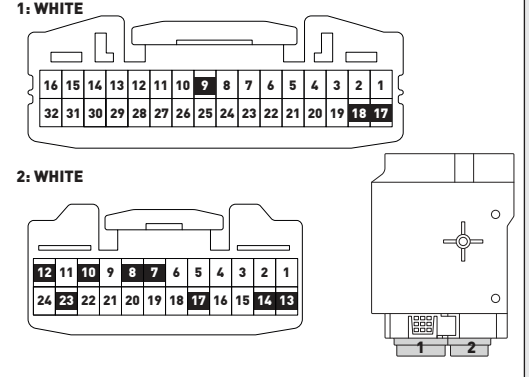

CLOCK SPRING (B)

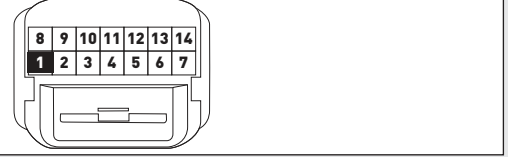

PARKING LIGHTS SWITCH, LEFT OF STEERING COLUMN (C)

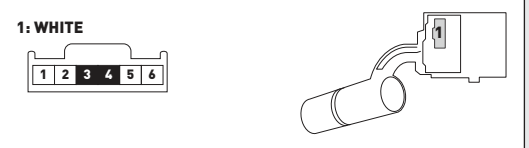



INSTALL THE SUPPLIED HOOD SWITCH IF THE VEHICLE IS NOT EQUIPPED WITH ONE SET THE PROGRAMMING OPTION THROUGH WEBLINK AS FOLLOWS:
 IN "MENU #7 INPUTS CONFIGURATION",
 FOR "4-HOOD INPUT SOURCE" SELECT "1-ANALOG".

>>  WARNING: All vehicle doors must be closed and locked prior to remote start sequence.

01  Set ignition to ON position.

02  Wait, LED 1 will turn solid RED to confirm that the ignition is ON.

03  Wait 10 seconds, LED 1 will flash GREEN rapidly.

04  Set ignition to OFF position.

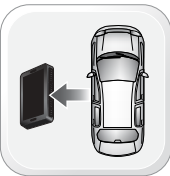
05  WARNING: Disconnect power last. Disconnect module from vehicle.

06  Connect module to computer and proceed with extended programming.

07  Connect power first. Connect module to vehicle.

08  Set ignition to ON position.

09  Wait, LED 1 will turn solid RED to confirm that the ignition is ON.

10  Wait, LED 1 will turn solid GREEN for 2 seconds.

11  Set ignition to OFF position.

>>  If vehicle is equipped with power liftgate: open and close the power liftgate with OEM keyfob.

12  START vehicle for 15 seconds.

13  Press and hold the brake pedal.

14  Press and release the module's programming button.

15  Release the brake pedal.

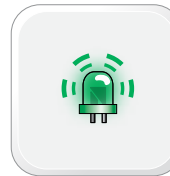
16  Wait, LED 2 will flash GREEN. Module Programming Procedure completed.

>>



All vehicle doors must be closed and locked prior to remote start sequence.

01



Time restriction. Complete steps 2 to 5 within 45 seconds.

02



Press unlock on OEM or aftermarket remote or request switch.

03



Open driver door and enter vehicle.

04



Close driver door.

05



Press and release BRAKE pedal.

06



Take over procedure completed.

>>



Failure to follow procedure will result in vehicle engine shutdown.

CHECKLIST - WITH AFTERMARKET KEYFOB

1	WARNING: Vehicle engine will start many times. Test in a well ventilated area.	9	Press the START/STOP button once [1x] on the aftermarket keyfob to shut down vehicle.
2	Close all vehicle doors, hood and trunk.		Question 7: Does the vehicle shut down?
3	Press the LOCK button once [1x] on the aftermarket keyfob.	<input type="checkbox"/>	YES: Go to next step.
	Question 1: Do the doors lock?	<input type="checkbox"/>	NO: Repeat step. If problem persists, press the brake pedal once [1x] to shut down the vehicle and call technical support.
<input type="checkbox"/>	YES: Go to next step.	10	RAP and auto light shutdown test
<input type="checkbox"/>	NO: Verify the remote programming, the RF connections and the wired door lock/unlock connections as illustrated in the wiring diagram, if applicable. Repeat the test and call technical support, if the problem persists.		Question 8: Did the radio, interior controls and headlights turn off within 60 seconds after remote start shutdown?
4	Press the UNLOCK button once [1x] on the aftermarket keyfob.	<input type="checkbox"/>	YES: Go to next step.
	Question 2: Do the doors unlock?	<input type="checkbox"/>	NO: Verify the RAP SHUTDOWN connections as illustrated in the wiring diagram. Repeat the test and call technical support if the problem persists.
<input type="checkbox"/>	YES: Go to next step.	11	Open hood.
<input type="checkbox"/>	NO: Verify the remote programming, the RF connections and the wired door lock/unlock connections as illustrated in the wiring diagram, if applicable. Repeat the test and call technical support, if the problem persists.	12	If not already installed, affix the mandatory orange warning sticker under the hood and proceed to next step.
5	Press the TRUNK release button once [1x] on the aftermarket keyfob if supported.	13	Press the START/STOP button once [1x] on the aftermarket keyfob to remote start vehicle.
	Question 3: Does the trunk or hatch open/unlock?		Question 9: Does the vehicle remote start?
<input type="checkbox"/>	YES: Close trunk or hatch and go to next step.	<input type="checkbox"/>	YES: The vehicle is not equipped with a factory hood pin. Install a mandatory aftermarket hood switch, then repeat the test.
<input type="checkbox"/>	NO: Verify the remote programming, the RF connections and the wired trunk/hatch connections as illustrated in the wiring diagram, if applicable. Repeat the test and call technical support, if the problem persists.	<input type="checkbox"/>	NO: Go to next step.
6	Press the AUX 1 button once [1x] on the aftermarket keyfob if supported.	14	Close hood.
	Question 4: Does the driver side sliding door open?	15	Enter vehicle and close the doors.
<input type="checkbox"/>	YES: Press the AUX 1 button once [1x] to close the driver sliding door and go to next step.	16	Press the START/STOP button once [1x] on the aftermarket keyfob to remote start vehicle.
<input type="checkbox"/>	NO: Verify the remote programming and the RF connections. Repeat the test and call technical support, if the problem persists.	17	Wait for the vehicle to start.
7	Press the AUX 2 button once [1x] on the aftermarket keyfob if supported.	18	Press brake pedal.
	Question 5: Does the passenger side sliding door open?		Question 10: Does the vehicle shut down?
<input type="checkbox"/>	YES: Press the AUX 2 button once [1x] to close the passenger sliding door and go to next step.	<input type="checkbox"/>	YES: Go to next step.
<input type="checkbox"/>	NO: Verify the remote programming and the RF connections. Repeat the test and call technical support, if the problem persists.	<input type="checkbox"/>	NO: The module does NOT detect the brake pedal signal. Press the START/STOP button once [1x] on the aftermarket keyfob to shut down vehicle, check connection as illustrated in the wiring diagram, if applicable, and call technical support.
8	Press the START/STOP button once [1x] on the aftermarket keyfob to remote start vehicle.	19	Exit vehicle.
	Question 6: Does the vehicle remote start?	20	Installation checklist completed.
<input type="checkbox"/>	YES: Go to next step.		
<input type="checkbox"/>	NO: Verify the remote programming, the RF connections and check the remote start error codes. Repeat the test and call technical support, if the problem persists.		

CHECKLIST - WITH OEM KEYFOB

1	WARNING: Vehicle engine will start many times. Test in a well ventilated area.
2	Close all vehicle doors, hood and trunk.
3	Press LOCK button three times [3x] rapidly on the OEM keyfob to remote start vehicle.
	Question 1: Does the vehicle remote start?
<input type="checkbox"/>	YES: Go to next step.
<input type="checkbox"/>	NO: The module doesn't detect OEM remote lock button from the vehicle communication network. Check all connections, repeat the test and call technical support, if the problem persists.
4	Press LOCK button three times [3x] rapidly on the OEM keyfob to shut down vehicle.
	Question 2: Does the vehicle shut down?
<input type="checkbox"/>	YES: Go to next step.
<input type="checkbox"/>	NO: Repeat step. If the problem persists, press on the brake pedal once [1x] to shut down the vehicle and call technical support.
5	RAP Shutdown test
	Question 3: Did the radio, interior controls, and headlights turn off within 60 seconds after remote start shutdown?
<input type="checkbox"/>	YES: Go to next step.
<input type="checkbox"/>	NO: Verify the RAP SHUTDOWN connections as illustrated in the wiring diagram. Repeat the test and call technical support, if the problem persists.
6	Open hood.
7	If not already installed, affix the mandatory orange warning sticker under the hood and proceed to next step.
8	Press LOCK button three times [3x] rapidly on the OEM keyfob to remote start vehicle.
	Question 4: Does the vehicle remote start?
<input type="checkbox"/>	YES: The vehicle is not equipped with a factory hood pin. Install a mandatory aftermarket hood switch, then repeat the test.
<input type="checkbox"/>	NO: Go to next step.
9	Close hood.
10	Enter vehicle and close the doors.
11	Press LOCK button three times [3x] rapidly on the OEM keyfob to remote start vehicle.
12	Wait for the vehicle to start.
13	Press brake pedal.
	Question 5: Does the vehicle shut down?
<input type="checkbox"/>	YES: Go to next step.
<input type="checkbox"/>	NO: The module does NOT detect the brake pedal signal. Press LOCK button three times [3x] rapidly on the OEM keyfob to shut down, check the brake connection as illustrated in the wiring diagram, if applicable, and call technical support.
14	Exit vehicle.
15	Installation checklist completed.



INSTALL GUIDE

2016-2018 MAZDA CX-9 PTS AT



DOCUMENT NUMBER

REVISION DATE

20180829

FIRMWARE

ADS-RSA-MA3-[HCX000A]

HARDWARE

HCX000A

ACCESSORIES

ATTENTION: TO COMPLETE THIS INSTALLATION SOME ACCESSORIES MAY BE REQUIRED. VISIT OUR WEBSITE TO SEE ALL THE REQUIRED ACCESSORIES FOR YOUR VEHICLE.

TERMS OF USE

Automotive Data Solutions Inc. ("ADS") products are strictly intended for installation by Certified Technicians who are employed by a registered business specialized in the installation of automotive aftermarket electronics products. Prior to beginning installation of an ADS product in a vehicle, it is the Certified Technician's responsibility to review the most current Product Guide, Install Guide and vehicle-specific notes available in Weblink®. ADS is not responsible for any damages whatsoever, including but not limited to any consequential damages, incidental damages, damages for loss of time, loss of earnings, loss of profit, commercial loss, loss of economic opportunity and the like that may or may not have resulted from the use, misuse, improper installation or operation of its products. ADS reserves itself the right to suspend any Weblink® account without notice and decline to offer technical support to non-Certified Technicians, non-compliant Certified Technicians or end users.

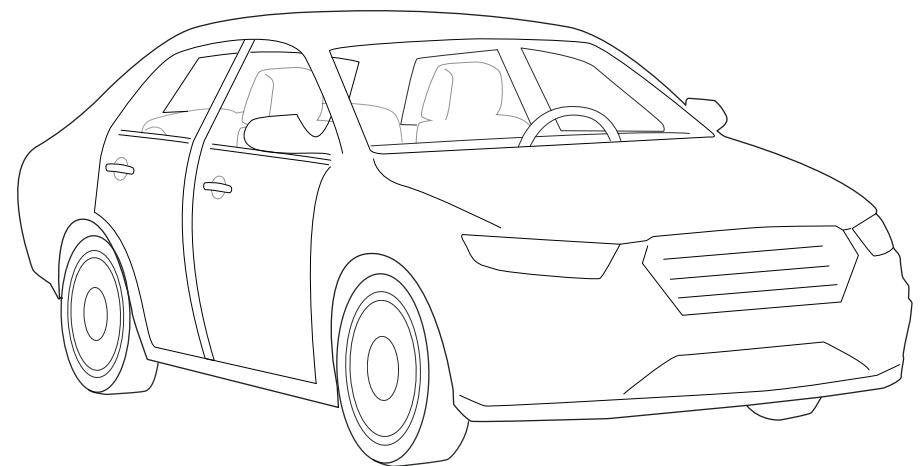
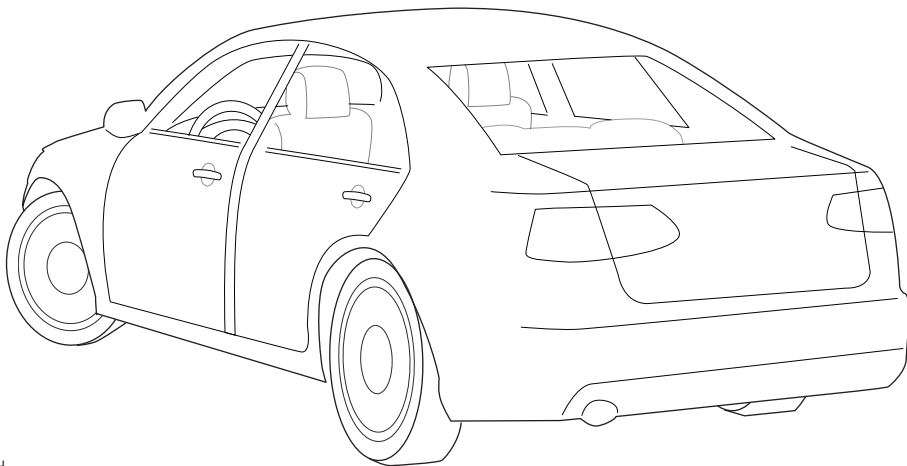
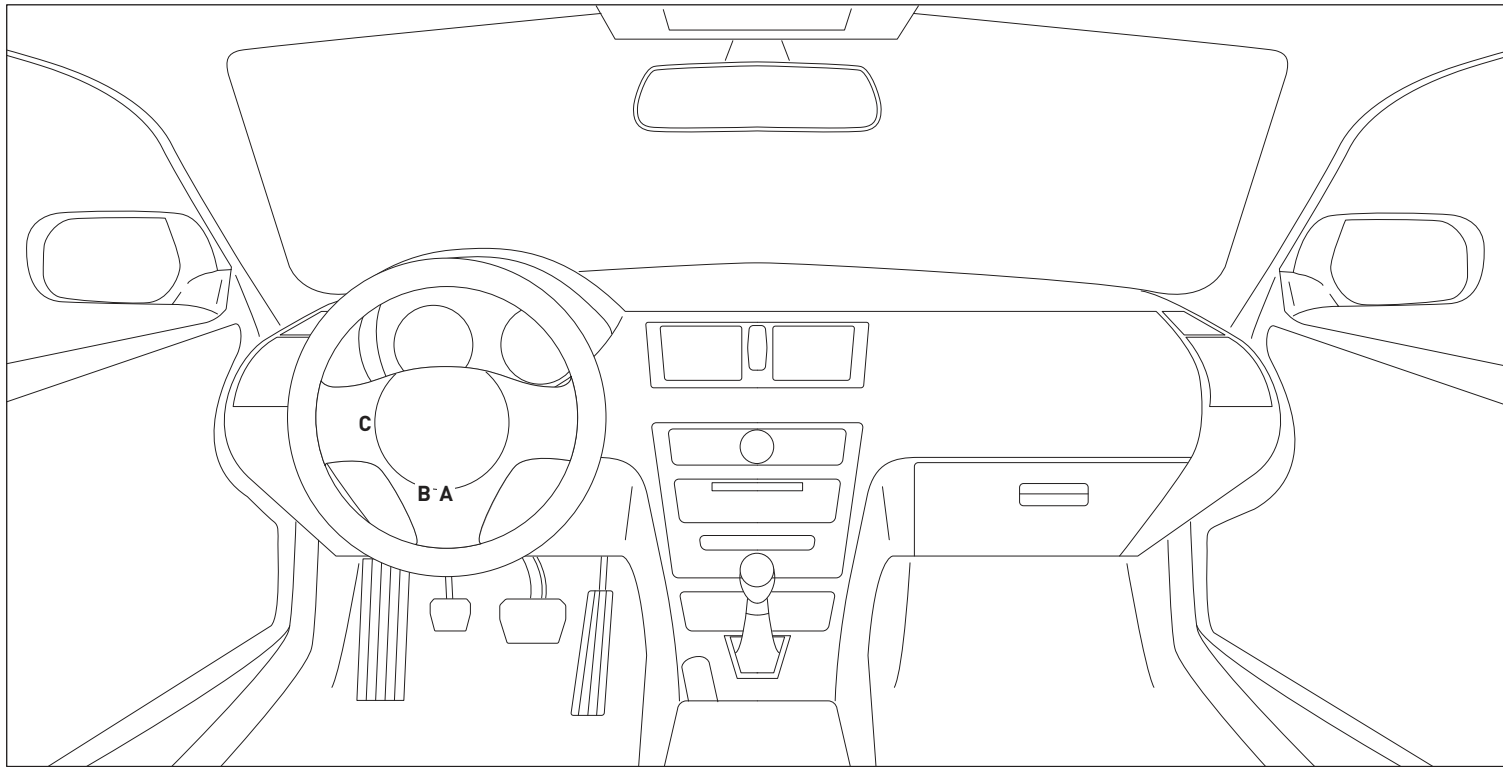

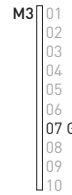
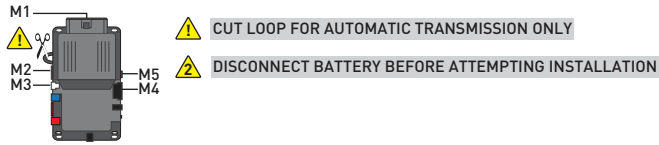

GRAY•BLUE DOT
GRAY/RED•BLUE DOT
GRAY/BLACK•BLUE DOT

07 GRAY•SILVER DOT - HOOD STATUS (-) INPUT

MS1

MS2

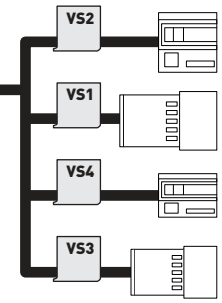

HORN (-) WHITE/BLACK - 01

10 WHITE/BLACK•BLACK DOT - HORN (-) OUTPUT

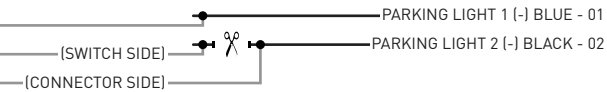

PARKING LIGHT 1 (-) BLUE - 01

PARKING LIGHT 2 (-) BLACK - 02

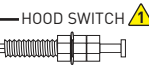

HOOD SWITCH ⚠

⚠ INSTALL THE SUPPLIED HOOD SWITCH IF THE VEHICLE IS NOT EQUIPPED WITH ONE
SET THE PROGRAMMING OPTION THROUGH WEBLINK AS FOLLOWS:
IN "MENU #7 INPUTS CONFIGURATION",
FOR "4-HOOD INPUT SOURCE" SELECT "1-ANALOG".

START STOP UNIT, UNDER STEERING COLUMN (A)

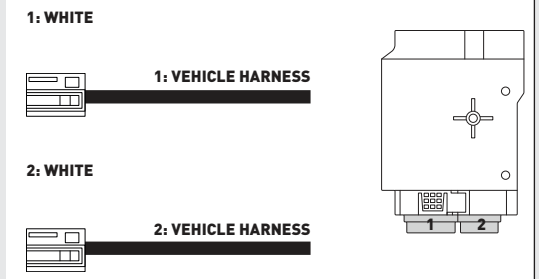

CLOCK SPRING (B)

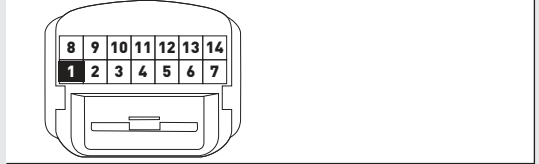

PARKING LIGHTS SWITCH, LEFT OF STEERING COLUMN (C)

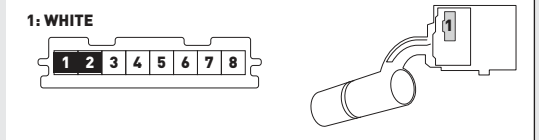

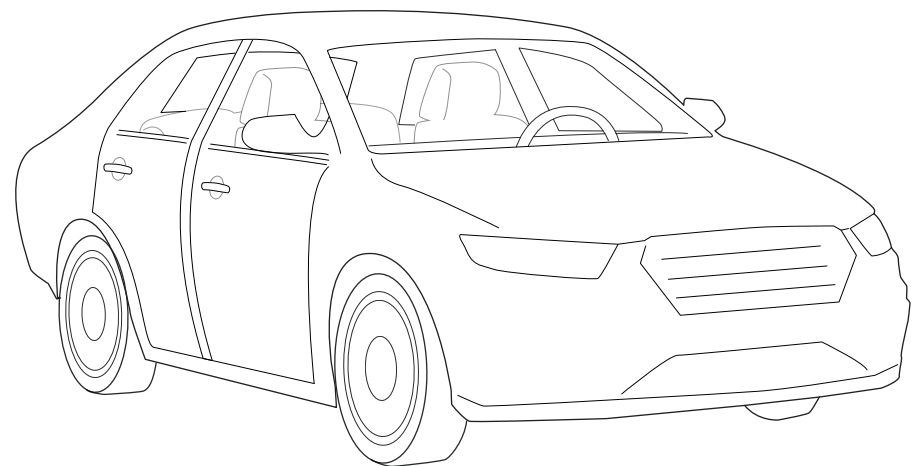
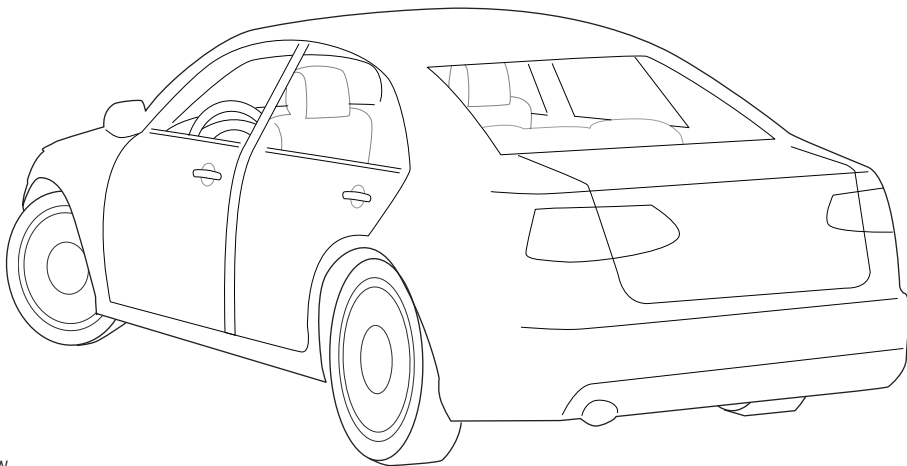
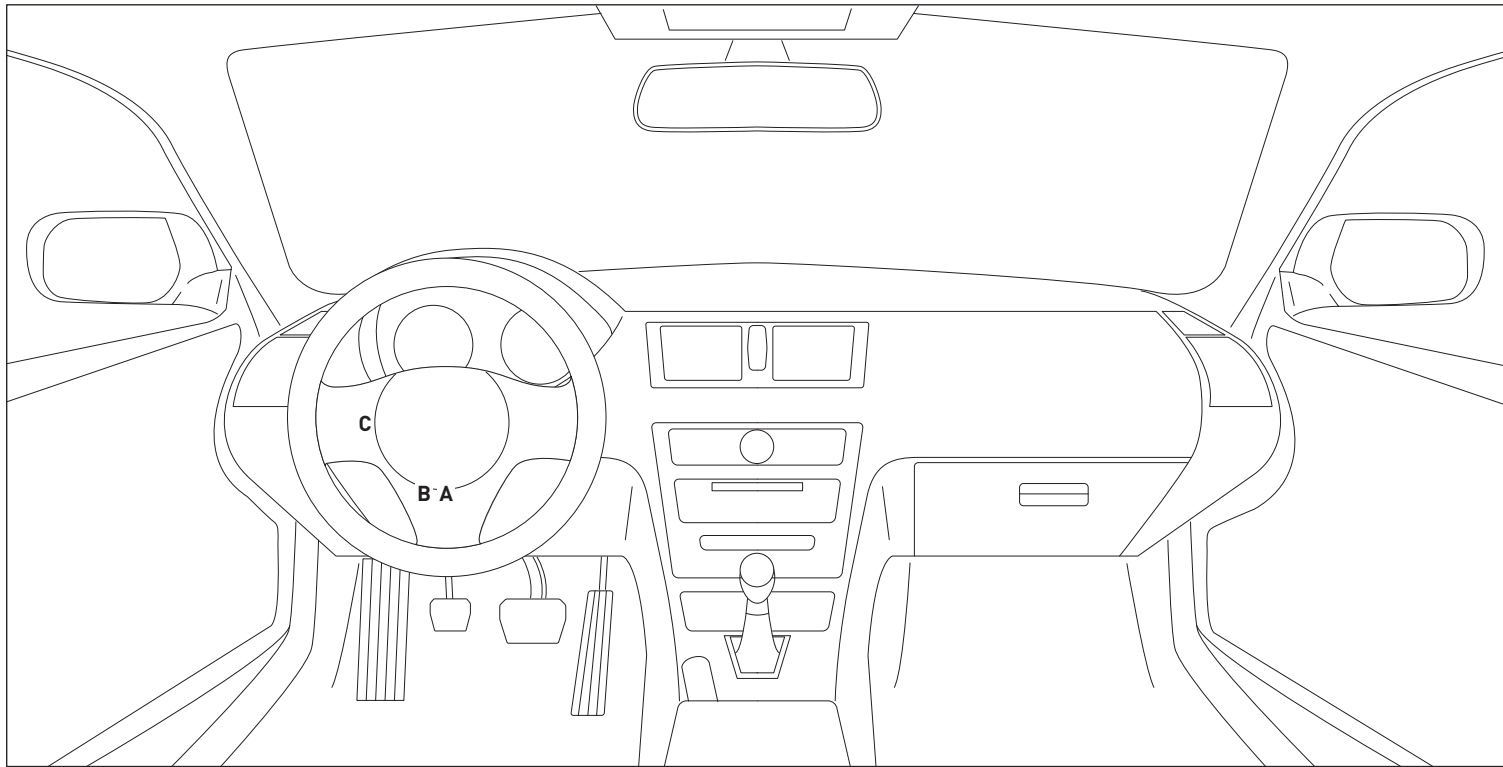

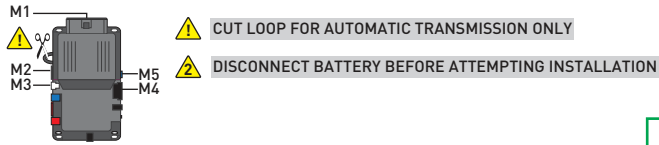

- CUT LOOP FOR AUTOMATIC TRANSMISSION ONLY
- DISCONNECT BATTERY BEFORE ATTEMPTING INSTALLATION

- M1**
- 01 ORANGE
 - 02 RED
 - 03 PURPLE
 - 04 PINK/WHITE
 - 05 PINK
 - 06 WHITE
 - 07 RED
 - 08 BLACK
- M2**
- 01 GREEN•BLACK DOT
 - 02 BLUE•BLACK DOT
 - 03 RED/WHITE•BLACK DOT
 - 04 GREEN/WHITE•BLACK DOT
 - 05 GREEN/BLACK•BLACK DOT
 - 06 BLUE/WHITE•BLACK DOT
 - 07 EMPTY
 - 08 WHITE/PURPLE•BLACK DOT
 - 09 PURPLE/BLACK•BLACK DOT
 - 10 WHITE/BLACK•BLACK DOT - HORN (-) OUTPUT
 - 11 BROWN/BLACK•BLACK DOT
 - 12 WHITE•BLACK DOT
- M3**
- 01 BROWN•SILVER DOT
 - 02 BLACK/WHITE•SILVER DOT
 - 03 PURPLE•SILVER DOT
 - 04 GREEN•SILVER DOT
 - 05 PURPLE/WHITE•SILVER DOT
 - 06 WHITE/BLUE•SILVER DOT
 - 07 GRAY•SILVER DOT - HOOD STATUS (-) INPUT
 - 08 BLUE•SILVER DOT
 - 09 GRAY/BLACK•SILVER DOT
 - 10 EMPTY
- M4**
- 01 EMPTY
 - 02 EMPTY
 - 03 BROWN/RED - CANH 1
 - 04 BROWN/YELLOW - CANL 1
 - 05 BLUE/RED
 - 06 BLUE/YELLOW
 - 07 EMPTY
 - 08 ORANGE
 - 09 YELLOW
 - 10 EMPTY
 - 11 GRAY/RED - PTS (-) OUTPUT
 - 12 GRAY/YELLOW
 - 13 GREEN/RED - KEYLESS (DATA)
 - 14 ORANGE/WHITE
 - 15 BROWN - ACCESSORY (+) IN/OUT
 - 16 ORANGE/BLACK
 - 17 PINK - IGNITION (+) IN/OUT
 - 18 PURPLE - STARTER (+) OUTPUT
 - 19 RED - 12V (+) INPUT
 - 20 BLACK - GROUND (-)
- M5**
- 01 GRAY/BLACK•BLUE DOT - PARKING LIGHT 2 (-) CONNECTOR SIDE
 - 02 WHITE/BLACK•BLUE DOT - IGNITION 2 (+)
 - 03 GRAY/RED•BLUE DOT DOTDOT - PARKING LIGHT 2 (-) SWITCH SIDE
 - 04 WHITE/RED•BLUE - IGNITION 2 (+)
 - 05 GRAY•BLUE DOT - PARKING LIGHT 1 (-) OUTPUT
 - 06 WHITE•BLUE

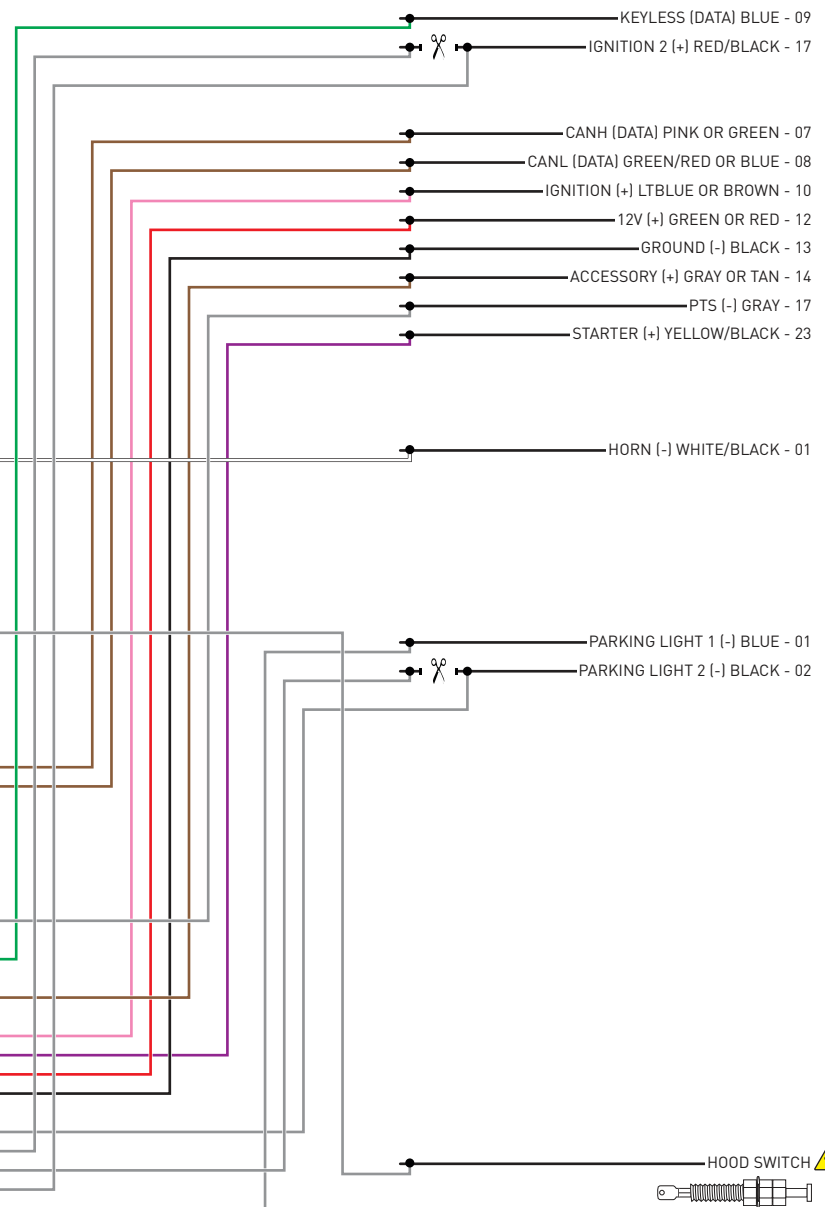

START STOP UNIT, UNDER STEERING COLUMN (A)

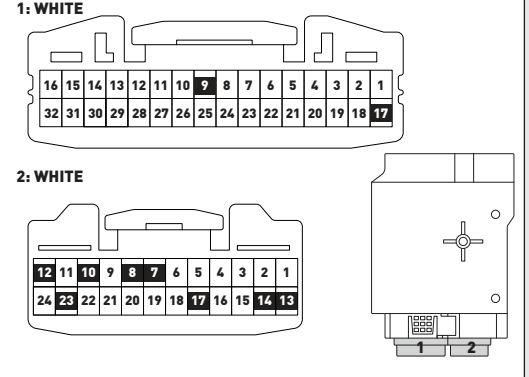

CLOCK SPRING (B)

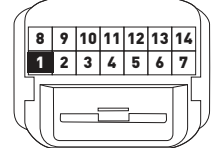

PARKING LIGHTS SWITCH, LEFT OF STEERING COLUMN (C)

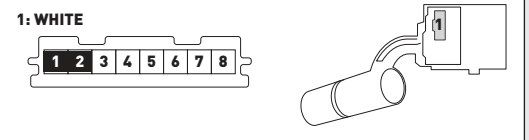



INSTALL THE SUPPLIED HOOD SWITCH IF THE VEHICLE IS NOT EQUIPPED WITH ONE SET THE PROGRAMMING OPTION THROUGH WEBLINK AS FOLLOWS:
IN "MENU #7 INPUTS CONFIGURATION", FOR "4-HOOD INPUT SOURCE" SELECT "1-ANALOG".

>>  WARNING: All vehicle doors must be closed and locked prior to remote start sequence.

01  Set ignition to ON position.

02  Wait, LED 1 will turn solid RED to confirm that the ignition is ON.

03  Wait 10 seconds, LED 1 will flash GREEN rapidly.

04  Set ignition to OFF position.

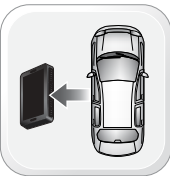
05  WARNING: Disconnect power last. Disconnect module from vehicle.

06  Connect module to computer and proceed with extended programming.

07  Connect power first. Connect module to vehicle.

08  Set ignition to ON position.

09  Wait, LED 1 will turn solid RED to confirm that the ignition is ON.

10  Wait, LED 1 will turn solid GREEN for 2 seconds.

11  Set ignition to OFF position.

>>  If vehicle is equipped with power liftgate: open and close the power liftgate with OEM keyfob.

12  START vehicle for 15 seconds.

13  Press and hold the brake pedal.

14  Press and release the module's programming button.

15  Release the brake pedal.

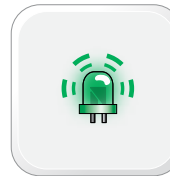
16  Wait, LED 2 will flash GREEN. Module Programming Procedure completed.

>>



All vehicle doors must be closed and locked prior to remote start sequence.

01



Time restriction. Complete steps 2 to 5 within 45 seconds.

02



Press unlock on OEM or aftermarket remote or request switch.

03



Open driver door and enter vehicle.

04



Close driver door.

05



Press and release BRAKE pedal.

06



Take over procedure completed.

>>



Failure to follow procedure will result in vehicle engine shutdown.

CHECKLIST - WITH AFTERMARKET KEYFOB

1	WARNING: Vehicle engine will start many times. Test in a well ventilated area.	9	Press the START/STOP button once [1x] on the aftermarket keyfob to shut down vehicle.
2	Close all vehicle doors, hood and trunk.		Question 7: Does the vehicle shut down?
3	Press the LOCK button once [1x] on the aftermarket keyfob.	<input type="checkbox"/>	YES: Go to next step.
	Question 1: Do the doors lock?	<input type="checkbox"/>	NO: Repeat step. If problem persists, press the brake pedal once [1x] to shut down the vehicle and call technical support.
<input type="checkbox"/>	YES: Go to next step.	10	RAP and auto light shutdown test
<input type="checkbox"/>	NO: Verify the remote programming, the RF connections and the wired door lock/unlock connections as illustrated in the wiring diagram, if applicable. Repeat the test and call technical support, if the problem persists.		Question 8: Did the radio, interior controls and headlights turn off within 60 seconds after remote start shutdown?
4	Press the UNLOCK button once [1x] on the aftermarket keyfob.	<input type="checkbox"/>	YES: Go to next step.
	Question 2: Do the doors unlock?	<input type="checkbox"/>	NO: Verify the RAP SHUTDOWN connections as illustrated in the wiring diagram. Repeat the test and call technical support if the problem persists.
<input type="checkbox"/>	YES: Go to next step.	11	Open hood.
<input type="checkbox"/>	NO: Verify the remote programming, the RF connections and the wired door lock/unlock connections as illustrated in the wiring diagram, if applicable. Repeat the test and call technical support, if the problem persists.	12	If not already installed, affix the mandatory orange warning sticker under the hood and proceed to next step.
5	Press the TRUNK release button once [1x] on the aftermarket keyfob if supported.	13	Press the START/STOP button once [1x] on the aftermarket keyfob to remote start vehicle.
	Question 3: Does the trunk or hatch open/unlock?		Question 9: Does the vehicle remote start?
<input type="checkbox"/>	YES: Close trunk or hatch and go to next step.	<input type="checkbox"/>	YES: The vehicle is not equipped with a factory hood pin. Install a mandatory aftermarket hood switch, then repeat the test.
<input type="checkbox"/>	NO: Verify the remote programming, the RF connections and the wired trunk/hatch connections as illustrated in the wiring diagram, if applicable. Repeat the test and call technical support, if the problem persists.	<input type="checkbox"/>	NO: Go to next step.
6	Press the AUX 1 button once [1x] on the aftermarket keyfob if supported.	14	Close hood.
	Question 4: Does the driver side sliding door open?	15	Enter vehicle and close the doors.
<input type="checkbox"/>	YES: Press the AUX 1 button once [1x] to close the driver sliding door and go to next step.	16	Press the START/STOP button once [1x] on the aftermarket keyfob to remote start vehicle.
<input type="checkbox"/>	NO: Verify the remote programming and the RF connections. Repeat the test and call technical support, if the problem persists.	17	Wait for the vehicle to start.
7	Press the AUX 2 button once [1x] on the aftermarket keyfob if supported.	18	Press brake pedal.
	Question 5: Does the passenger side sliding door open?		Question 10: Does the vehicle shut down?
<input type="checkbox"/>	YES: Press the AUX 2 button once [1x] to close the passenger sliding door and go to next step.	<input type="checkbox"/>	YES: Go to next step.
<input type="checkbox"/>	NO: Verify the remote programming and the RF connections. Repeat the test and call technical support, if the problem persists.	<input type="checkbox"/>	NO: The module does NOT detect the brake pedal signal. Press the START/STOP button once [1x] on the aftermarket keyfob to shut down vehicle, check connection as illustrated in the wiring diagram, if applicable, and call technical support.
8	Press the START/STOP button once [1x] on the aftermarket keyfob to remote start vehicle.	19	Exit vehicle.
	Question 6: Does the vehicle remote start?	20	Installation checklist completed.
<input type="checkbox"/>	YES: Go to next step.		
<input type="checkbox"/>	NO: Verify the remote programming, the RF connections and check the remote start error codes. Repeat the test and call technical support, if the problem persists.		

CHECKLIST - WITH OEM KEYFOB

1	WARNING: Vehicle engine will start many times. Test in a well ventilated area.
2	Close all vehicle doors, hood and trunk.
3	Press LOCK button three times [3x] rapidly on the OEM keyfob to remote start vehicle.
	Question 1: Does the vehicle remote start?
<input type="checkbox"/>	YES: Go to next step.
<input type="checkbox"/>	NO: The module doesn't detect OEM remote lock button from the vehicle communication network. Check all connections, repeat the test and call technical support, if the problem persists.
4	Press LOCK button three times [3x] rapidly on the OEM keyfob to shut down vehicle.
	Question 2: Does the vehicle shut down?
<input type="checkbox"/>	YES: Go to next step.
<input type="checkbox"/>	NO: Repeat step. If the problem persists, press on the brake pedal once [1x] to shut down the vehicle and call technical support.
5	RAP Shutdown test
	Question 3: Did the radio, interior controls, and headlights turn off within 60 seconds after remote start shutdown?
<input type="checkbox"/>	YES: Go to next step.
<input type="checkbox"/>	NO: Verify the RAP SHUTDOWN connections as illustrated in the wiring diagram. Repeat the test and call technical support, if the problem persists.
6	Open hood.
7	If not already installed, affix the mandatory orange warning sticker under the hood and proceed to next step.
8	Press LOCK button three times [3x] rapidly on the OEM keyfob to remote start vehicle.
	Question 4: Does the vehicle remote start?
<input type="checkbox"/>	YES: The vehicle is not equipped with a factory hood pin. Install a mandatory aftermarket hood switch, then repeat the test.
<input type="checkbox"/>	NO: Go to next step.
9	Close hood.
10	Enter vehicle and close the doors.
11	Press LOCK button three times [3x] rapidly on the OEM keyfob to remote start vehicle.
12	Wait for the vehicle to start.
13	Press brake pedal.
	Question 5: Does the vehicle shut down?
<input type="checkbox"/>	YES: Go to next step.
<input type="checkbox"/>	NO: The module does NOT detect the brake pedal signal. Press LOCK button three times [3x] rapidly on the OEM keyfob to shut down, check the brake connection as illustrated in the wiring diagram, if applicable, and call technical support.
14	Exit vehicle.
15	Installation checklist completed.



INSTALL GUIDE

2016-2018 MAZDA MX-5 PTS AT

DOCUMENT NUMBER

REVISION DATE

20180829

FIRMWARE

ADS-RSA-MA3-[HCX000A]

HARDWARE

HCX000A

ACCESSORIES

ATTENTION: TO COMPLETE THIS INSTALLATION SOME ACCESSORIES MAY BE REQUIRED. VISIT OUR WEBSITE TO SEE ALL THE REQUIRED ACCESSORIES FOR YOUR VEHICLE.

TERMS OF USE

Automotive Data Solutions Inc. ("ADS") products are strictly intended for installation by Certified Technicians who are employed by a registered business specialized in the installation of automotive aftermarket electronics products. Prior to beginning installation of an ADS product in a vehicle, it is the Certified Technician's responsibility to review the most current Product Guide, Install Guide and vehicle-specific notes available in Weblink®. ADS is not responsible for any damages whatsoever, including but not limited to any consequential damages, incidental damages, damages for loss of time, loss of earnings, loss of profit, commercial loss, loss of economic opportunity and the like that may or may not have resulted from the use, misuse, improper installation or operation of its products. ADS reserves itself the right to suspend any Weblink® account without notice and decline to offer technical support to non-Certified Technicians, non-compliant Certified Technicians or end users.



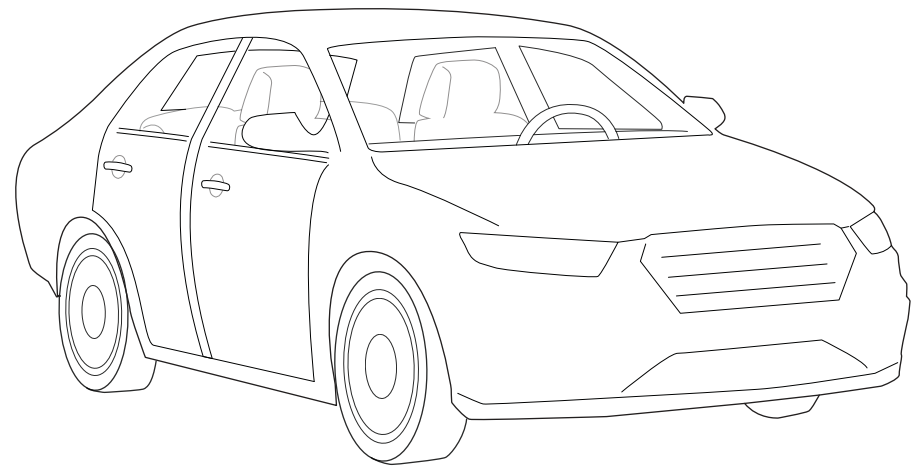
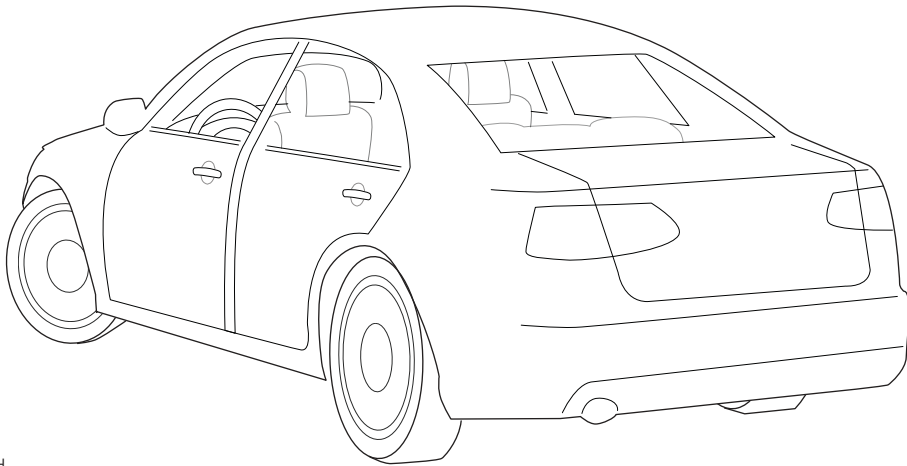
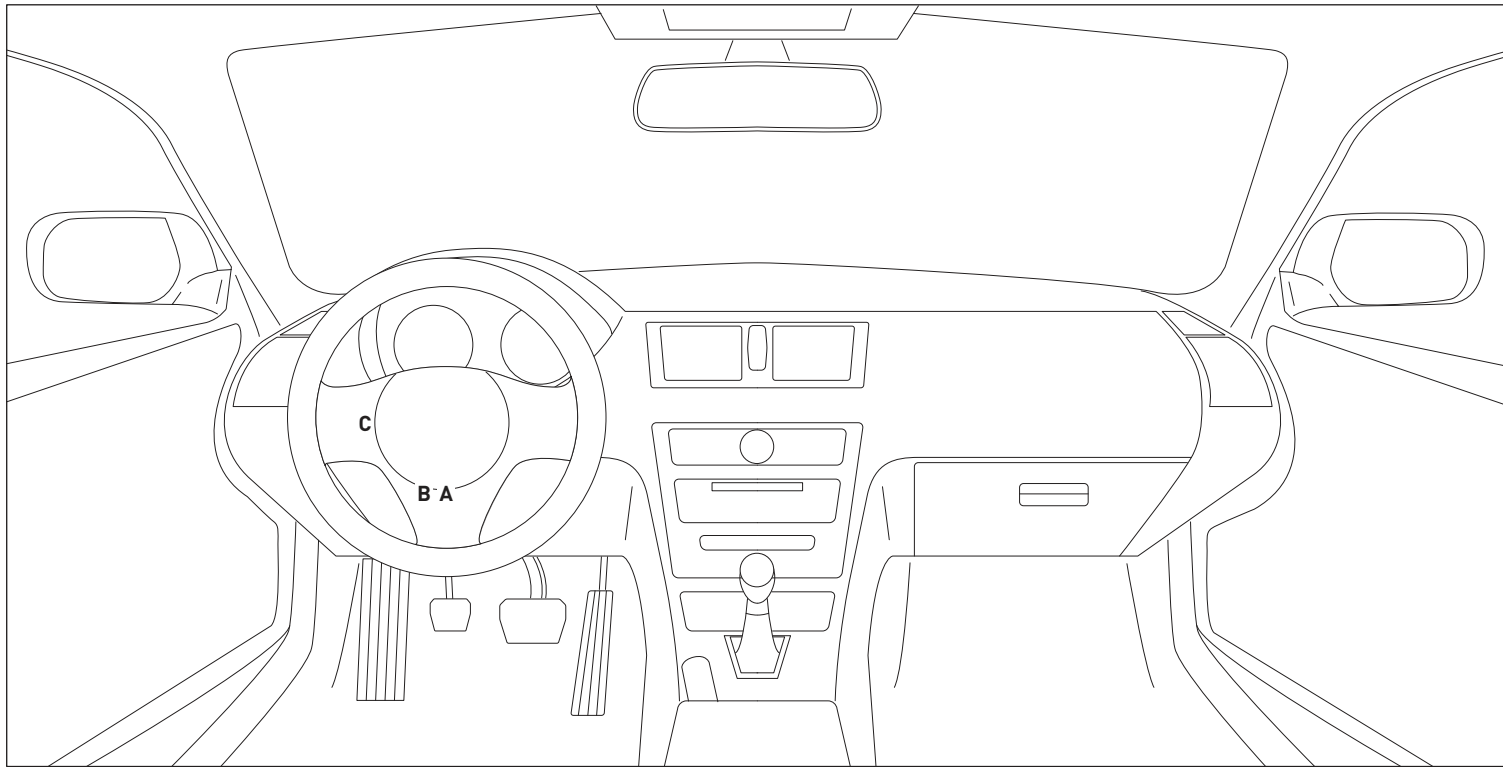

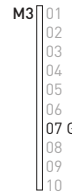
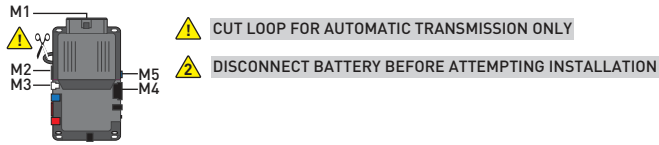

MS1



MS2

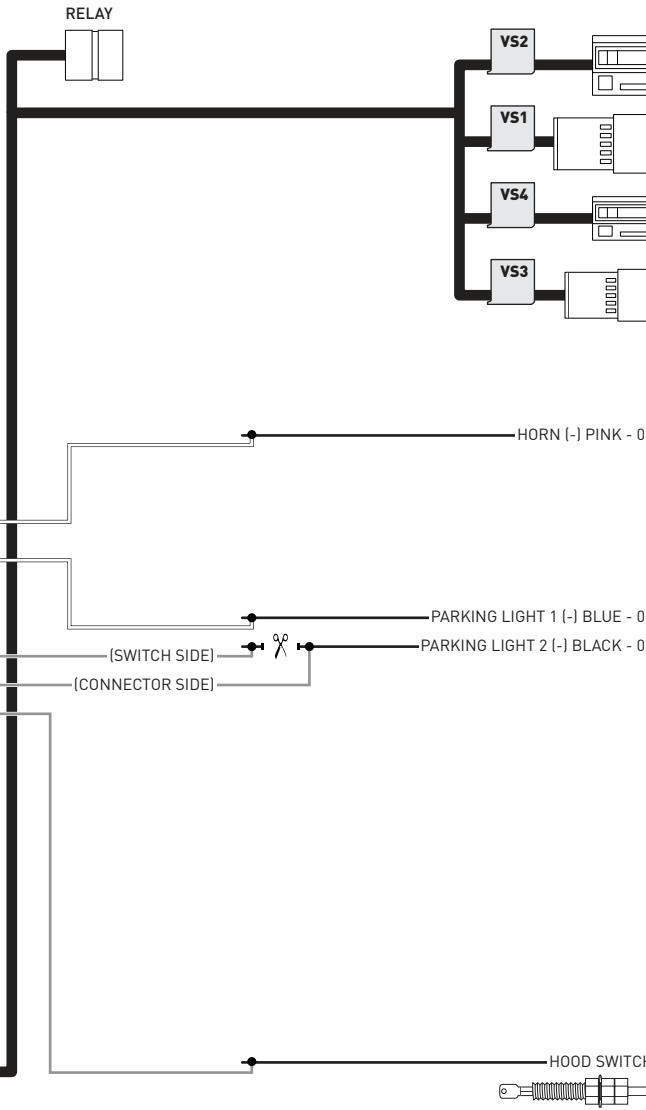

⚠ INSTALL THE SUPPLIED HOOD SWITCH **⚠**
IF THE VEHICLE IS NOT EQUIPPED WITH ONE
SET THE PROGRAMMING OPTION THROUGH WEBLINK AS FOLLOWS:
IN "MENU #7 INPUTS CONFIGURATION",
FOR "4-HOOD INPUT SOURCE" SELECT "1-ANALOG".

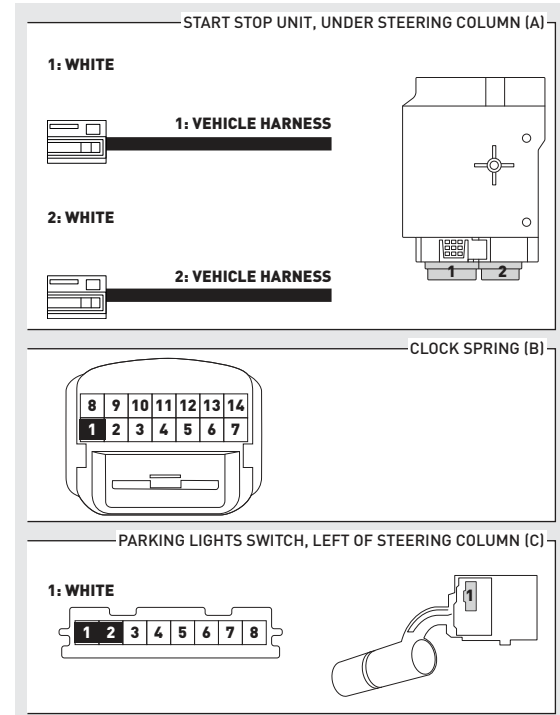

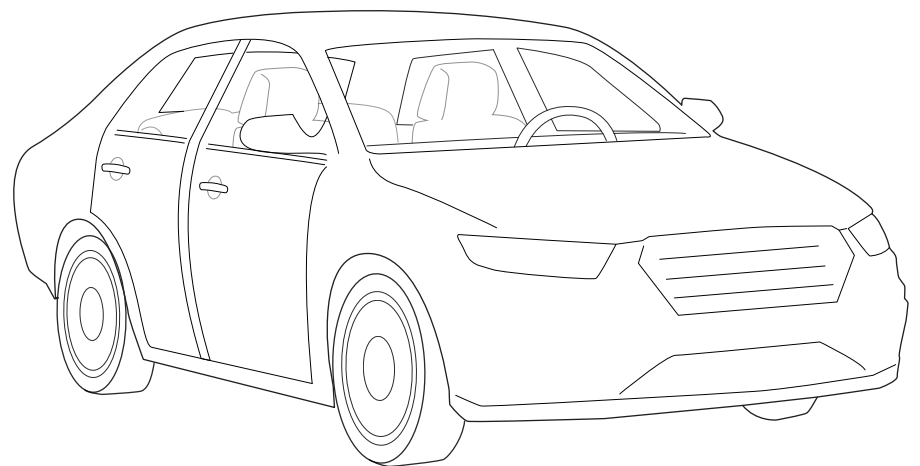
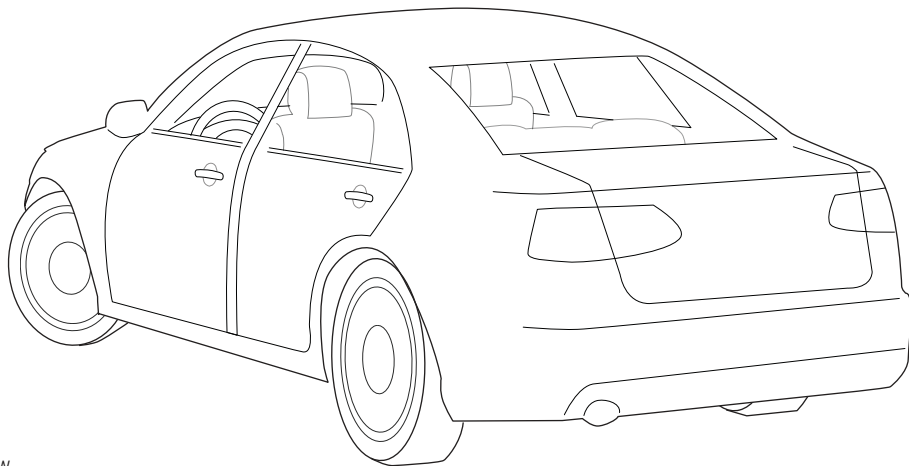
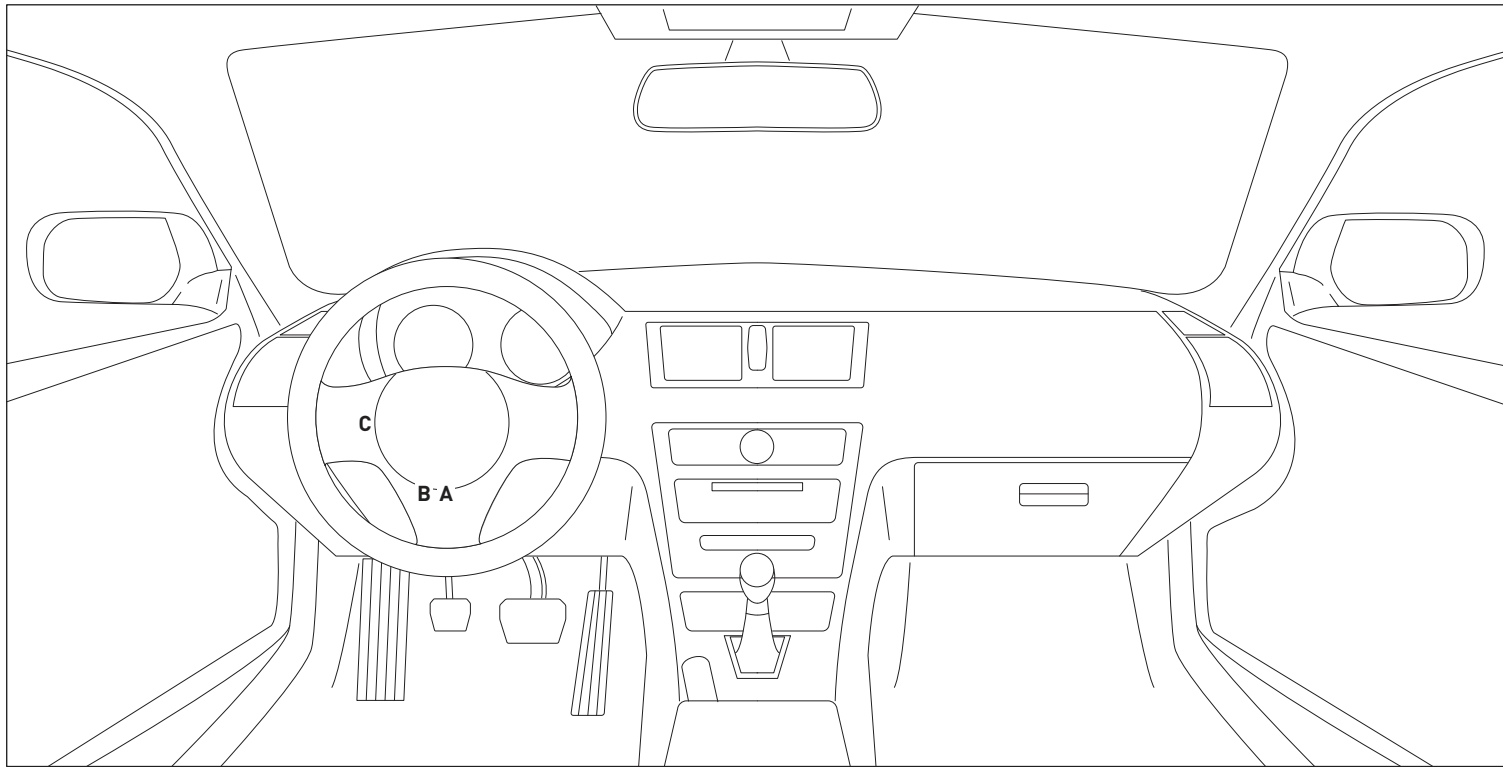

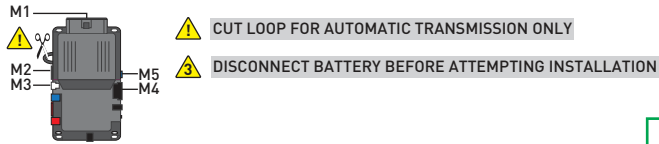

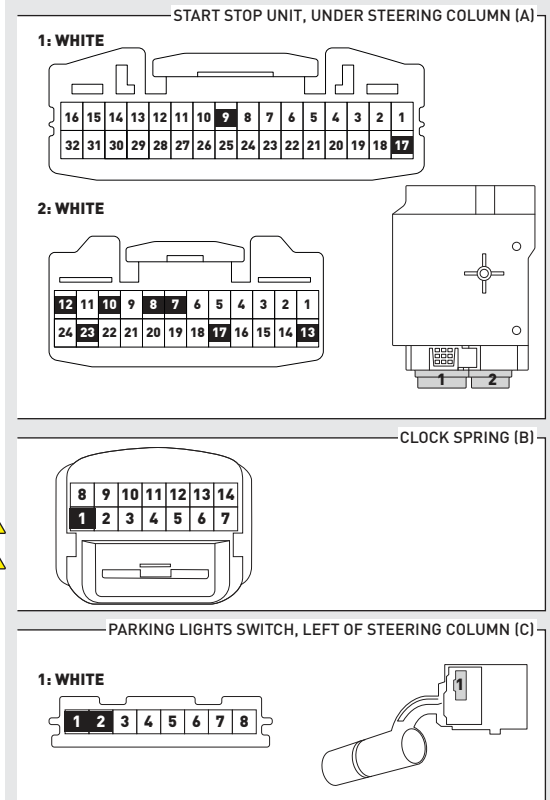
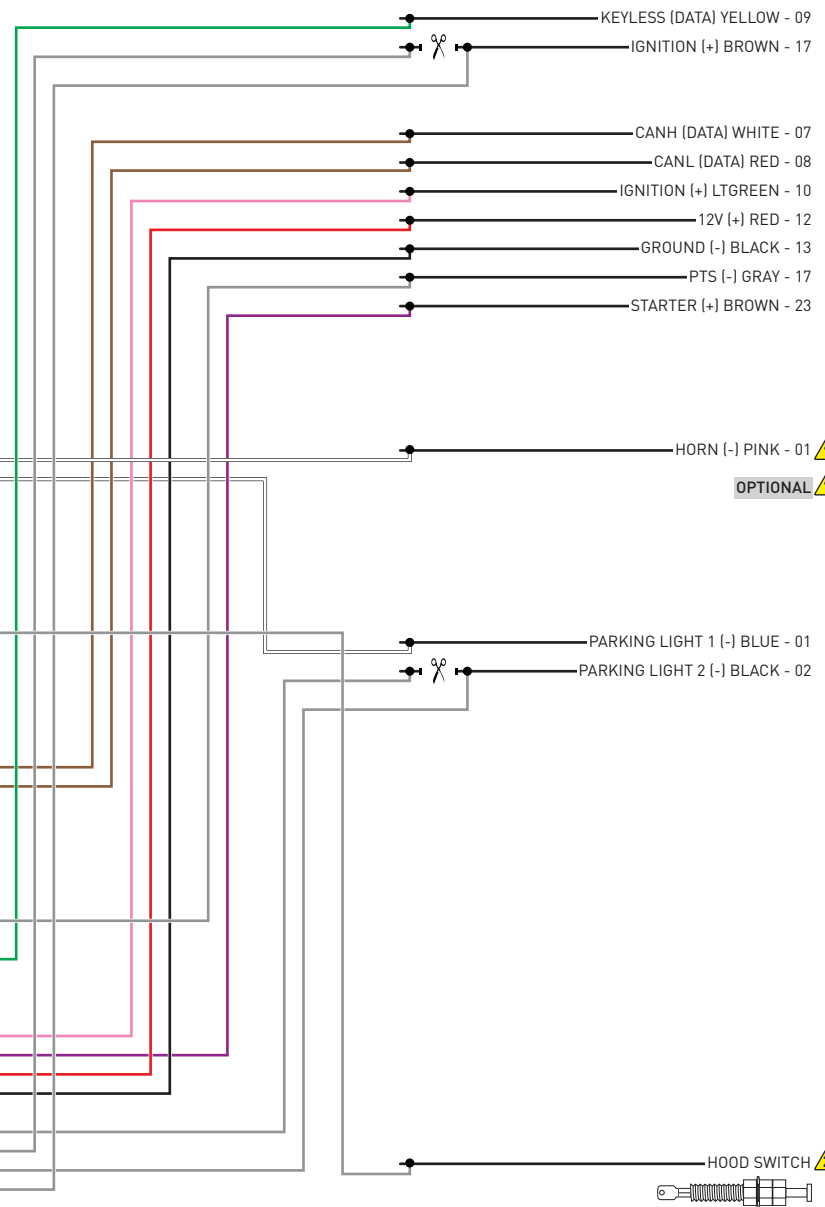

- M1**
 - 01 ORANGE
 - 02 RED
 - 03 PURPLE
 - 04 PINK/WHITE
 - 05 PINK
 - 06 WHITE
 - 07 RED
 - 08 BLACK
- M2**
 - 01 GREEN•BLACK DOT
 - 02 BLUE•BLACK DOT
 - 03 RED/WHITE•BLACK DOT
 - 04 GREEN/WHITE•BLACK DOT
 - 05 GREEN/BLACK•BLACK DOT
 - 06 BLUE/WHITE•BLACK DOT
 - 07 EMPTY
 - 08 WHITE/PURPLE•BLACK DOT
 - 09 PURPLE/BLACK•BLACK DOT
 - 10 WHITE/BLACK•BLACK DOT - HORN (-) OUTPUT
 - 11 BROWN/BLACK•BLACK DOT
 - 12 WHITE•BLACK DOT - PARKING LIGHT 1 (-) OUTPUT
- M3**
 - 01 BROWN•SILVER DOT
 - 02 BLACK/WHITE•SILVER DOT
 - 03 PURPLE•SILVER DOT
 - 04 GREEN•SILVER DOT
 - 05 PURPLE/WHITE•SILVER DOT
 - 06 WHITE/BLUE•SILVER DOT
 - 07 GRAY•SILVER DOT - HOOD STATUS (-) INPUT
 - 08 BLUE•SILVER DOT
 - 09 GRAY/BLACK•SILVER DOT
 - 10 EMPTY
- M4**
 - 01 EMPTY
 - 02 EMPTY
 - 03 BROWN/RED - CANH 1
 - 04 BROWN/YELLOW - CANL 1
 - 05 BLUE/RED
 - 06 BLUE/YELLOW
 - 07 EMPTY
 - 08 ORANGE
 - 09 YELLOW
 - 10 EMPTY
 - 11 GRAY/RED - PTS (-) OUTPUT
 - 12 GRAY/YELLOW
 - 13 GREEN/RED - KEYLESS (DATA)
 - 14 ORANGE/WHITE
 - 15 BROWN
 - 16 ORANGE/BLACK
 - 17 PINK - IGNITION (+) IN/OUT
 - 18 PURPLE - STARTER (+) OUTPUT
 - 19 RED - 12V (+) INPUT
 - 20 BLACK - GROUND (-)
- M5**
 - 01 GRAY/BLACK•BLUE DOT - PARKING LIGHT 2 (-) SWITCH SIDE
 - 02 WHITE/BLACK•BLUE DOT - IGNITION (+)
 - 03 GRAY/RED•BLUE DOT - PARKING LIGHT 2 (-) CONNECTOR SIDE
 - 04 WHITE/RED•BLUE DOT - IGNITION (+)
 - 05 GRAY•BLUE DOT
 - 06 WHITE•BLUE



⚠ INSTALL THE SUPPLIED HOOD SWITCH IF THE VEHICLE IS NOT EQUIPPED WITH ONE
⚠ SET THE PROGRAMMING OPTION THROUGH WEBLINK AS FOLLOWS:
 IN "MENU #7 INPUTS CONFIGURATION",
 FOR "4-HOOD INPUT SOURCE" SELECT "1-ANALOG".

>>  WARNING: All vehicle doors must be closed and locked prior to remote start sequence.

01  Set ignition to ON position.

02  Wait, LED 1 will turn solid RED to confirm that the ignition is ON.

03  Wait 10 seconds, LED 1 will flash GREEN rapidly.

04  Set ignition to OFF position.

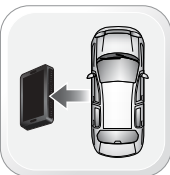
05  WARNING: Disconnect power last. Disconnect module from vehicle.

06  Connect module to computer and proceed with extended programming.

07  Connect power first. Connect module to vehicle.

08  Set ignition to ON position.

09  Wait, LED 1 will turn solid RED to confirm that the ignition is ON.

10  Wait, LED 1 will turn solid GREEN for 2 seconds.

11  Set ignition to OFF position.

>>  If vehicle is equipped with power liftgate: open and close the power liftgate with OEM keyfob.

12  START vehicle for 15 seconds.

13  Press and hold the brake pedal.

14  Press and release the module's programming button.

15  Release the brake pedal.

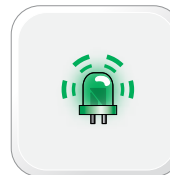
16  Wait, LED 2 will flash GREEN. Module Programming Procedure completed.

>>



All vehicle doors must be closed and locked prior to remote start sequence.

01



Time restriction. Complete steps 2 to 5 within 45 seconds.

02



Press unlock on OEM or aftermarket remote or request switch.

03



Open driver door and enter vehicle.

04



Close driver door.

05



Press and release BRAKE pedal.

06



Take over procedure completed.

>>



Failure to follow procedure will result in vehicle engine shutdown.

CHECKLIST - WITH AFTERMARKET KEYFOB

1	WARNING: Vehicle engine will start many times. Test in a well ventilated area.	9	Press the START/STOP button once [1x] on the aftermarket keyfob to shut down vehicle.
2	Close all vehicle doors, hood and trunk.		Question 7: Does the vehicle shut down?
3	Press the LOCK button once [1x] on the aftermarket keyfob.	<input type="checkbox"/>	YES: Go to next step.
	Question 1: Do the doors lock?	<input type="checkbox"/>	NO: Repeat step. If problem persists, press the brake pedal once [1x] to shut down the vehicle and call technical support.
<input type="checkbox"/>	YES: Go to next step.	10	RAP and auto light shutdown test
<input type="checkbox"/>	NO: Verify the remote programming, the RF connections and the wired door lock/unlock connections as illustrated in the wiring diagram, if applicable. Repeat the test and call technical support, if the problem persists.		Question 8: Did the radio, interior controls and headlights turn off within 60 seconds after remote start shutdown?
4	Press the UNLOCK button once [1x] on the aftermarket keyfob.	<input type="checkbox"/>	YES: Go to next step.
	Question 2: Do the doors unlock?	<input type="checkbox"/>	NO: Verify the RAP SHUTDOWN connections as illustrated in the wiring diagram. Repeat the test and call technical support if the problem persists.
<input type="checkbox"/>	YES: Go to next step.	11	Open hood.
<input type="checkbox"/>	NO: Verify the remote programming, the RF connections and the wired door lock/unlock connections as illustrated in the wiring diagram, if applicable. Repeat the test and call technical support, if the problem persists.	12	If not already installed, affix the mandatory orange warning sticker under the hood and proceed to next step.
5	Press the TRUNK release button once [1x] on the aftermarket keyfob if supported.	13	Press the START/STOP button once [1x] on the aftermarket keyfob to remote start vehicle.
	Question 3: Does the trunk or hatch open/unlock?		Question 9: Does the vehicle remote start?
<input type="checkbox"/>	YES: Close trunk or hatch and go to next step.	<input type="checkbox"/>	YES: The vehicle is not equipped with a factory hood pin. Install a mandatory aftermarket hood switch, then repeat the test.
<input type="checkbox"/>	NO: Verify the remote programming, the RF connections and the wired trunk/hatch connections as illustrated in the wiring diagram, if applicable. Repeat the test and call technical support, if the problem persists.	<input type="checkbox"/>	NO: Go to next step.
6	Press the AUX 1 button once [1x] on the aftermarket keyfob if supported.	14	Close hood.
	Question 4: Does the driver side sliding door open?	15	Enter vehicle and close the doors.
<input type="checkbox"/>	YES: Press the AUX 1 button once [1x] to close the driver sliding door and go to next step.	16	Press the START/STOP button once [1x] on the aftermarket keyfob to remote start vehicle.
<input type="checkbox"/>	NO: Verify the remote programming and the RF connections. Repeat the test and call technical support, if the problem persists.	17	Wait for the vehicle to start.
7	Press the AUX 2 button once [1x] on the aftermarket keyfob if supported.	18	Press brake pedal.
	Question 5: Does the passenger side sliding door open?		Question 10: Does the vehicle shut down?
<input type="checkbox"/>	YES: Press the AUX 2 button once [1x] to close the passenger sliding door and go to next step.	<input type="checkbox"/>	YES: Go to next step.
<input type="checkbox"/>	NO: Verify the remote programming and the RF connections. Repeat the test and call technical support, if the problem persists.	<input type="checkbox"/>	NO: The module does NOT detect the brake pedal signal. Press the START/STOP button once [1x] on the aftermarket keyfob to shut down vehicle, check connection as illustrated in the wiring diagram, if applicable, and call technical support.
8	Press the START/STOP button once [1x] on the aftermarket keyfob to remote start vehicle.	19	Exit vehicle.
	Question 6: Does the vehicle remote start?	20	Installation checklist completed.
<input type="checkbox"/>	YES: Go to next step.		
<input type="checkbox"/>	NO: Verify the remote programming, the RF connections and check the remote start error codes. Repeat the test and call technical support, if the problem persists.		

CHECKLIST - WITH OEM KEYFOB

1	WARNING: Vehicle engine will start many times. Test in a well ventilated area.
2	Close all vehicle doors, hood and trunk.
3	Press LOCK button three times [3x] rapidly on the OEM keyfob to remote start vehicle.
	Question 1: Does the vehicle remote start?
<input type="checkbox"/>	YES: Go to next step.
<input type="checkbox"/>	NO: The module doesn't detect OEM remote lock button from the vehicle communication network. Check all connections, repeat the test and call technical support, if the problem persists.
4	Press LOCK button three times [3x] rapidly on the OEM keyfob to shut down vehicle.
	Question 2: Does the vehicle shut down?
<input type="checkbox"/>	YES: Go to next step.
<input type="checkbox"/>	NO: Repeat step. If the problem persists, press on the brake pedal once [1x] to shut down the vehicle and call technical support.
5	RAP Shutdown test
	Question 3: Did the radio, interior controls, and headlights turn off within 60 seconds after remote start shutdown?
<input type="checkbox"/>	YES: Go to next step.
<input type="checkbox"/>	NO: Verify the RAP SHUTDOWN connections as illustrated in the wiring diagram. Repeat the test and call technical support, if the problem persists.
6	Open hood.
7	If not already installed, affix the mandatory orange warning sticker under the hood and proceed to next step.
8	Press LOCK button three times [3x] rapidly on the OEM keyfob to remote start vehicle.
	Question 4: Does the vehicle remote start?
<input type="checkbox"/>	YES: The vehicle is not equipped with a factory hood pin. Install a mandatory aftermarket hood switch, then repeat the test.
<input type="checkbox"/>	NO: Go to next step.
9	Close hood.
10	Enter vehicle and close the doors.
11	Press LOCK button three times [3x] rapidly on the OEM keyfob to remote start vehicle.
12	Wait for the vehicle to start.
13	Press brake pedal.
	Question 5: Does the vehicle shut down?
<input type="checkbox"/>	YES: Go to next step.
<input type="checkbox"/>	NO: The module does NOT detect the brake pedal signal. Press LOCK button three times [3x] rapidly on the OEM keyfob to shut down, check the brake connection as illustrated in the wiring diagram, if applicable, and call technical support.
14	Exit vehicle.
15	Installation checklist completed.



INSTALL GUIDE

2016-2018 MAZDA MX-5 PTS MT

DOCUMENT NUMBER

REVISION DATE

20180829

FIRMWARE

ADS-RSA-MA3-[HCX000A]

HARDWARE

HCX000A

ACCESSORIES

ATTENTION: TO COMPLETE THIS INSTALLATION SOME ACCESSORIES MAY BE REQUIRED. VISIT OUR WEBSITE TO SEE ALL THE REQUIRED ACCESSORIES FOR YOUR VEHICLE.

TERMS OF USE

Automotive Data Solutions Inc. ("ADS") products are strictly intended for installation by Certified Technicians who are employed by a registered business specialized in the installation of automotive aftermarket electronics products. Prior to beginning installation of an ADS product in a vehicle, it is the Certified Technician's responsibility to review the most current Product Guide, Install Guide and vehicle-specific notes available in Weblink®. ADS is not responsible for any damages whatsoever, including but not limited to any consequential damages, incidental damages, damages for loss of time, loss of earnings, loss of profit, commercial loss, loss of economic opportunity and the like that may or may not have resulted from the use, misuse, improper installation or operation of its products. ADS reserves itself the right to suspend any Weblink® account without notice and decline to offer technical support to non-Certified Technicians, non-compliant Certified Technicians or end users.



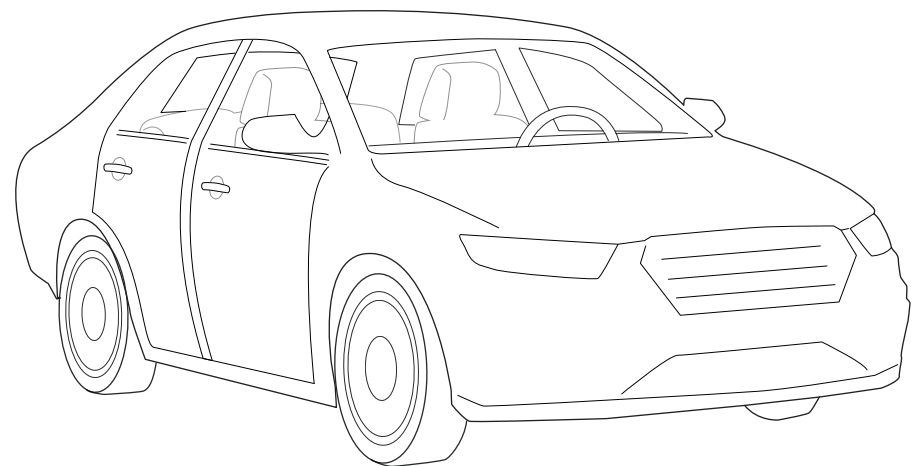
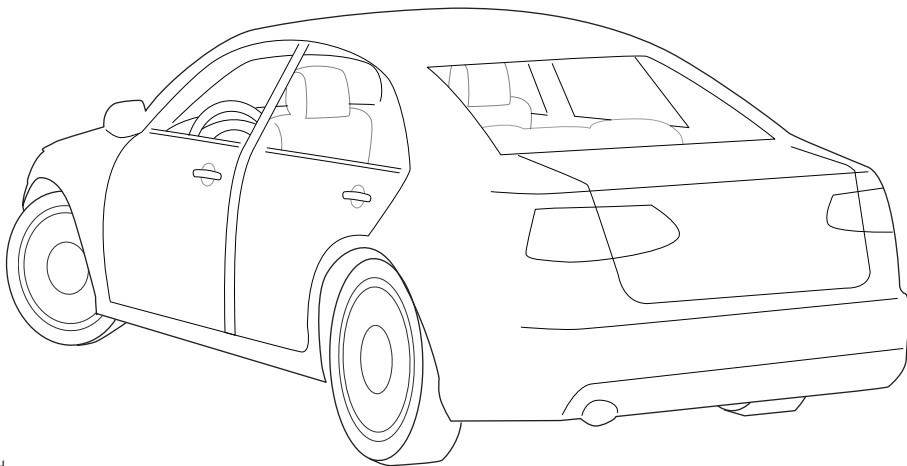
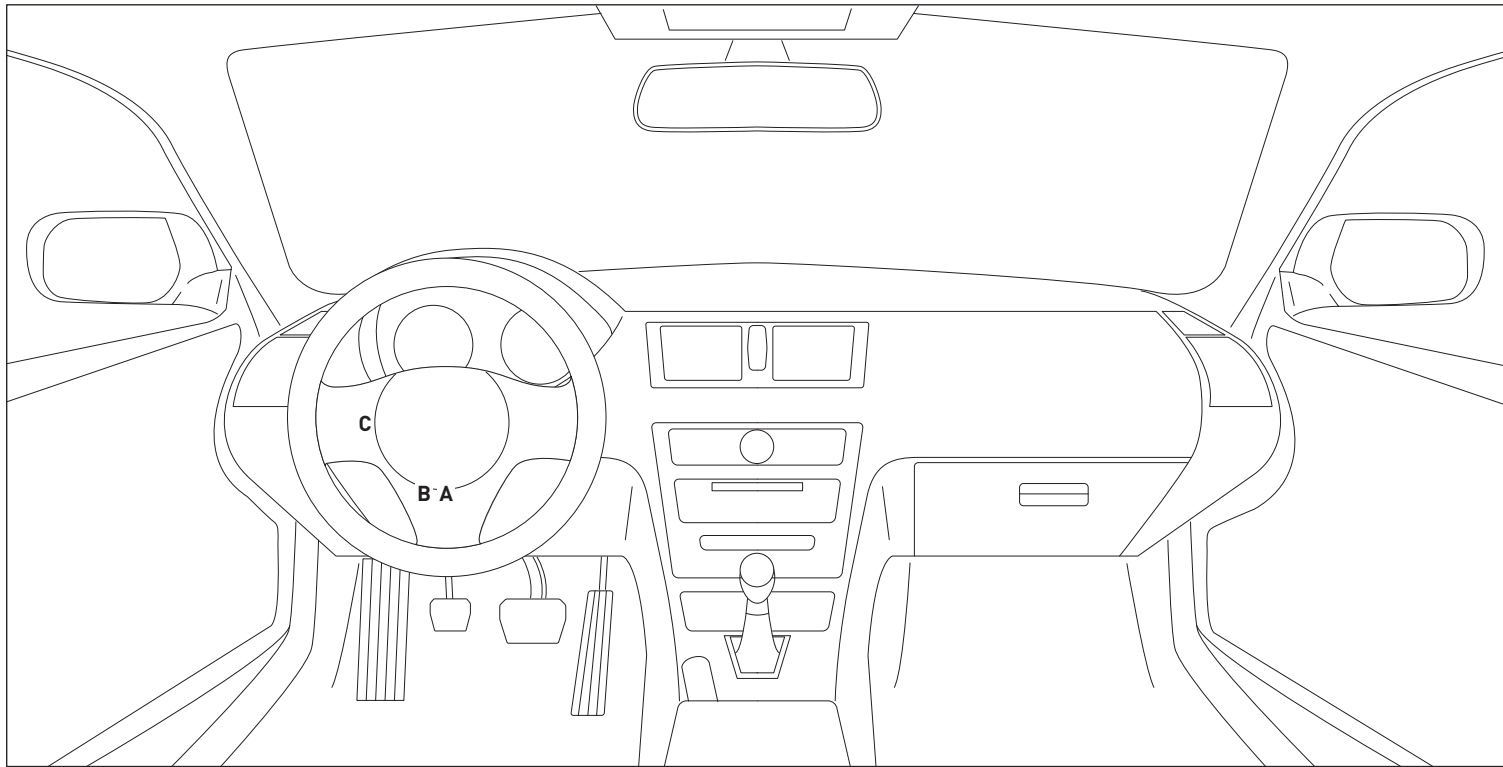

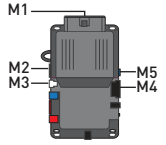

MANDATORY STEPS FOR MANUAL TRANSMISSION:
 1- DO NOT CUT THE LOOP.
 2- CONNECT THE MANUAL TRANSMISSION DIGITAL SENSOR.
 3- SEE THE PRODUCT GUIDE FOR MORE INFORMATION.

DISCONNECT BATTERY BEFORE ATTEMPTING INSTALLATION

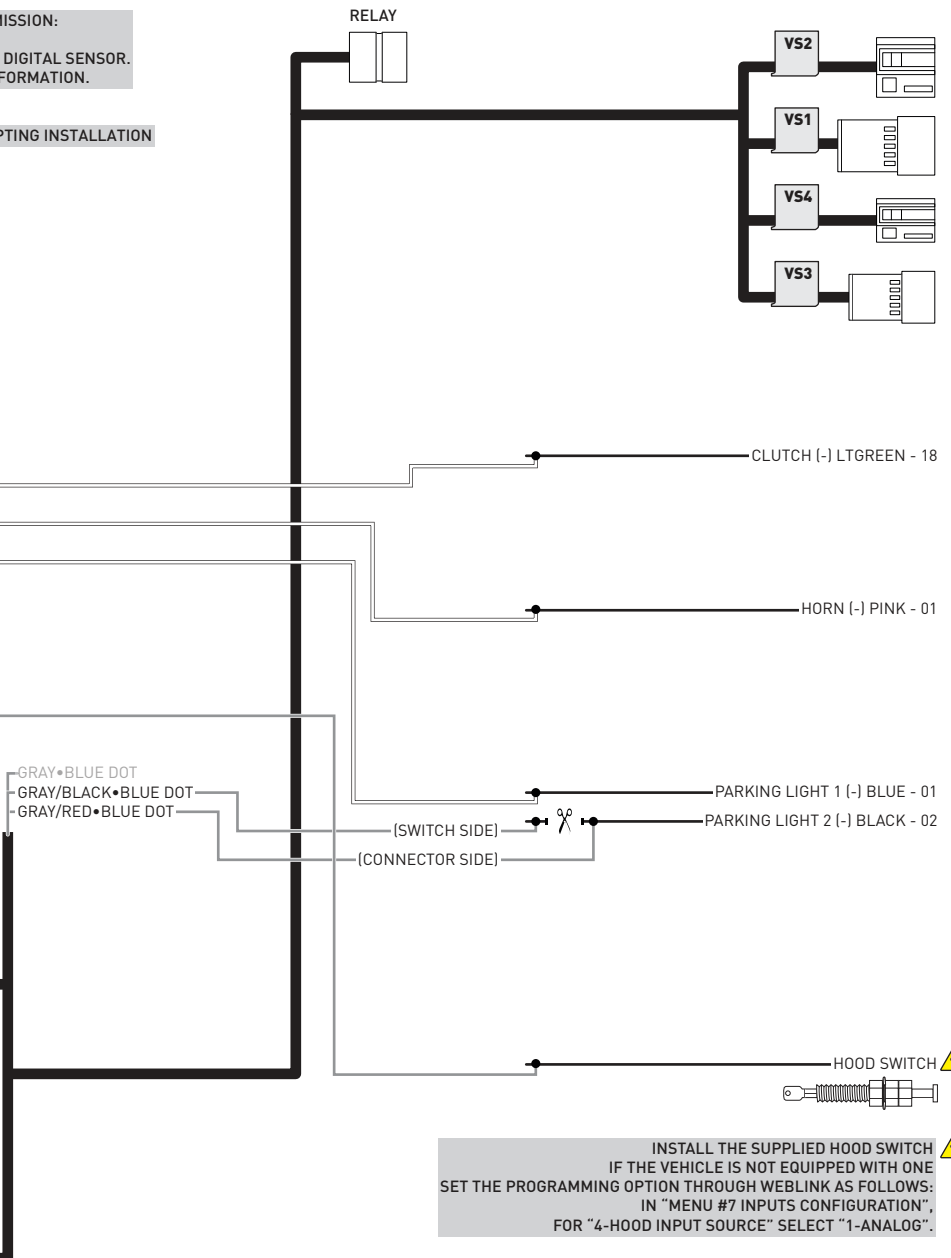
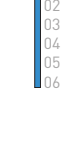

INSTALL THE SUPPLIED HOOD SWITCH IF THE VEHICLE IS NOT EQUIPPED WITH ONE SET THE PROGRAMMING OPTION THROUGH WEBLINK AS FOLLOWS: IN "MENU #7 INPUTS CONFIGURATION", FOR "4-HOOD INPUT SOURCE" SELECT "1-ANALOG".

START STOP UNIT, UNDER STEERING COLUMN (A)

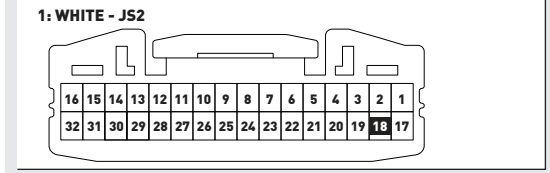
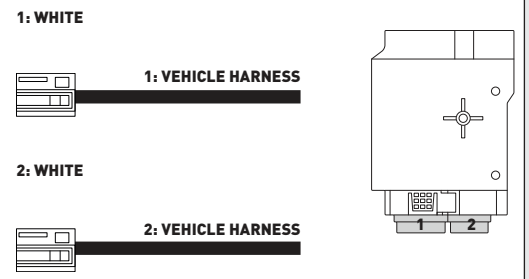

CLOCK SPRING (B)

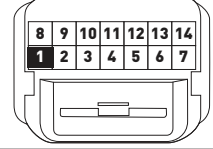

PARKING LIGHTS SWITCH, LEFT OF STEERING COLUMN (C)

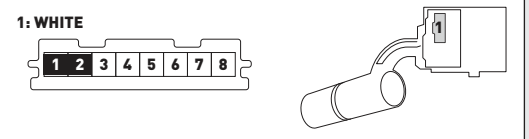

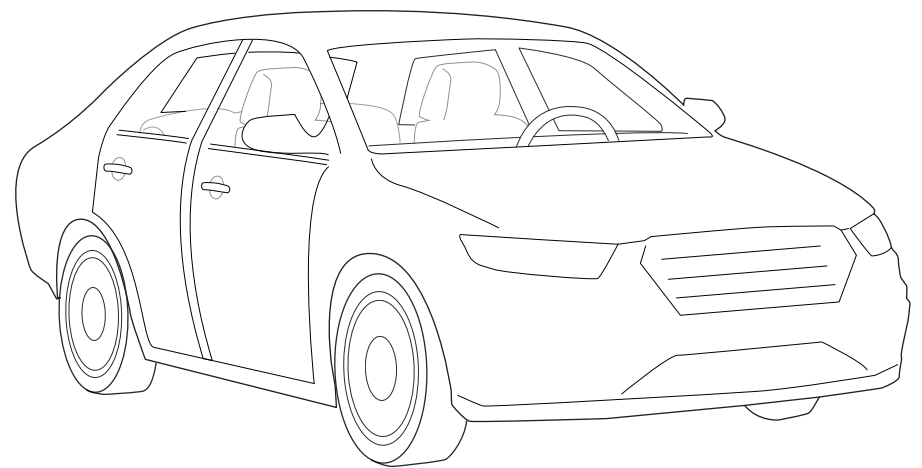
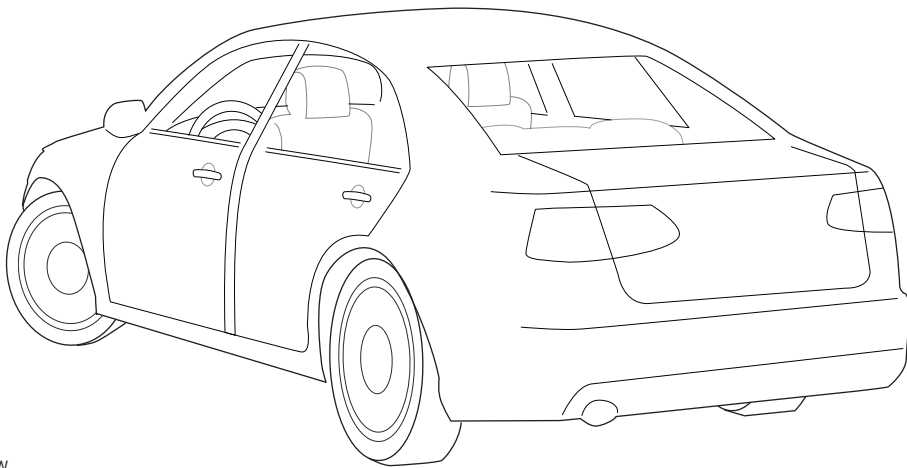
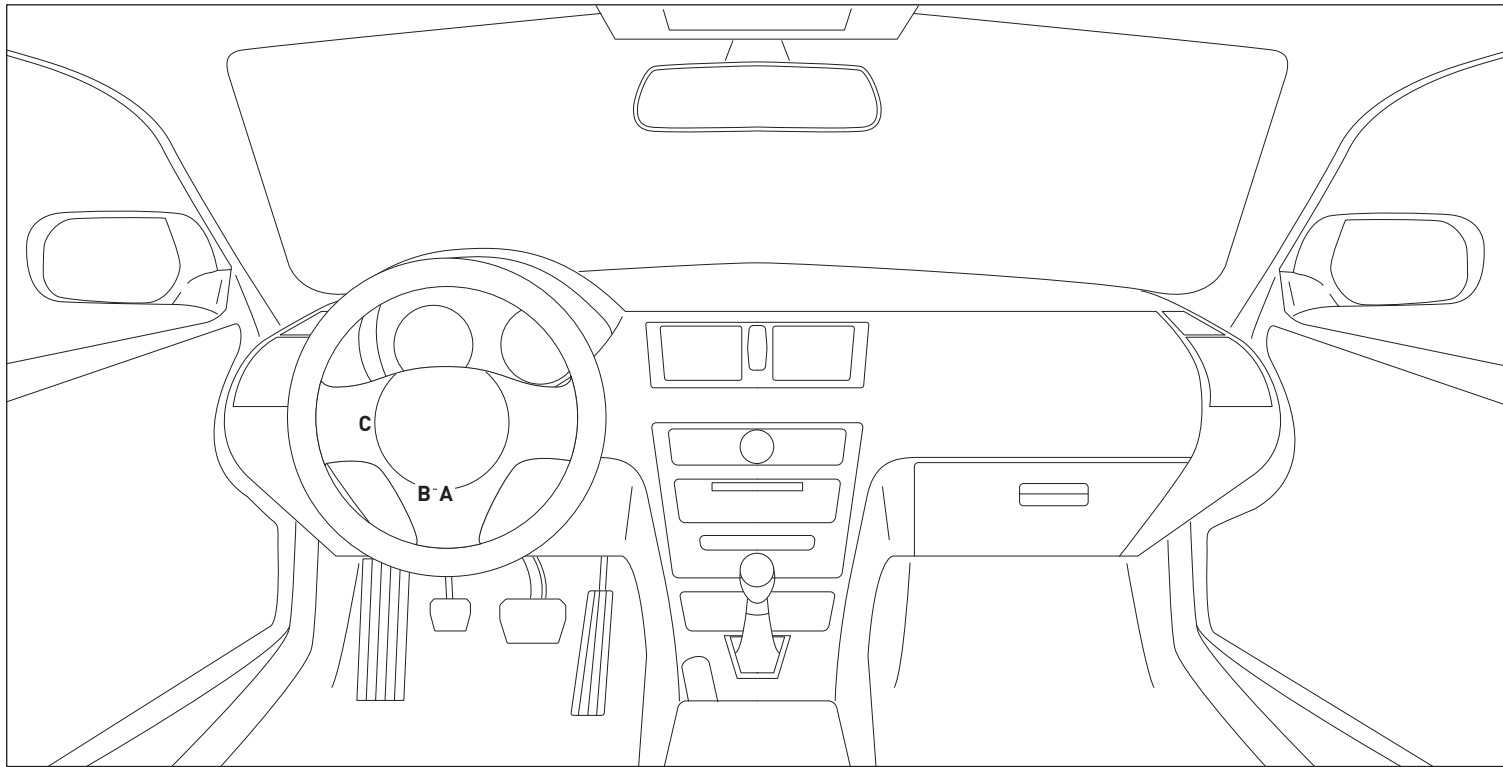

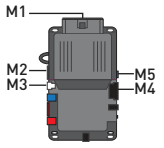

MANDATORY STEPS FOR MANUAL TRANSMISSION:
 1- DO NOT CUT THE LOOP.
 2- CONNECT THE MANUAL TRANSMISSION DIGITAL SENSOR.
 3- SEE THE PRODUCT GUIDE FOR MORE INFORMATION.

DISCONNECT BATTERY BEFORE ATTEMPTING INSTALLATION

- M1**
- 01 ORANGE
 - 02 RED
 - 03 PURPLE
 - 04 PINK/WHITE
 - 05 PINK
 - 06 WHITE
 - 07 RED
 - 08 BLACK

- M2**
- 01 GREEN•BLACK DOT
 - 02 BLUE•BLACK DOT
 - 03 RED/WHITE•BLACK DOT
 - 04 GREEN/WHITE•BLACK DOT
 - 05 GREEN/BLACK•BLACK DOT
 - 06 BLUE/WHITE•BLACK DOT
 - 07 EMPTY
 - 08 WHITE/PURPLE•BLACK DOT - STARTER (-) OUTPUT
 - 09 PURPLE/BLACK•BLACK DOT
 - 10 WHITE/BLACK•BLACK DOT - HORN (-) OUTPUT
 - 11 BROWN/BLACK•BLACK DOT
 - 12 WHITE•BLACK DOT - PARKING LIGHT 1 (-) OUTPUT

- M3**
- 01 BROWN•SILVER DOT
 - 02 BLACK/WHITE•SILVER DOT
 - 03 PURPLE•SILVER DOT
 - 04 GREEN•SILVER DOT
 - 05 PURPLE/WHITE•SILVER DOT
 - 06 WHITE/BLUE•SILVER DOT
 - 07 GRAY•SILVER DOT - HOOD STATUS (-) INPUT
 - 08 BLUE•SILVER DOT
 - 09 GRAY/BLACK•SILVER DOT
 - 10 EMPTY

- M4**
- 01 EMPTY
 - 02 EMPTY
 - 03 BROWN/RED - CANH 1
 - 04 BROWN/YELLOW - CANL 1
 - 05 BLUE/RED
 - 06 BLUE/YELLOW
 - 07 EMPTY
 - 08 ORANGE
 - 09 YELLOW
 - 10 EMPTY
 - 11 GRAY/RED - PTS (-) OUTPUT
 - 12 GRAY/YELLOW
 - 13 GREEN/RED - KEYLESS (DATA)
 - 14 ORANGE/WHITE
 - 15 BROWN
 - 16 ORANGE/BLACK
 - 17 PINK - IGNITION (+) IN/OUT
 - 18 PURPLE - STARTER (+) OUTPUT
 - 19 RED - 12V (+) INPUT
 - 20 BLACK - GROUND (-)

- M5**
- 01 GRAY/BLACK•BLUE DOT - PARKING LIGHT 2 (-) SWITCH SIDE
 - 02 WHITE/BLACK•BLUE DOT - IGNITION (+) VEHICLE SIDE
 - 03 GRAY/RED•BLUE DOT - PARKING LIGHT 2 (-) CONNECTOR SIDE
 - 04 WHITE/RED•BLUE DOT - IGNITION (+) CONNECTOR SIDE
 - 05 GRAY•BLUE DOT
 - 06 WHITE•BLUE

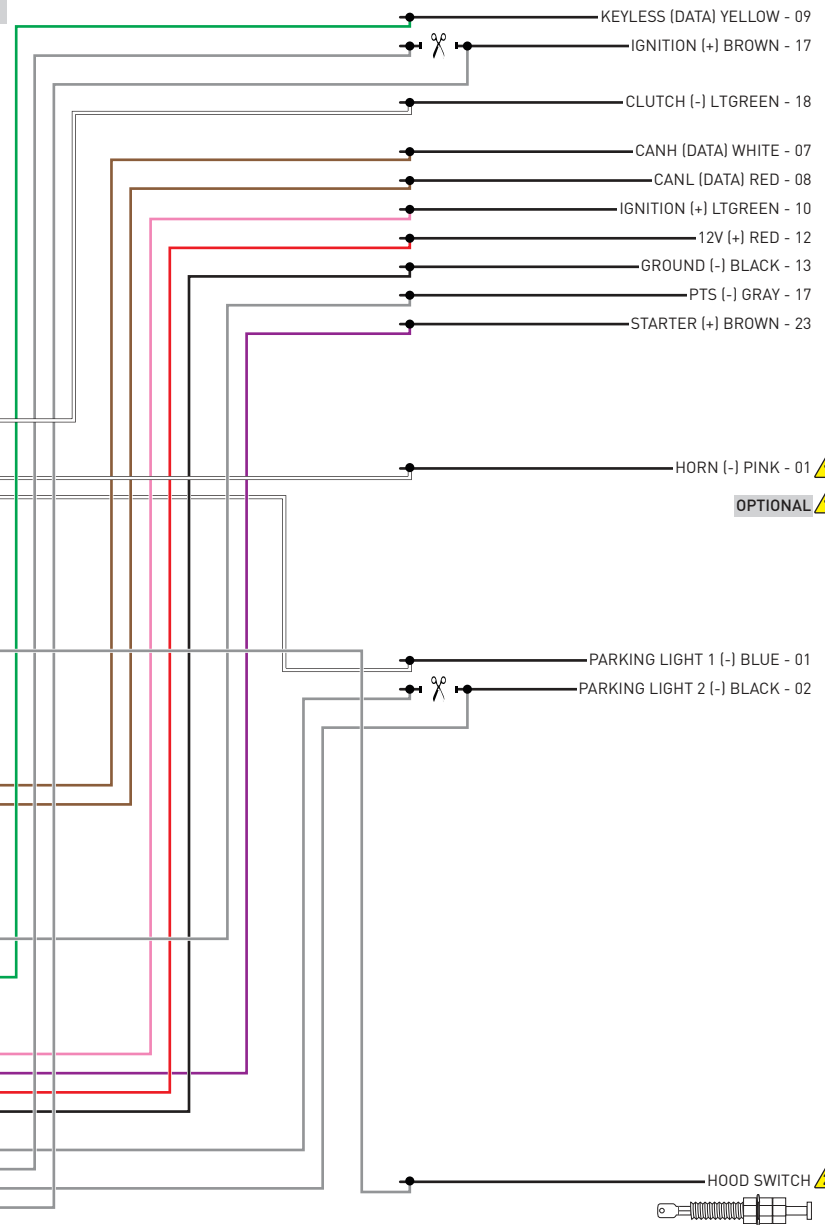

START STOP UNIT, UNDER STEERING COLUMN (A)

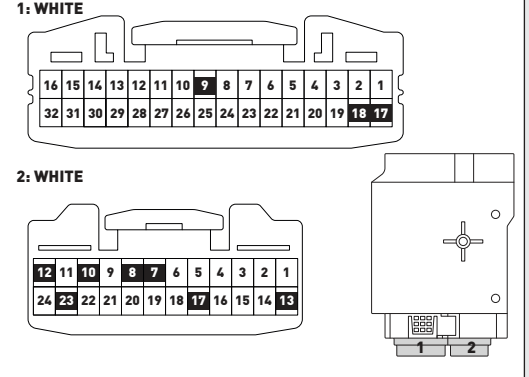

CLOCK SPRING (B)

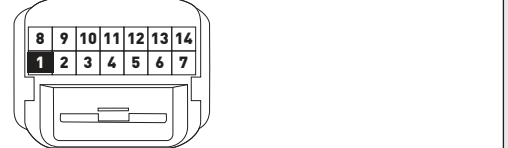

PARKING LIGHTS SWITCH, LEFT OF STEERING COLUMN (C)

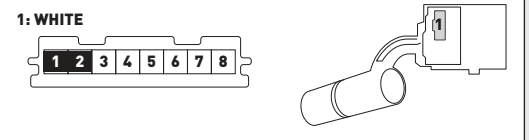

INSTALL THE SUPPLIED HOOD SWITCH IF THE VEHICLE IS NOT EQUIPPED WITH ONE SET THE PROGRAMMING OPTION THROUGH WEBLINK AS FOLLOWS: IN "MENU #7 INPUTS CONFIGURATION", FOR "4-HOOD INPUT SOURCE" SELECT "1-ANALOG".

>>  WARNING: All vehicle doors must be closed and locked prior to remote start sequence.

01  Set ignition to ON position.

02  Wait, LED 1 will turn solid RED to confirm that the ignition is ON.

03  Wait 10 seconds, LED 1 will flash GREEN rapidly.

04  Set ignition to OFF position.

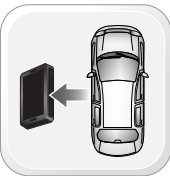
05  WARNING: Disconnect power last. Disconnect module from vehicle.

06  Connect module to computer and proceed with extended programming.

07  Connect power first. Connect module to vehicle.

08  Set ignition to ON position.

09  Wait, LED 1 will turn solid RED to confirm that the ignition is ON.

10  Wait, LED 1 will turn solid GREEN for 2 seconds.

11  Set ignition to OFF position.

>>  If vehicle is equipped with power liftgate: open and close the power liftgate with OEM keyfob.

12  START vehicle for 15 seconds.

13  Press and hold the brake pedal.

14  Press and release the module's programming button.

15  Release the brake pedal.

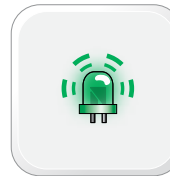
16  Wait, LED 2 will flash GREEN. Module Programming Procedure completed.

>>



All vehicle doors must be closed and locked prior to remote start sequence.

01



Time restriction. Complete steps 2 to 5 within 45 seconds.

02



Press unlock on OEM or aftermarket remote or request switch.

03



Open driver door and enter vehicle.

04



Close driver door.

05



Press and release BRAKE pedal.

06



Take over procedure completed.

>>



Failure to follow procedure will result in vehicle engine shutdown.

CHECKLIST - WITH AFTERMARKET KEYFOB

1	WARNING: Vehicle engine will start many times. Test in a well ventilated area.
2	Close all vehicle doors, hood and trunk.
3	Press the LOCK button once [1x] on the aftermarket keyfob.
	Question 1: Do the doors lock?
<input type="checkbox"/>	YES: Go to next step.
<input type="checkbox"/>	NO: Verify the remote programming, the RF connections and the wired door lock/unlock connections as illustrated in the wiring diagram, if applicable. Repeat the test and call technical support, if the problem persists.
4	Press the UNLOCK button once [1x] on the aftermarket keyfob.
	Question 2: Do the doors unlock?
<input type="checkbox"/>	YES: Go to next step.
<input type="checkbox"/>	NO: Verify the remote programming, the RF connections and the wired door lock/unlock connections as illustrated in the wiring diagram, if applicable. Repeat the test and call technical support, if the problem persists.
5	Press the TRUNK release button once [1x] on the aftermarket keyfob if supported.
	Question 3: Does the trunk or hatch open/unlock?
<input type="checkbox"/>	YES: Close trunk or hatch and go to next step.
<input type="checkbox"/>	NO: Verify the remote programming, the RF connections and the wired trunk/hatch connections as illustrated in the wiring diagram, if applicable. Repeat the test and call technical support, if the problem persists.
6	Press the AUX 1 button once [1x] on the aftermarket keyfob if supported.
	Question 4: Does the driver side sliding door open?
<input type="checkbox"/>	YES: Press the AUX 1 button once [1x] to close the driver sliding door and go to next step.
<input type="checkbox"/>	NO: Verify the remote programming and the RF connections. Repeat the test and call technical support, if the problem persists.
7	Press the AUX 2 button once [1x] on the aftermarket keyfob if supported.
	Question 5: Does the passenger side sliding door open?
<input type="checkbox"/>	YES: Press the AUX 2 button once [1x] to close the passenger sliding door and go to next step.
<input type="checkbox"/>	NO: Verify the remote programming and the RF connections. Repeat the test and call technical support, if the problem persists.
8	Press the START/STOP button once [1x] on the aftermarket keyfob to remote start vehicle.
	Question 6: Does the vehicle remote start?
<input type="checkbox"/>	YES: Go to next step.
<input type="checkbox"/>	NO: Verify the remote programming, the RF connections and check the remote start error codes. Repeat the test and call technical support, if the problem persists.

9	Press the START/STOP button once [1x] on the aftermarket keyfob to shut down vehicle.
	Question 7: Does the vehicle shut down?
<input type="checkbox"/>	YES: Go to next step.
<input type="checkbox"/>	NO: Repeat step. If problem persists, press the brake pedal once [1x] to shut down the vehicle and call technical support.
10	RAP and auto light shutdown test
	Question 8: Did the radio, interior controls and headlights turn off within 60 seconds after remote start shutdown?
<input type="checkbox"/>	YES: Go to next step.
<input type="checkbox"/>	NO: Verify the RAP SHUTDOWN connections as illustrated in the wiring diagram. Repeat the test and call technical support if the problem persists.
11	Open hood.
12	If not already installed, affix the mandatory orange warning sticker under the hood and proceed to next step.
13	Press the START/STOP button once [1x] on the aftermarket keyfob to remote start vehicle.
	Question 9: Does the vehicle remote start?
<input type="checkbox"/>	YES: The vehicle is not equipped with a factory hood pin. Install a mandatory aftermarket hood switch, then repeat the test.
<input type="checkbox"/>	NO: Go to next step.
14	Close hood.
15	Enter vehicle and close the doors.
16	Press the START/STOP button once [1x] on the aftermarket keyfob to remote start vehicle.
17	Wait for the vehicle to start.
18	Press brake pedal.
	Question 10: Does the vehicle shut down?
<input type="checkbox"/>	YES: Go to next step.
<input type="checkbox"/>	NO: The module does NOT detect the brake pedal signal. Press the START/STOP button once [1x] on the aftermarket keyfob to shut down vehicle, check connection as illustrated in the wiring diagram, if applicable, and call technical support.
19	Exit vehicle.
20	Installation checklist completed.

CHECKLIST - WITH OEM KEYFOB

1	WARNING: Vehicle engine will start many times. Test in a well ventilated area.
2	Close all vehicle doors, hood and trunk.
3	Press LOCK button three times [3x] rapidly on the OEM keyfob to remote start vehicle.
	Question 1: Does the vehicle remote start?
<input type="checkbox"/>	YES: Go to next step.
<input type="checkbox"/>	NO: The module doesn't detect OEM remote lock button from the vehicle communication network. Check all connections, repeat the test and call technical support, if the problem persists.
4	Press LOCK button three times [3x] rapidly on the OEM keyfob to shut down vehicle.
	Question 2: Does the vehicle shut down?
<input type="checkbox"/>	YES: Go to next step.
<input type="checkbox"/>	NO: Repeat step. If the problem persists, press on the brake pedal once [1x] to shut down the vehicle and call technical support.
5	RAP Shutdown test
	Question 3: Did the radio, interior controls, and headlights turn off within 60 seconds after remote start shutdown?
<input type="checkbox"/>	YES: Go to next step.
<input type="checkbox"/>	NO: Verify the RAP SHUTDOWN connections as illustrated in the wiring diagram. Repeat the test and call technical support, if the problem persists.
6	Open hood.
7	If not already installed, affix the mandatory orange warning sticker under the hood and proceed to next step.
8	Press LOCK button three times [3x] rapidly on the OEM keyfob to remote start vehicle.
	Question 4: Does the vehicle remote start?
<input type="checkbox"/>	YES: The vehicle is not equipped with a factory hood pin. Install a mandatory aftermarket hood switch, then repeat the test.
<input type="checkbox"/>	NO: Go to next step.
9	Close hood.
10	Enter vehicle and close the doors.
11	Press LOCK button three times [3x] rapidly on the OEM keyfob to remote start vehicle.
12	Wait for the vehicle to start.
13	Press brake pedal.
	Question 5: Does the vehicle shut down?
<input type="checkbox"/>	YES: Go to next step.
<input type="checkbox"/>	NO: The module does NOT detect the brake pedal signal. Press LOCK button three times [3x] rapidly on the OEM keyfob to shut down, check the brake connection as illustrated in the wiring diagram, if applicable, and call technical support.
14	Exit vehicle.
15	Installation checklist completed.